

Combi Steam Built-in Oven

User manual

NQ50T9939BD



SAMSUNG

Contents

Using this manual	3	Cooking Smart	26
The following symbols are used in this user manual	3	Auto Cook	26
Safety instructions	3	Auto Defrost	30
Important safety precautions	3	Manual cooking	31
Correct Disposal of This Product (Waste Electrical & Electronic Equipment)	6	Test dishes	38
Installation	7	Maintenance	39
What's included	7	Cleaning	39
Installation instructions	8	Replacement (repair)	40
Install in the cabinet	8	Care against an extended period of disuse	40
Before you start	11	Troubleshooting	40
Control panel	11	Checkpoints	40
Initial settings	11	Information codes	44
Side racks	12	Technical specifications	45
Water reservoir	13	Appendix	45
Operations	14	Product data sheet	45
Oven modes	14	Open Source Announcement	46
Steam assisted modes	16		
Special Function	18		
Auto Cook	19		
Auto Defrost	20		
Favourites	20		
Timer	21		
Cleaning	22		
Settings	24		
Lock	25		

Using this manual

Thank you for choosing SAMSUNG Built-In Oven.
This User Manual contains important information on safety and instructions intended to assist you in the operation and maintenance of your appliance. Please take the time to read this User Manual before using your oven and keep this book for future reference.

The following symbols are used in this user manual

WARNING

Hazards or unsafe practices that may result in **severe personal injury, death and/or property damage**.

CAUTION

Hazards or unsafe practices that may result in **personal injury and/or property damage**.

NOTE

Useful tips, recommendations, or information that helps users manipulate the product.

Safety instructions

Installation of this oven must be performed only by a licensed electrician. The installer is responsible for connecting the appliance to the mains power supply in observance of the relevant safety recommendations.

Important safety precautions

WARNING

This appliance is not intended for use by persons (including children) with reduced physical, sensory or mental capabilities, or lack of experience and knowledge, unless they have been given supervision or instruction concerning use of the appliance by a person responsible for their safety.

Children should be supervised to ensure that they do not play with the appliance.

The means for disconnection must be incorporated in the fixed wiring in accordance with the wiring rules.

This Appliance should be allowed to disconnection from the supply after installation. The disconnection may be achieved by having the plug accessible or by incorporating a switch in the fixed wiring in accordance with the wiring rules.

If the supply cord is damaged, it must be replaced by the manufacturer, its service agent or similarly qualified persons in order to avoid a hazard.

Safety instructions

The method of fixing stated is not to depend on the use of adhesives since they are not considered to be a reliable fixing means.

This appliance can be used by children aged from 8 years and above and persons with reduced physical, sensory or mental capabilities or lack of experience and knowledge if they have been given supervision or instruction concerning use of the appliance in a safe way and understand the hazards involved. Children shall not play with the appliance. Cleaning and user maintenance shall not be made by children without supervision. Keep the appliance and its cord out of reach of children less than 8 years.

During use the appliance becomes hot. Care should be taken to avoid touching heating elements inside the oven.

WARNING: Accessible parts may become hot during use. Young children should be kept away.

Do not use harsh abrasive cleaners or sharp metal scrapers to clean the oven door glass since they can scratch the surface, which may result in shattering of the glass.

If this appliance has cleaning function, excess spillage must be removed before cleaning and all utensils should not be left in the oven during steam cleaning or self cleaning. The cleaning function depends on the model.

If this appliance has cleaning function, during cleaning conditions the surfaces may get hotter than usual and children should be kept away. The cleaning function depends on the model.

Only use the temperature probe recommended for this oven. (Meat probe model only)

A steam cleaner is not to be used.

WARNING: Ensure that the appliance is switched off before replacing the lamp to avoid the possibility of electric shock.

The appliance must not be installed behind a decorative door in order to avoid overheating.

WARNING: The appliance and its accessible parts become hot during use. Care should be taken to avoid touching heating elements. Children less than 8 years of age shall be kept away unless continuously supervised.

CAUTION: The cooking process has to be supervised. A short term cooking process has to be supervised continuously.

The door or the outer surface may get hot when the appliance is operating.

The temperature of accessible surfaces may be high when the appliance is operating. The surfaces are liable to get hot during use.

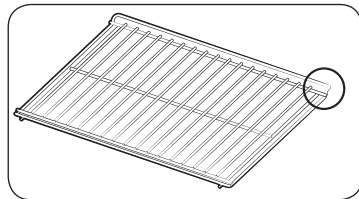

Please put the bent up frame side to the back, in order to support the repositioning when cooking big loads. (Depending on model)

⚠ CAUTION

If the oven has been damaged in transport, do not connect it.

This appliance must be connected to the mains power supply only by a specially licensed electrician.

In the event of a fault or damage to the appliance, do not attempt to operate it. Repairs should be performed by a licensed technician only. Improper repair may result in considerable danger to you and others. If your oven needs repair, contact a SAMSUNG Service center or your dealer.

Electrical leads and cables should not be allowed to touch the oven.

The oven should be connected to the mains power supply by means of an approved circuit breaker or fuse. Never use multiple plug adapters or extension leads.

The power supply of the appliance should be turned off when it is being repaired or cleaned.

Take care when connecting electrical appliances to sockets near the oven.

If this appliance has a vapour or steam cooking function, do not operate this appliance when the water supply cartridge is damaged. (Vapour or steam function model only)

When the cartridge is cracked or broken, do not use it and contact your nearest service center. (Vapour or steam function model only)

This oven has been designed only for the cooking of household foods.

During use, the oven interior surfaces become hot enough to cause burns. Do not touch heating elements or interior surfaces of the oven until they have had time to cool.

Never store flammable materials in the oven.

The oven surfaces become hot when the appliance is operated at a high temperature for an extended period of time.

When cooking, take care when opening the oven door as hot air and steam can escape rapidly.

When cooking dishes that contain alcohol, the alcohol may evaporate due to the high temperatures and the Vapour can catch fire if it comes into contact with a hot part of the oven.

For your safety, do not use high-pressure water cleaners or steam jet cleaners.

Children should be kept at a safe distance when the oven is in use.

Frozen foods such as pizzas should be cooked on the big grid. If the baking tray is used, it may become deformed due to the great variation in temperatures.

Do not pour water into the bottom of the oven when it is hot. This could cause damage to the enamel surface.

The oven door must be closed during cooking.

Do not line the bottom of the oven with aluminum foil and do not place any baking trays or tins on it. The aluminum foil blocks the heat, which may result in damage to the enamel surfaces and cause poor cooking results.

Fruit juices will leave stains, which can become permanent on the enamel surfaces of the oven.

When cooking very moist cakes, use the deep pan.

Do not rest bakeware on the open oven door.



Safety instructions

Keep children away from the door when opening or closing it as they may bump themselves on the door or catch their fingers in the door.

Do not step, lean, sit or place heavy items on the door.

Do not open the door with unnecessarily strong force.

WARNING: Do not disconnect the appliance from the main power supply even after the cooking process is completed.

WARNING: Do not leave the door open while oven is cooking.



Correct Disposal of This Product (Waste Electrical & Electronic Equipment)



(Applicable in countries with separate collection systems)

This marking on the product, accessories or literature indicates that the product and its electronic accessories (e.g. charger, headset, USB cable) should not be disposed of with other household waste at the end of their working life. To prevent possible harm to the environment or human health from uncontrolled waste disposal, please separate these items from other types of waste and recycle them responsibly to promote the sustainable reuse of material resources.

Household users should contact either the retailer where they purchased this product, or their local government office, for details of where and how they can take these items for environmentally safe recycling.

Business users should contact their supplier and check the terms and conditions of the purchase contract. This product and its electronic accessories should not be mixed with other commercial wastes for disposal.

For information on Samsung's environmental commitments and product-specific regulatory obligations, e.g. REACH, WEEE, Batteries, visit : samsung.com/uk/aboutsamsung/samsungelectronics/corporatecitizenship/data_corner.html



Installation

What's included

Make sure all parts and accessories are included in the product package. If you have a problem with the oven or accessories, contact a local Samsung customer centre or the retailer.

Oven at a glance

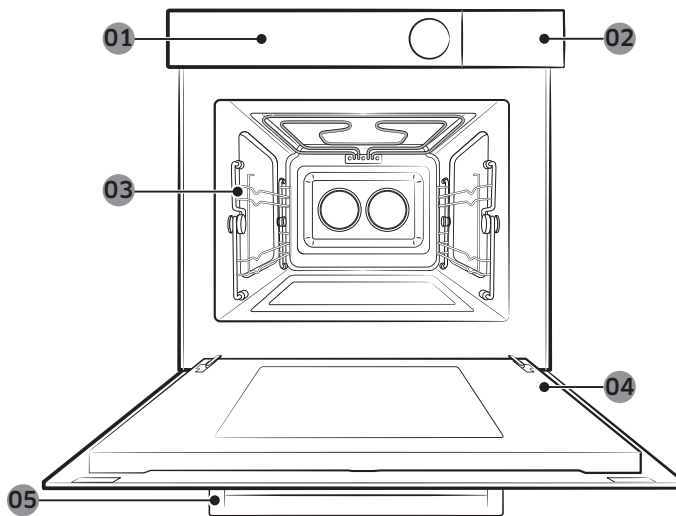

- | | | |
|------------------|--------------------|---------------|
| 01 Control panel | 02 Water reservoir | 03 Side racks |
| 04 Door | 05 Door handle | |

Accessories

The oven comes with different accessories that help you prepare different types of food.

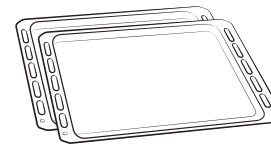

Baking trays

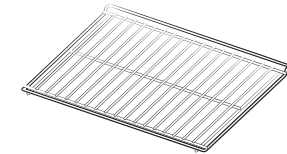

Oven rack

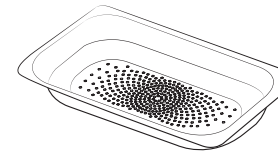

Steam dish

NOTE

See the **Cooking Smart** on page 26 to determine the appropriate accessory for your dishes.

Installation

Installation instructions

General technical information

Electrical Supply	230 V ~ 50 Hz	
Dimensions (W × H × D)	Set size	595 x 456 x 570 mm
	Built in size	560 x 446 x 549 mm

This appliance complies with EU regulations.

Disposal of packaging and appliance

Packaging is recyclable.

Packaging may consist of the following materials:

- cardboard;
- polyethylene film (PE);
- CFC-free polystyrene(PS rigid foam).

Please dispose of these materials in a responsible manner in accordance with government regulations.

The authorities can provide information on how to dispose of domestic appliances in a responsible manner.

Safety

- This appliance should only be connected by a qualified technician.
- The Oven is NOT designed for use in a commercial cooking setting.
- It should be used exclusively for cooking food in a home setting.
- The appliance is hot during and after use.
- Exercise caution when young children are present.

Electrical connection

The house mains to which the appliance is connected should comply with national and local regulations.

Appliance should allow to disconnection of the appliance from the supply after installation. The disconnection may be achieved by having the plug accessible or by incorporating a switch in the fixed wiring in accordance with the wiring rules.

Install in the cabinet

Kitchen cabinets in contact with the oven must be heatresistant up to 100 °C. Samsung will take no responsibility for damage of cabinets from the heat.

Required dimensions for installation

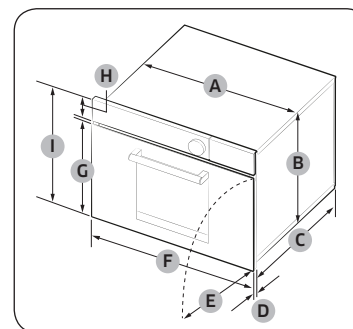

Oven (mm)

A	560	F	595
B	446	G	359.5
C	549	H	85
D	21	I	456
E	341		

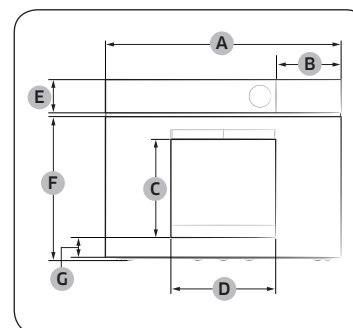

Oven (mm)

A	595	E	85
B	163	F	359.5
C	247	G	50
D	264		

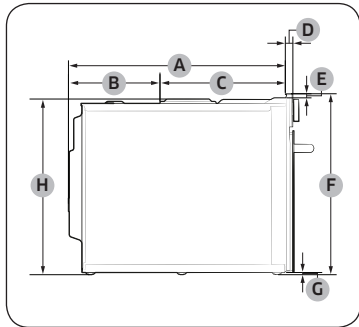

Oven (mm)

A	549	E	10
B	233	F	456
C	316	G	6
D	21	H	446

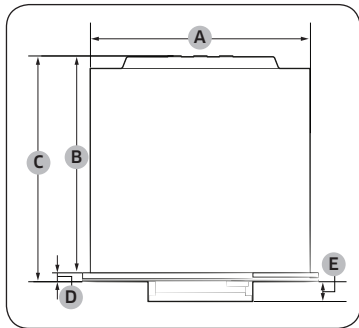

Oven (mm)

A	560	D	21
B	549	E	50
C	570		

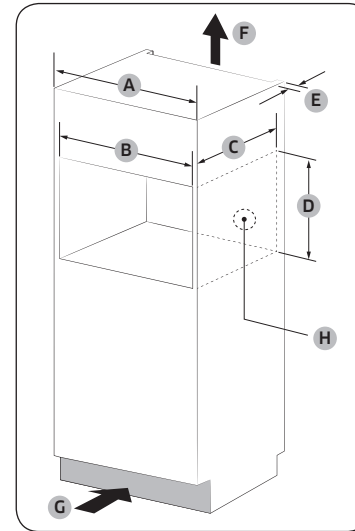

Built-in cabinet (mm)

A	600
B	Min. 564-568
C	Min. 550
D	Min. 446 / Max. 450
E	Min. 50
F	200 cm ²
G	200 cm ²
H	Space for power outlet (30 Ø Hole)

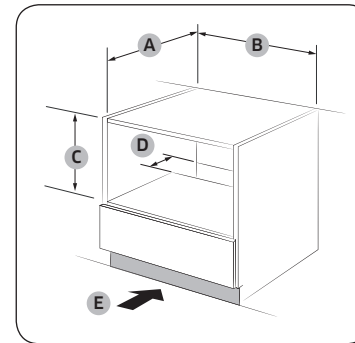

Under-sink cabinet (mm)

A	Min. 550
B	Min. 564 / Max. 568
C	Min. 446 / Max. 450
D	50
E	200 cm ²

NOTE

Minimum height requirement (C) is for oven installation alone.

Installation

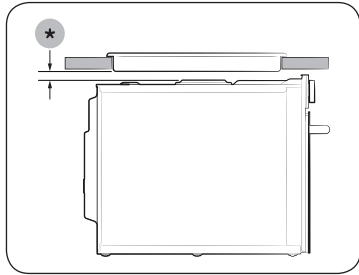

Installing with a hob

To install a hob on top of the oven, check the installation guide of the hob for the installation space requirement (*).

Mounting the oven

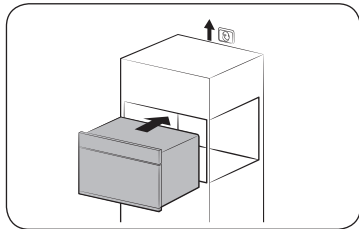

1. Slide the oven partly into the recess. Lead the connection cable to the power source.

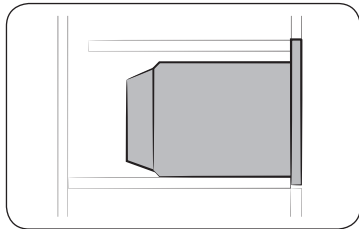

2. Slide the oven completely into the recess.

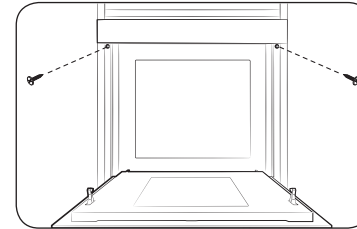

3. Fasten the oven using the two screws (4 x 25 mm) provided.

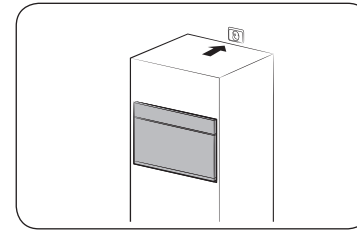

4. Make the electrical connection. Check that the appliance works.

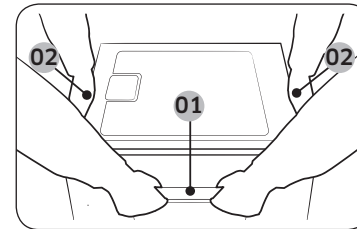

Be sure to hold the appliance with 2 side handles and door handle when unpacking the product.

- 01 Door handle
- 02 Side handle

After the installation is complete, remove the protective film, tape, and other packing material, and take out the provided accessories from inside of the oven. To remove the oven from the cabinet, first disconnect power to the oven and remove 2 screws on both sides of the oven.

Before you start

Control panel

The oven's control panel features a full touch display, dial knob and touch buttons to control the oven. Please read the following information to learn about the oven's control panel.

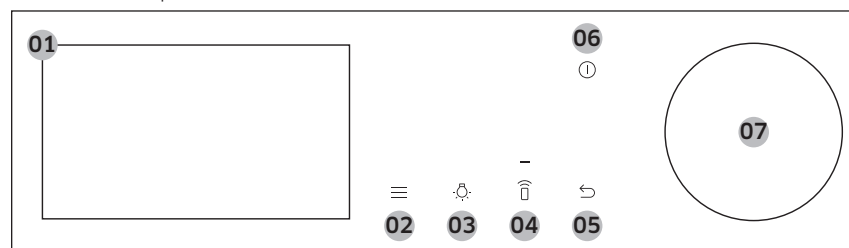

01 Full Touch Screen	Displays the menu, information, and cooking progress. You can swipe to navigate through the menus and lists. Tap the desired item to select.
02 Options	Tap to see the Options list.
03 Light	Tap to turn the oven light on or off.
04 Smart Control	Tap to turn the Smart Control function on or off. NOTE Easy Connection should be set prior to use this function.
05 Back	Tap to move to the previous screen.
06 Power	Tap to turn the screen on or off.
07 Dial Knob	Turn left and right to navigate through the menus and lists. An item will be underlined to show you where you are on the screen. Press to select the underlined item.

NOTE

Tapping on the display while wearing plastic or oven gloves may not operate properly.

Initial settings

When you turn on the oven for the first time, the Welcome screen appears with the Samsung logo. Follow the on-screen instructions to complete the initial settings. You can change the initial settings later by accessing the Settings screen.

1. On the welcome screen, tap **Start setup**.
2. Select the language.
 - a. Swipe the screen up and down and then tap the language.
 - b. Tap **Next**.
3. Agree with the "**Terms and Conditions**" and "**Privacy Policy**".
4. Connect your appliance to the SmartThings app.
 - a. On the Mobile Experience screen, tap **Next**.
 - b. Scan the QR code on the screen with your smartphone and follow the onscreen instruction on your phone to complete the connection.
 - If you do not wish to proceed this step, tap **Skip** and connect to the Wi-fi. (See **step 5**.)
 - c. Once you get the message that you are successfully connected, tap **OK** and set the time zone. (See **step 6**.)
5. Connect to the Wi-Fi network.

NOTE

If you do not wish to proceed this step, tap **Skip** and set the time zone, date, and time. (See **step 6~8**.)

- a. Tap your Wi-Fi network from the list.
 - If you do not see the list, tap **Scan**.
 - Tap **Add network** if you wish to add your Wi-Fi network manually.
 - If your Wi-Fi network is secured, enter the password using the keyboard, and then tap **Connect**.
- b. Once you are connected to the Wi-Fi network, tap **Next**.

Before you start

Before you start

6. Select the time zone.
 - a. Swipe the screen up and down and then tap your time zone.
 - b. Tap **Next**.
7. Set the date.
 - a. Tap the day, month, and year.
 - b. Tap **Next**.

NOTE

Skip this step if you have connected your appliance to the SmartThings app or Wi-Fi network.

8. Set the time.
 - a. Tap the hour and minute.
 - b. Tap **Next**.

NOTE

- Skip this step if you have connected your appliance to the SmartThings app or Wi-Fi network.
 - Default time format is set to 24-hour format. You can change the time format to 12-hour format in **Settings** menu.
9. Tap **Done** to complete the setting.
 - Guide for first use screen appears. You can tap **LEARN MORE** to see the guide or tap **LATER** to skip this step.

Setting the screen to stay always on

The screen automatically turns off after a certain time. If you want to set the screen to stay on all the time, follow the below instructions.

1. Touch the  button on the control panel, and then tap **Settings**.
2. On the Settings screen, tap **Display**.
3. On the Display screen, tap **Timeout**.
4. Swipe up to move down the list of options, and then tap **Always on**.

NOTE

- Energy consumption may increase depending on your setting.
- When the timeout setting is set to "**Always on**", the brightness of the LCD automatically changes to level 2 if there is no action for 3 minutes.
- "**Always on**" setting is available only when the screen saver is set to On.

Side racks

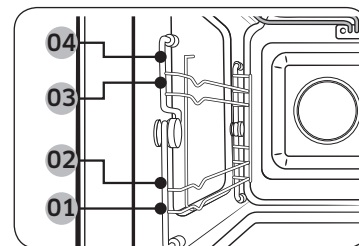

- 01 Level 1
- 02 Level 2
- 03 Level 3
- 04 Level 4

- Insert the accessory to the correct position inside of the oven.
- Take caution in removing cookware and/or accessories out of the oven. Hot meals or accessories can cause burns.

Water reservoir

The water reservoir is used for steam functions. Fill it with water in advance of steam cooking.

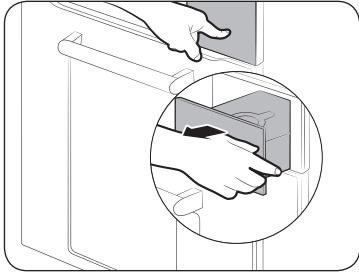

1. Locate the water reservoir in the top-right corner. Push in the reservoir to open and remove.

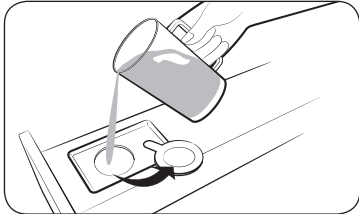

2. Open the reservoir cap, and fill the reservoir with 1000 ml of drinkable water.
3. Close the cap, and reinsert the reservoir.

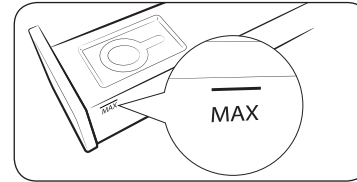

NOTE
Do not exceed the MAX line.

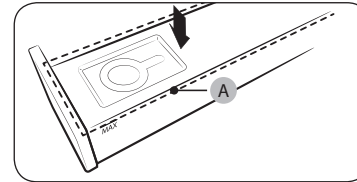

NOTE
Make sure the upper case (A) of the water reservoir is closed before using the oven.

Operations

Oven modes

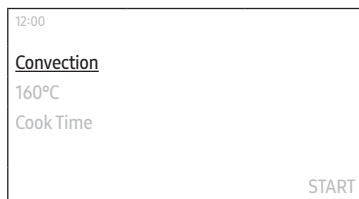

1. On the main screen, tap **Convection** to select the desired cook mode. (For detailed information of each mode, see “Oven mode descriptions” section on page 15.)

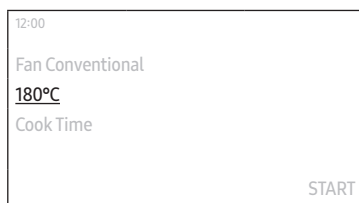

2. Set the desired temperature.
 - The default temperature and the temperature range differ depending on the cook mode.

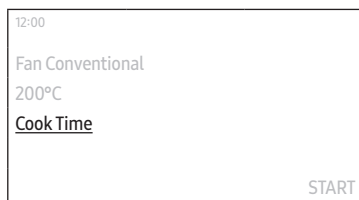

3. Tap **Cook Time** to set the desired cooking time.
 - Maximum cooking time is 10 hours.
4. After setting the cooking time, select the option you want to run at the end of cooking.
 - You can select **Oven Off**, **Keep Temp.**, or **Keep Warm**.
 - The Large Grill mode does not support the **Keep Warm** option.

NOTE

If you start cooking without setting the cooking time or set **Keep Temp.** for option, you must stop the oven manually.

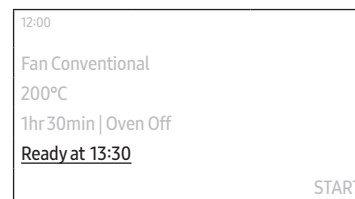

5. Tap **Ready at** to set the desired end time.
 - When you set the cooking time, the oven displays the time cooking will end. (Ex. **Ready at 13:30**)

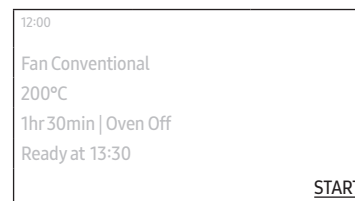

6. Tap **START**.
 - If you did not change the end time, the oven starts cooking immediately.
 - If you changed the end time, the oven will automatically adjust the start time to end cooking at the set time.

NOTE

- You can change the temperature and cooking time during cooking.
- During cooking, you can tap **Pause**, and then tap **OFF** to cancel cooking or tap **Continue** to keep cooking mode.
- When cooking is complete, **+5 mins** and **Add to Favourite** appears on the screen.
 - Tap **+5 mins** to extend the cooking for 5 more minutes.
 - Tap **Add to Favourite** to add the frequently used settings to the favourites list. You can easily apply the same settings next time you cook. (See “Favourites” section on page 20 for further information.)

Oven mode descriptions

Mode	Temperature range (°C)	Default temperature (°C)
Convection	40-250	160
	The rear heating element generates heat, which is evenly distributed by the convection fan. Use this mode for baking and roasting on different levels at the same time.	
Fan Conventional	40-250	180
	The heat is generated from the top and bottom heating elements with fans. This setting is suitable for baking and roasting.	
Large Grill	150-250	220
	The large-area grill emits heat. Use this mode for browning the tops of food (for example, meat, lasagne, or gratin).	
Fan Grill	40-250	180
	Two top heating elements generate heat, which is distributed by the fan. Use this mode for grilling meat or fish.	
Top Heat + Convection	40-250	180
	The top heating element generates heat, which is evenly distributed by the convection fan. Use this mode for roasting that requires a crispy top (for example, meat or lasagne).	

Mode	Temperature range (°C)	Default temperature (°C)
Bottom Heat + Convection	40-250	200
	The bottom heating element generates heat, which is evenly distributed by the convection fan. Use this mode for pizza, bread, or cake.	
Intensive Cook	40-250	220
	Intensive Cook activates all heating elements alternately to distribute heat evenly inside the oven. Use this mode for large recipes, such as large gratins or pies.	
Pro-Roasting	80-200	160
	Pro-Roasting runs an automatic pre-heating cycle until the oven temperature reaches 220 °C. Then, the top heating element and the convection fan start operating to sear food such as meat. After searing, the meat will be cooked at low temperatures. Use this mode for beef, poultry, or fish.	
Eco Convection	40-250	160
	Eco Convection uses the optimized heating system to save energy while cooking. The cooking times slightly increases, but the cooking results remain the same. Note that this mode does not require preheating.	
<p> NOTE Eco Convection mode of heating used to determine the energy efficiency class is in accordance with EN60350-1.</p>		

Operations

Steam assisted modes

⚠ CAUTION

Make sure the water reservoir is filled before using the steam assisted modes.

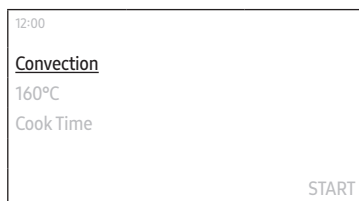

1. On the main screen, tap **Convection** to select the desired cook mode. (For detailed information of each mode, see “Steam assisted mode descriptions” section on page 17.)
 - If you selected **Steam Cook**, go to **step 4**. (Step 2~3 is not applicable for **Steam Cook**.)

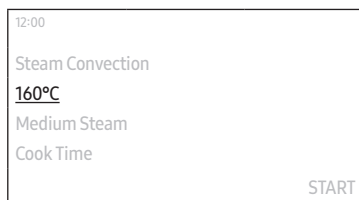

2. Set the desired temperature.
 - The default temperature and the temperature range differ depending on the cook mode.

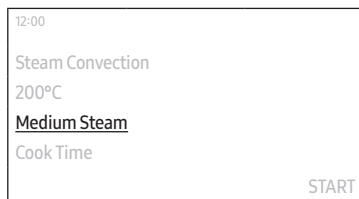

3. Set the steam level.
 - The default setting is “Medium”.

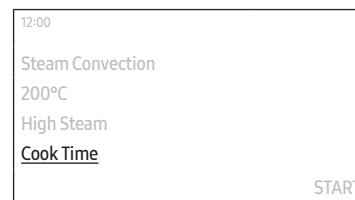

4. Tap **Cook Time** to set the desired cooking time.
 - Maximum cooking time is 10 hours.
5. After setting the cooking time, select the option you want to run at the end of cooking.
 - You can select **Oven Off**, **Keep Temp.**, or **Keep Warm**.

📖 NOTE

If you start cooking without setting the cooking time or set **Keep Temp.** for option, you must stop the oven manually.

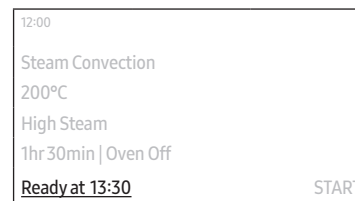

6. Tap **Ready at** to set the desired end time.
 - When you set the cooking time, the oven displays the time cooking will end. (Ex. **Ready at 13:30**)

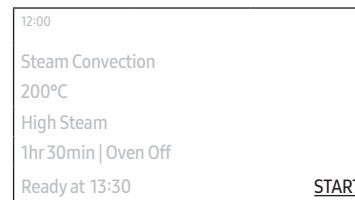

7. Tap **START**.
 - If you did not change the end time, the oven starts cooking immediately.
 - If you changed the end time, the oven will automatically adjust the start time to end cooking at the set time.

NOTE

- You can change the temperature and cooking time during cooking.
- During cooking, you can tap **Pause**, and then tap **OFF** to cancel cooking or tap **Continue** to keep cooking mode.
- When cooking is complete, **+5 mins** and **Add to Favourite** appears on the screen.
 - Tap **+5 mins** to extend the cooking for 5 more minutes.
 - Tap **Add to Favourite** to add the frequently used settings to the favourites list. You can easily apply the same settings next time you cook. (See "**Favourites**" section on page 20 for further information.)

Steam assisted mode descriptions

Mode	Temperature range (°C)	Default temperature (°C)
Steam Cook	-	-
	Hot steam from the steam generator is injected through several jet nozzles into the oven to cook food. This mode is suitable for cooking vegetables, fish, eggs, fruits, and rice.	
Steam Convection	100-230	160
	The heat generated by the convection heater and fans is continuously supported by hot steam. The intensity of the steam can be adjusted to Low, Medium, or High. This mode is suitable for baking puff pastries, yeast cake, bread, and pizza and roasting meat and fish.	
Steam Top Heat + Convection	100-230	180
	The heat generated by the top heater and the convection heater is shared evenly in the oven by the fan, and the hot steam supports the heating elements. This mode is suitable for roasting crusty dishes like meat, poultry, or fish.	
Steam Bottom Heat + Convection	100-230	200
	The heat generated by the bottom heating element and the convection heater is shared evenly in the oven by the fan, and the hot steam supports the heating elements. This mode is suitable for crispy baking foods like pizza or apple pie.	

NOTE

- Always fill the water reservoir with fresh water when cooking with these modes.
- After using the steam assisted modes, always wipe moisture inside the oven to prevent scale.

Operations

Special Function

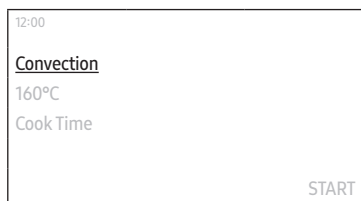

1. On the main screen, tap **Convection** and then **Special Function**.

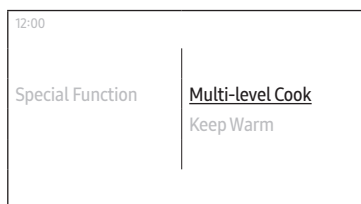

2. Select the desired function. (For detailed information of each function, see “**Special Function descriptions**” section on page 18.)



3. Set the desired temperature.

- The default temperature and the temperature differ depending on the cook mode.



4. Tap **Cook Time** to set the desired cooking time.

- Maximum cooking time is 10 hours.

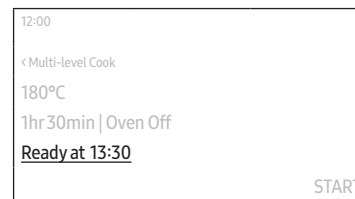

5. Tap **Ready at** to set the desired end time.

- When you set the cooking time, the oven displays the time the cooking will end. (Ex. **Ready at 13:30**)

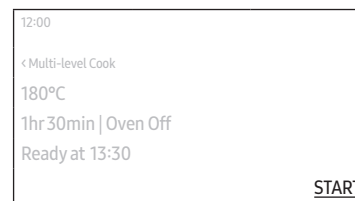

6. Tap **START**.

- If you did not change the end time, the oven starts cooking immediately.
- If you changed the end time, the oven will automatically adjust the start time to end cooking at the set time.

Special Function descriptions

Mode	Temperature range (°C)	Default temperature (°C)
Multi-level Cook	40-250	160
	Use this for cooking with two multi-levels at the same time.	
Keep Warm	60-100	60
	Use this only for keeping foods warm that has just been cooked.	

Auto Cook

The oven offers 35 Auto Cook programmes. Take advantage of this feature to save your time or shorten your learning curve. The cooking time and temperature will be adjusted according to the selected programme.

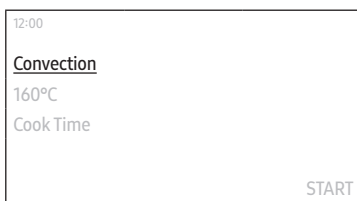

1. On the main screen, tap **Convection** and then **Auto Cook**.



2. Select the category.
3. Select the desired programme.
 - For detailed information of each programme, see “Auto Cook” in “Cooking Smart” section on page 26.)

4. Read the tip, and then tap **Next**.

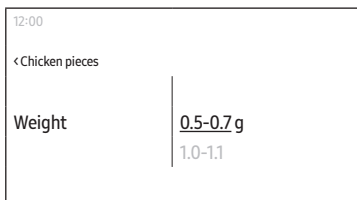

5. Select the weight.
 - This step may not apply to some programmes.
 - Available weight differs depending on the selected programme.

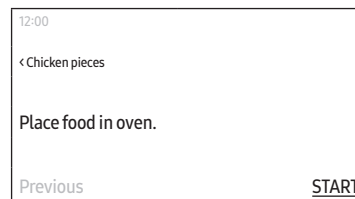

6. Pour the water in the water reservoir as instructed on the screen, and then tap **Next**.
 - This step may not apply to some programmes.
7. Prepare food and accessories as instructed on the screen, and then tap **Next**.
8. Tap **START**.

Operations

Auto Defrost

The oven offers 5 Auto Defrost programmes. Take advantage of this feature to conveniently defrost items. The cooking time, power level and temperature will be adjusted according to the selected programme.

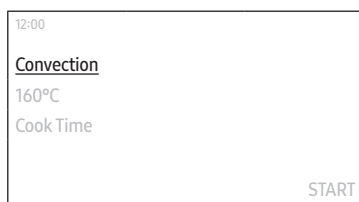

1. On the main screen, tap **Convection** and then **Auto Defrost**.



2. Select the desired programme.
 - For detailed information of each programme, see “Auto Defrost” in “Cooking Smart” section on page 30.)



3. Select the weight.
 - Available weight differs depending on the selected programme.
4. Prepare food and accessories as instructed on the screen, and then tap **Next**.

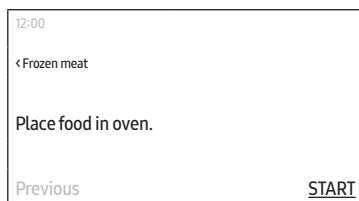

5. Tap **START**.

Favourites

You can add up to 10 frequently used cook settings to the Favourites list to easily apply them in the future.

Adding the new cook settings to the Favourites

1. Touch the  button on the control panel, and then tap **Favourites**.
2. On the Favourites screen, tap **+**.
3. Set the cook settings.
 - Items appear on the list may change upon what you select. (Cook mode, temperature, steam level, cook time, etc.)
4. Tap **Done**.
5. Enter the name using the keyboard, and then tap **OK**.



NOTE

Alternatively, you can simply tap **Add to Favourite** that appears when the oven completes cooking.

Editing the favourite cook settings

1. Touch the  button on the control panel, and then tap **Favourites**.
2. On the Favourites screen, tap the favourite cook setting you want to edit.
3. Tap **Edit**.
4. Change the cook settings.
 - Items appear on the list may change upon what you select. (Cook mode, temperature, cook time, etc.)
5. Tap **Done**.

Renaming the favourite cook settings

1. Touch the  button on the control panel, and then tap **Favourites**.
2. On the Favourites screen, tap .
3. Tap **Rename** on the right side of the favourite cook setting you want to rename.
4. Enter the name using the keyboard, and then tap **OK**.
5. Tap **Done**.

Deleting the favourite cook settings

1. Touch the  button on the control panel, and then tap **Favourites**.
2. On the Favourites screen, tap .
3. Tap **Delete** on the right side of the favourite cook setting you want to delete.

Using the favourite cook settings

1. Touch the  button on the control panel, and then tap **Favourites**.
2. Tap the favourite cook setting you want to use.
3. Tap **START**.

Timer

Adding the new Timer

1. Touch the  button on the control panel, and then tap **Timer**.
2. On the Timer screen tap **+**.

NOTE



If you are adding a timer for the first time, disregard this step.

3. Set the time.

Editing the existing Timer

1. Touch the  button on the control panel, and then tap **Timer**.
2. On the Timer screen, tap the timer you want to edit.
3. Change the time.



Renaming the Timer

1. Touch the  button on the control panel, and then tap **Timer**.
2. On the Timer screen, tap .
3. Tap **Rename** on the right side of the timer you want to rename.
4. Enter the name using the keyboard, and then tap **OK**.
5. Tap **Done**.



Operations

Deleting the Timer

1. Touch the  button on the control panel, and then tap **Timer**.
2. On the Timer screen, tap .
3. Tap **Delete** on the right side of the timer you want to delete.
4. Tap **Done**.

Using the Timer

1. Touch the  button on the control panel, and then tap **Timer**.
2. Tap **START** on the right side of the timer you want to use.

NOTE

When the time has elapsed to a set point, a message of “**Time is up.**” appears with a melody.

Tap **OK** to dismiss the message.

Cleaning

Steam Clean

This is useful for cleaning light soiling with steam.

This automatic function saves you time by removing the need for regular manual cleaning.

1. Touch the  button on the control panel, and then tap **Cleaning**.
2. Tap **Steam Clean**.
3. Follow the instruction on the screen, and then tap **Next**.
4. Tap **START**.

WARNING

Do not open the door before the cycle is complete. The water inside the oven is very hot, and it can cause burns.

NOTE

- If the oven is heavily soiled with grease, for example, after roasting or grilling, it is recommended to remove stubborn soil manually using a cleaning agent before activating Steam cleaning.
- Leave the oven door ajar when the cycle is complete. This is to allow the interior enamel surface to dry thoroughly.
- While the oven is hot inside, auto cleaning is not activated. Wait until the oven cools down and try again.
- Do not pour water onto the bottom by force. Do it gently. Otherwise, the water overflows to the front.



Descale

Clean inside the steam generator to prevent affecting the food quality and taste.

NOTE

- The oven counts the time of steam assisted modes and notifies you to run the Descale function when required. You can still use the steam assisted modes for the next two hours without running the Descale function. However, you cannot use the steam assisted modes after two hours unless you run and complete the Descale function.
 - When you get the notification message, tap **Start now** to run the Descale function or tap **Later** to postpone it.
1. Touch the  button on the control panel, and then tap **Cleaning**.
 2. Tap **Descale** and then **Next**.
 3. Follow the instruction on the screen, and then tap **START**.
 - If you get a notification message that you have insufficient water, add more water in the water reservoir and then tap **OK**.
 4. When descaling is complete, the oven drains water automatically.
 5. Once draining is complete, empty the water reservoir.
 6. Refill the water reservoir with 1000 ml of drinkable water as instructed on the screen, and then tap **OK** to start rinsing.
 7. When rinsing is complete, empty the water reservoir.
 - After emptying the reservoir, clean it before putting it back to the oven.

WARNING

- Wear oven gloves when you handle the water reservoir.
- Use only descaling agents that are specific to steam ovens or coffee machines.

CAUTION

- Do not cancel descaling in the process. Otherwise, you must restart the descaling cycle and complete within the next three hours in order to enable steam assisted modes.
- To avoid accidents, keep children away from the oven.
- For the mixture ratio of water and the descaling agent, follow the agent manufacturer's instruction as it precedes.

Drain

After using the steam assisted modes, you must drain the remaining water to prevent affecting other cooking modes. Also, if you want to drain again for cleaning purposes, use this function.

1. Touch the  button on the control panel, and then tap **Cleaning**.
2. Tap **Drain** and then **START**.
3. Follow the instruction on the screen, and then tap **OK**.
 - The oven drains water from the steam generator to the water reservoir.
4. When draining is complete, empty the water reservoir.
 - After emptying the reservoir, clean it before putting it back to the oven.

WARNING

Wear oven gloves when you handle the water reservoir.

NOTE

Once the oven starts draining, please wait until the draining cycle is complete.



Operations

Settings

Touch the  button on the control panel, and then tap **Settings** to change various settings for your oven.

Please refer to the following table for detailed descriptions.

Menu	Submenu	Description
Connections	Wi-Fi	You can turn the Wi-Fi on or off and connect to a Wi-Fi network.
	Easy Connection	You can connect the oven to the SmartThings server via a Wi-Fi connection. When the oven is connected, you can use the SmartThings app to check the status of the oven and/or control it from a mobile device.
	Remote management	Tap Activate to allow the Call Centre to access your oven remotely to check internal information.



Menu	Submenu	Description
Display	Brightness	You can change the brightness of the display screen.
	Screen saver	You can turn the screen saver on or off.  NOTE <ul style="list-style-type: none"> The Screen saver is a function that displays the date and time on your touch screen if there is no input for a certain time in standby status. Turn on Screen saver to activate Clock theme and Timeout.
	Clock theme	You can select the clock theme.
	Timeout	You can set the length of time before the screen saver turns on.  NOTE <ul style="list-style-type: none"> Energy consumption may increase depending on your setting. When the timeout setting is set to "Always on", the brightness of the LCD automatically changes to level 2 if there is no action for 3 minutes.

Menu	Submenu	Description
Date & time	Automatic date and time	You can turn on or turn off to update time from the Internet. You must be connected to the Wi-Fi network.
	Select time zone	You can select the time zone. (You must disable Automatic date and time.)
	Set date	You can manually set a date. (You must disable Automatic date and time.)
	Set time	You can manually set time. (You must disable Automatic date and time.)
	Select time format	You can select the time format from 12-hour or 24-hour format.
Language		You can select a language.
Volume		You can adjust the volume of the oven.
Water hardness		You can adjust the water hardness of the water you use for steam assisted modes. <ul style="list-style-type: none"> • Soft: Up to 120 ppm • Medium: 120-240 ppm • Medium-Hard: 240-350 ppm • Hard: Over 350 ppm
Help	Troubleshooting	You can check the troubleshooting.
	Guide for first use	You can check the simple instructions on basic use of the oven.

Menu	Submenu	Description
About device	Model name	You can check the model name of our oven.
	SW version	You can check the current version of the firmware. When you have new software available, SW update button will appear on this menu.
	Legal information	You can check the legal information.
Demo mode		You can turn the Demo mode on or off.

Lock

You can lock the control panel to prevent any unintended operation.

- To activate the Lock function, touch the  button on the control panel, and then tap **Lock**.
- To deactivate the Lock function, touch and hold the  button until you see the 'Control is unlocked.' message.

Cooking Smart

Auto Cook

The following table presents 35 Auto Programmes for Steam cooking, Baking, Grilling, Roasting and Reheat. The tables contains its quantities and appropriate recommendations.

Before using those programmes always fill water reservoir up to maximum level with fresh water. The other programmes are running with fan oven mode or grill mode. Use oven gloves while taking out!

1. Steaming

Food Item	Weight (kg)	Accessory	Shelf level
Broccoli florets	0.2-0.6	Steam dish, perforated	2
	Put broccoli florets on the steam dish and push the start to cook.		
Cauliflower florets	0.2-0.6	Steam dish, perforated	2
	Put cauliflower florets on the steam dish and push the start to cook.		
Steamed fish fillet, 2 cm	0.2-1.0	Steam dishes, perforated	2
	Put fish fillet (2 cm) on the steam dishes. Push the start to cook. You can use the baking tray on bottom for dripping.		
Steamed fish steak, 3 cm	0.2-1.0	Steam dishes, perforated	2
	Put fish steak (3 cm) on the steam dishes. Push the start to cook. You can use the baking tray on bottom for dripping.		

Food Item	Weight (kg)	Accessory	Shelf level
Steamed prawns	0.2-0.5	Steam dishes, perforated	2
	Put prawn (raw / uncooked-peeled or unpeeled) on the steam dishes. Push the start to cook. You can use the baking tray on bottom for dripping.		
Steamed chicken breast	0.2-1.0	Steam dishes, perforated	2
	Put chicken breast on the steam dishes and push the start to cook. You can use the baking tray on bottom for dripping.		
Egg, medium-boiled	0.1-0.6	Steam dish, perforated	2
	Put 2-10 eggs on the steam dish. If you like more firm eggs, leave the eggs to stand for a couple of minutes.		
Steamed potato half	0.4-0.8	Steam dish, perforated	2
	Cut potatoes (each 150-200 g) into halves and put on the steam dish and push the start to cook.		
White rice	0.2-0.4	Steam dish, perforated	2
	Distribute white rice (basmati or pandan) evenly in a flat pyrex dish. Add for each 100 g of rice, 200 ml cold water. Stir after steaming.		

Food Item	Weight (kg)	Accessory	Shelf level
Flan, steamed	0.4-0.6	Steam dish, perforated	2
	Put flan mixture in 6 small flan dishes (100 ml in each). Cover with cling film. Put dishes steam dish.		
Steeping dried fruit	0.1-0.5	Steam dish, perforated	2
	Put dried fruits (apricots, plums, apple) on the steam dish.		
Melting chocolate	0.1-0.3	Steam dish, perforated	2
	Break chocolate (pure or baking chocolate) into pieces, put in a small glass pyrex dish and cover with plastic foil or lid. Put dish on the steam dish. Keep covered during programme. After taking out stir well. (For white or milk chocolate decrease 5 min.)		

2. Baking

Food Item	Weight (kg)	Accessory	Shelf level
Apple pie	1.2-1.4	Oven rack	1
	Put apple pie into a round metal dish. Put on the oven rack. The weight ranges include apple and so on.		
Base for fruit pie	0.3-0.5	Oven rack	2
	Put batter into metal base dish on the oven rack.		
Brownies	0.5-0.7	Oven rack	2
	Put dough into a round glass pyrex or ceramic dish on the oven rack.		

Food Item	Weight (kg)	Accessory	Shelf level
Dutch butter pie	0.5-0.7	Oven rack	1
	Put batter into metal base dish on the oven rack.		
Dutch loaf cake	0.7-0.8	Oven rack	2
	Put fresh dough into suitable sized rectangular metal baking dish (length 25 cm). Put dish lengthway to the door on oven rack.		
Muffins	0.5-0.6	Oven rack	2
	Put muffin dough into metal muffin dish, suitable for 12 muffins. Set dish in the middle of oven rack.		
Sponge cake	0.3-0.6	Oven rack	1
	Put 300 g dough into 18 cm, 400 g into 24 cm and 500 g into 26 cm diameter round black metal baking dish. Set dish in the middle of oven rack.		
Homemade pizza	0.6-1.0	Baking tray	1
	Put pizza on the baking tray. The weight ranges include topping such as sauce, vegetables, ham and cheese.		

Cooking Smart

3. Grilling

Food Item	Weight (kg)	Accessory	Shelf level
Beef steak, thin	0.3-0.6	Oven rack / Baking tray	4 / 1
	Put beef steaks side by side in the middle of oven rack and baking tray. Turn the food over when the notification pops up, and then tap OK . Then, tap Continue to resume process.		
Chicken pieces	0.5-0.7 1.0-1.2	Oven rack / Baking tray	4 / 1
	Brush chilled chicken pieces with oil and spices. Put skin-side down on oven rack and baking tray. Turn the food over when the notification pops up, and then tap OK . Then, tap Continue to resume process.		
Chicken drumsticks	0.5-0.7	Oven rack / Baking tray	4 / 1
	Put the marinated chicken drumsticks side by side on the oven rack and baking tray. Turn the food over when the notification pops up, and then tap OK . Then, tap Continue to resume process.		
Grilled fish steak	0.3-0.6	Oven rack / Baking tray	4 / 1
	Marinate fish fillet (1 cm) and put side by side on oven rack and baking tray. Turn the food over when the notification pops up, and then tap OK . Then, tap Continue to resume process.		

Food Item	Weight (kg)	Accessory	Shelf level
Grilled fish fillet	0.3-0.6	Oven rack / Baking tray	4 / 1
	Marinate fish fillet (1 cm) and put side by side on oven rack and baking tray. Turn the food over when the notification pops up, and then tap OK . Then, tap Continue to resume process.		
Lamb chops	0.3-0.6	Oven rack / Baking tray	4 / 1
	Marinate lamb chops. Put lamb chops on oven rack and baking tray. Turn the food over when the notification pops up, and then tap OK . Then, tap Continue to resume process.		

4. Roasting

Food Item	Weight (kg)	Accessory	Shelf level
Whole chicken	1.0-1.1 1.2-1.3	Oven rack / Baking tray	2 / 1
	Brush chilled chicken with oil and spices. Put breast-side-down, in the middle of oven rack and baking tray. Turn the food over when the notification pops up, and then tap OK . Then, tap Continue to resume process.		
Roast beef, medium rare	1.1-1.3	Oven rack / Baking tray	2 / 1
	Brush the beef with oil and spices (pepper only, salt should be added after roasting). Put it on the oven rack and baking tray, with the fat-side down. Turn the food over when the notification pops up, and then tap OK . Then, tap Continue to resume process. After roasting and during standing time of 5-10 minutes it should be wrapped in aluminium foil.		
Roast pork	0.7-0.9	Oven rack / Baking tray	2 / 1
	Put pork roast, brushed with oil and spices, with the fat-side down on the oven rack and baking tray. Turn the food over when the notification pops up, and then tap OK . Then, tap Continue to resume process.		

Food Item	Weight (kg)	Accessory	Shelf level
Whole fish	0.4-0.8	Oven rack / Baking tray	2 / 1
	Brush skin of whole fish with oil and herbs and spices. Put fish side by side, head to tail on the oven rack and baking tray. Turn the food over when the notification pops up, and then tap OK . Then, tap Continue to resume process. The programme is suitable for whole fishes, like trout, pikeperch or gilthead.		
Roasted vegetables	0.2-0.5	Baking tray	4
	Put vegetables, such as sliced courgette, pieces of pepper, sliced aubergine, mushrooms and cherry tomatoes into baking tray. Brush with a mixture of olive oil, herbs and spices.		
Baked potato	0.4-0.8	Baking tray	2
	Use middle sized potatoes. Rinse and clean potatoes. Brush skin with a mixture of olive oil, salt pepper and herbs. Put potatoes side by side on baking tray.		

Cooking Smart

5. Auto Reheat

Food Item	Weight (kg)	Accessory	Shelf level
Frozen pizza	0.3-0.4 0.4-0.5	Oven rack	2
	Put frozen pizza in the middle of oven rack.		
Frozen oven chips	0.4-0.5	Baking tray	2
	Distribute frozen oven chips on baking tray.		
Frozen fish fingers	0.3-0.5	Baking tray	2
	Put frozen fish finger evenly on baking tray. If turnover when beeps, you can get the better results.		

Auto Defrost

Food Item	Weight (kg)	Standing time (min.)	Shelf level
Frozen meat (-18 °C)	0.2-0.5 0.8-1.5	10-30	Always shield the edges with aluminium foil. This programme is suitable for beef, lamb, pork, steaks, chops, minced meat. Put the meat on the oven rack. Insert oven rack in shelf level 2, baking tray in shelf level 1.
Frozen poultry (-18 °C)	0.3-0.6 0.9-1.3	10-30	Always shield the leg and wing tips with aluminium foil. This programme is suitable for whole chicken as well as for chicken portions. Put poultry on the oven rack. Insert oven rack in shelf level 2, baking tray in shelf level 1.
Frozen fish (-18 °C)	0.3-0.8	10-30	Always shield the tail of a whole fish with aluminium foil. This programme is suitable for whole fishes as well as for fish fillets. Put fish on the oven rack. Insert oven rack in shelf level 2, baking tray in shelf level 1.

Food Item	Weight (kg)	Standing time (min.)	Shelf level
Frozen bread (-18 °C)	0.1-0.3 0.4-0.6	5-10	Put bread horizontally, lengthways to the door on the baking tray, shelf level 2. This programme is suitable for all kinds of sliced bread, as well as for bread rolls and baguettes.
Frozen fruit (-18 °C)	0.2-0.6	5-10	Distribute fruits evenly into baking tray, shelf level 2. This programme is suitable for all kinds of sliced fruits or berries.

CAUTION

- After defrosting meat (particularly poultry), operate the empty oven about 10 minutes in the Convection mode (200 °C) for killing bacteria in the cavity.
- Do not refreeze food once it has thawed.

NOTE

1. When you have finished defrosting, pour out the water in the tray and wash out the tank.
2. Dry the cooking room with a dry cloth if there is any remaining water.
3. The cooling fan always works for 3-10 minutes after Auto Defrost mode. However, this is not a malfunction and you do not need to worry about this.

Manual cooking

Steam assisted mode

Steam Cook

Use settings and times in this table as guide lines for steaming.

We recommend to always fill the water reservoir with fresh water to the maximum level.

Sometimes you can use the baking tray on bottom for collecting condensation, for example fish fillet.

Food Item	Time (min.)	Accessory (shelf level)
Broccoli florets	12-14	Steam dish, perforated (2)
Whole carrots	25-30	Steam dish, perforated (2)
Sliced vegetables (pepper, courgettes, carrots, onions)	15-20	Steam dish, perforated (2)
Green beans	20-25	Steam dish, perforated (2)
Asparagus	10-15	Steam dish, perforated (2)
Whole vegetables (artichokes, whole cauliflower, corn on the cob)	25-35	Steam dish, perforated (2)
Peeled potatoes (cut into quarters)	30-35	Steam dish, perforated (2)
Fish fillet (2 cm thickness)	15-20	Steam dish, perforated (2)
Prawns (raw/uncooked)	10-14	Steam dish, perforated (2)
Chicken breast	23-28	Steam dish, perforated (2)

Cooking Smart

Food Item	Time (min.)	Accessory (shelf level)
Boiled eggs (hardboiled)	16-20	Steam dish, perforated (2)
Frozen yeast dumplings	25-30	Steam dish, perforated (2)
White rice (basmati or pandan) (Use a flat pyrex dish, add double quantity of water)	30-35	Steam dish, perforated (2)
Milk rice (Use a flat pyrex dish, add double or four times quantity of milk)	40-50	Steam dish, perforated (2)
Fruit compote (Use a flat round glass pyrex, add 1 teaspoon sugar and 2 tbsp. water)	25-35	Steam dish, perforated (2)
Flan/Crème (6 dessert dishes, each 100 ml, cover dishes with foil)	20-25	Steam dish, perforated (2)
Egg custard (Use a large flat glass pyrex dish, cover dish with foil)	30-35	Steam dish, perforated (2)

Two level steam cooking

Use settings and times in this table as guide lines for steam cooking.

We recommend to always fill the water reservoir with fresh water to the maximum level. If you have different food with a similar preparation time, you can put all the items in the oven at the same time. Otherwise put in first the item with the longest preparation time.

Put steam dish on level 2 and the oven rack on level 4.

Food Item	Time (min.)	Accessory (shelf level)
2-level cooking: Dual Meals (fish fillets/sliced vegetables)	15-20	Oven rack (4) / Steam dish, perforated (2)
2-level cooking: Dual Meals (chicken breasts/whole vegetables)	25-30	Oven rack (4) / Steam dish, perforated (2)

We recommend to use a flat pyrex dish on oven rack.

Please increase the cooking time by 20-30 % than a kind of food if you want to cook many different foods at the same time.

Steam Convection / Steam Top Heat + Convection / Steam Bottom Heat + Convection

Use settings and times in this table as guide lines for baking and roasting.

We recommend to always fill the water reservoir with fresh water to the maximum level.

Food item	Combi. Steam mode	Temp. (°C)	Preheat	Steam level	Time (min.)	Accessory (shelf level)
Puff pastry stripes (add grated cheese)	Steam Convection	200	0	Low	15-20	Baking tray (1)
Croissants (all ready made croissant dough)	Steam Convection	180	0	Low	20-25	Baking tray (1)
Homemade bread	Steam Bottom Heat + Convection	180	0	Mid	30-40	Oven rack (1)
Vegetable gratin / Potato gratin	Steam Convection	160-180	0	Mid	35-50	Oven rack (2)
Roast beef, 1 kg Medium-welldone	Steam Top Heat + Convection	1 st stage : 180 2 nd stage : 180	X	High	1 st stage : 25-35 2 nd stage : 25-35	Oven rack (2) / Baking tray (1)
Whole chicken	Steam Top Heat + Convection	1 st stage : 210 2 nd stage : 210	X	High	1 st stage : 30-40 2 nd stage : 20-30	Oven rack (2) / Baking tray (1)
Chicken pieces	Steam Top Heat + Convection	1 st stage : 210 2 nd stage : 210	X	High	1 st stage : 20-30 2 nd stage : 20-30	Oven rack (2) / Baking tray (1)

NOTE

- We recommend turning the food over 1st and 2nd stage.
- If you open the door while oven is cooking, the oven stops. To restart the oven, close the door and tap **START**.

Convection guide

Convection

Use temperatures and times in this table as guidelines for baking.

We recommend to preheat the oven with Convection mode.

Food Item	Temp. (°C)	Time (min.)	Accessory (shelf level)
Hazelnut cake square mould	160-170	60-70	Oven rack (1)
Lemon cake ring-shaped or bowl mould	150-160	50-60	Oven rack (1)
Sponge cake	150-160	25-35	Oven rack (1)
Fruit flan base	150-170	25-35	Oven rack (1)
Flat streusel fruit cake (yeast dough)	150-170	30-40	Baking tray (2)
Croissants	170-180	10-15	Baking tray (1)
Bread rolls	180-190	10-15	Baking tray (1)
Cookies	160-180	10-20	Baking tray (2)
Oven chips	200-220	15-20	Baking tray (2)

Cooking Smart

Top Heat + Convection

Use temperatures and times in this table as guidelines for roasting.

We recommend to preheat the oven using Top Heat + Convection mode.

Put meat on oven rack, follow shelf level advice in the table and use baking tray as oil pan on level 1.

Food Item	Temp. (°C)	Time (min.)	Accessory (shelf level)
Roast beef (1 kg / medium)	170-190	60-90	Oven rack (2) / Baking tray (1)
Pork shoulder joint / Roll (1 kg)	180-200	90-120	Oven rack (2) / Baking tray (1)
Roast lamb / Leg of lamb (0.8 kg)	190-210	50-80	Oven rack (2) / Baking tray (1)
Whole chicken (1.2 kg)	200-220	50-70	Oven rack (2) / Baking tray (1)
Fish whole trouts (2 pcs. / 0.5 kg)	180-200	30-40	Oven rack (2) / Baking tray (1)
Duck breast (0.3 kg)	180-200	25-35	Oven rack (2) / Baking tray (1)

Bottom Heat + Convection

Use temperatures and times in this table as guidelines for baking and roasting.

We recommend to preheat the oven with Bottom Heat + Convection mode.

Food Item	Temp. (°C)	Time (min.)	Accessory (shelf level)
Homemade pizza	180-200	20-30	Baking tray (1)
Chilled pre-baked quiche / Pie	180-200	10-15	Oven rack (1)
Frozen self rising pizza	180-200	15-20	Baking tray (1)
Frozen pizza	180-200	15-25	Baking tray (1)
Chilled pizza	180-200	8-15	Baking tray (1)
Apple pie	160-180	60-70	Oven rack (1)
Puff pastry, apple filling	180-200	10-15	Baking tray (1)

Grilling guide

Large Grill

Use temperatures and times in this table as guidelines for grilling.
Set 220 °C grill temperature, preheat for 5 minutes.

Food Item	1 st Time (min.)	2 nd Time (min.)	Accessory (shelf level)
Kebab spits	8-10	6-8	Oven rack (4) / Baking tray (1)
Pork steaks	7-9	5-7	Oven rack (4) / Baking tray (1)
Sausages	6-8	6-8	Oven rack (4) / Baking tray (1)
Chicken pieces	20-25	15-20	Oven rack (4) / Baking tray (1)
Salmon steaks	8-12	6-10	Oven rack (4) / Baking tray (1)
Sliced vegetables	15-20	-	Baking tray (4)
Toast	2-3	1-2	Oven rack (4)
Cheese toasts	3-5	-	Oven rack (4)

Fan Grill

Use temperatures and times in this table as guidelines for grilling.
Set 220 °C grill temperature, preheat for 5 minutes.

Food Item	Time (min.)	Accessory (shelf level)
Sausages	8-10	Oven rack (3)
Potato wedges	20-25	Oven rack (3)
Frozen oven chips	15-20	Baking tray (3)
Frozen croquettes	20-25	Baking tray (3)
Frozen nuggets	15-20	Baking tray (3)
Salmon steak	15-20	Oven rack (3) / Baking tray (1)
Fish fillet	12-17	Oven rack (3) / Baking tray (1)
Whole fish	15-20	Oven rack (3) / Baking tray (1)
Chicken pieces	30-40	Oven rack (3) / Baking tray (1)

Cooking Smart

Fan Conventional guide

Use temperatures and times in this table as guidelines for baking and roasting. We recommend to preheat the oven with Fan Conventional mode.

Food Item	Temp. (°C)	Time (min.)	Accessory (shelf level)
Lasagne	200-220	20-25	Oven rack (2)
Vegetables gratin	180-200	20-30	Oven rack (2)
Potato gratin	180-200	40-60	Oven rack (2)
Frozen pizza baguettes	160-180	10-15	Baking tray (2)
Marble cake	160-180	50-70	Oven rack (1)
Loaf cake	150-170	50-60	Oven rack (1)
Muffins	180-200	20-30	Oven rack (1)
Cookies	180-200	10-20	Baking tray (2)

Intensive Cook guide

Use temperatures and times in this table as guidelines for roasting. We recommend to preheat the oven with Intensive (Top + Bottom + Convection) mode.

Food Item	Temp. (°C)	Time (min.)	Accessory (shelf level)
Lasagne (2 kg)	180-200	20-30	Oven rack (1)
Vegetables gratin (2 kg)	160-180	40-60	Oven rack (1)
Potato gratin (2 kg)	160-180	60-90	Oven rack (1)
Roast beef (2 kg / medium)	160-180	60-90	Oven rack (2) / Baking tray (1)
Whole duck (2 kg)	180-200	60-90	Oven rack (2) / Baking tray (1)
2 Whole chickens (1.2 kg each)	200-220	60-90	Oven rack (2) / Baking tray (1)

Pro-Roasting

This mode includes an automatic heating-up cycle over 200 °C. The top heater and the convection fan is operating during the process of searing the meat. After this stage the food is cooked gently by the low temperature of pre-selection.

This process is done while the top and the bottom heaters are operating.

This mode is suitable for meat roasts, poultry and fish.

Use temperatures and times in this table as guidelines for roasting.

Food Item	Temp. (°C)	Time (hrs.)	Accessory (shelf level)
Roast beef	80-100	3:30-4:30	Oven rack (2) / Baking tray (1)
Roast pork	90-110	3:30-4:00	Oven rack (2) / Baking tray (1)
Duck breast	80-100	1:30-2:00	Oven rack (2) / Baking tray (1)
Fillet of beef	80-100	1:30-2:00	Oven rack (2) / Baking tray (1)
Pork fillet	80-100	1:30-2:00	Oven rack (2) / Baking tray (1)

Eco Convection

This mode uses the optimized heating system so that you save the energy during cooking your dishes. The times of this category are suggested to not be preheated before cooking for saving more energy.

Food	Accessory	Level	Temp. (°C)	Time (min.)
Fruit crumble, 0.8-1.2 kg	Oven rack	1	160-180	50-70
Jacket potatoes, 0.4-0.8 kg	Baking tray	2	190-200	60-70
Sausages, 0.3-0.5 kg	Oven rack + Baking tray	2 1	160-180	20-30
Frozen oven chips, 0.3-0.5 kg	Baking tray	2	180-200	30-40
Frozen potato wedges, 0.3-0.5 kg	Baking tray	2	190-210	30-40
Fish fillets, baked, 0.4-0.8 kg	Oven rack + Baking tray	2 1	200-220	25-35
Crispy fish fillets, breaded, 0.4-0.8 kg	Oven rack + Baking tray	2 1	200-220	30-40
Roast sirloin of beef, 0.8-1.2 kg	Oven rack + Baking tray	2 1	180-200	60-70
Roast vegetables, 0.4-0.6 kg	Baking tray	2	200-220	20-30

Energy saving tip

- If cooking time is more than 30 minutes, you can switch off the oven 5-10 minutes before the end of the cooking time for energy saving. The residual heat will complete the cooking process.
- Please do not open the door frequently during cooking to keep the temperature in cavity and it will save the energy and time.

Multi-level Cook (Special)

Use temperatures and times in this table as guidelines for baking. We recommend to preheat the oven with Multi-level Cook mode.

Food Item	Temp. (°C)	Time (min.)	Accessory (shelf level)
Small cakes	150-160	20-30	2 baking trays (4+2)
Mini pies	160-180	20-30	2 baking trays (4+2)
Croissants	160-180	20-30	2 baking trays (4+2)
Puff pastry	180-200	30-40	2 baking trays (4+2)
Cookies	170-190	15-20	2 baking trays (4+2)
Lasagne	160-180	30-45	Oven rack (4) / Baking Tray (2)
Frozen oven chips	180-200	30-50	2 baking trays (4+2)
Frozen nuggets	180-200	20-30	2 baking trays (4+2)
Frozen pizza	200-220	20-30	Oven rack (4) / Baking Tray (2)

Cooking Smart

Test dishes

According to standard EN 60350

1. Baking

The recommendations for baking refer to preheated oven. Insert baking tray with slanted side towards the door front.

Type of food	Dish & Notes	Shelf level	Cooking mode	Temp. (°C)	Cooking time (min.)
Small cakes	Baking tray	1	Fan conventional	150-160	20-30
		1	Convection	150-160	20-25
	Baking tray + Baking tray	2 + 4	Multi-Level Cook	150-160	20-30
Fatless sponge cake	Springform cake tin on Big grid (Dark coated, Ø 26 cm)	1	Conventional	150-160	20-30
		1	Convection	150-160	30-35
Shortbread	Baking tray	1	Conventional	150-160	20-30
		1	Convection	150-160	20-30
Apple yeast tray cake	Baking tray	1	Conventional	150-160	40-50
		1	Convection	150-160	45-55
Apple pie	Big grid + 2 Springform cake tins * (Dark coated, Ø 20 cm)	1 Placed diagonally	Bottom Heat + Convection	170-190	70-90

* Two cakes are arranged on the grid at the back left and at the front right.

2. Grilling

Preheat the empty oven for 5 minutes using Grill function.

Type of food	Dish & Notes	Shelf level	Cooking mode	Temp. (°C)	Cooking time (min.)
White bread toasts	Oven rack	4	Grill	250	1 st 1-2 2 nd 1-2
Beef burgers (12 ea)	Oven rack + Baking tray (to catch drippings)	4+2	Grill	250	1 st 10-15 2 nd 10-15

Maintenance

Cleaning

Clean the oven regularly to prevent impurities from building up on or inside the oven. Also pay special attention to the door and the door sealing (applicable models only).

If the door won't open or close smoothly, first check if the door seals have built up impurities. Use a soft cloth in soapy water to clean both the inner and outer sides of the oven. Rinse and dry well.

If there are fingerprints, grease, or stains on the exterior (such as the door surface, handle, or display), clean with a soft cloth with a glass cleaner or neutral detergent, and then wipe dry with a soft, clean, dry cloth.

To remove stubborn impurities with bad smells from inside the oven

1. With an empty oven, put a cup of diluted lemon juice on the centre of the cavity.
2. Heat the oven for 10 minutes at max temperature of the oven mode.
3. When the cycle is complete, wait until the oven cools down. Then, open the door and clean the cooking chamber.

⚠ CAUTION

- Keep the door and door sealing clean and ensure the door opens and closes smoothly. Otherwise, the oven's lifecycle may be shortened.
- Take caution not to spill water into the oven vents.
- Do not use any abrasive or chemical substances for cleaning.
- After each use of the oven, use a mild detergent to clean the cooking chamber after waiting for the oven to cool down.

Side racks (applicable models only)

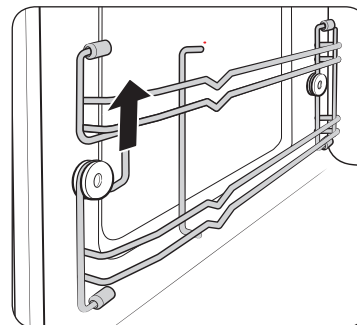

1. Lift up the front of the rack to release it from the holder.

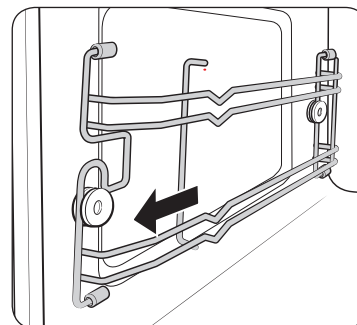

2. Pull the rack forward to remove it.
3. Remove the other side rack in the same way.
4. Clean both side racks.
5. When done, follow steps 1 to 2 in reverse order to assemble them.

📄 NOTE

The oven operates without the side racks and racks in position.

Maintenance

Replacement (repair)

⚠ WARNING

This oven has no user-removable parts inside. Do not try to replace or repair the oven yourself.

- If you encounter a problem with hinges, sealing, and/or the door, contact a qualified technician or a local Samsung service centre for technical assistance.
- If you want to replace the light bulb, contact a local Samsung service centre. Do not replace it yourself.
- If you encounter a problem with the outer housing of the oven, first unplug the power cord from the power source, and then contact a local Samsung service centre.

Care against an extended period of disuse

If you don't use the oven for an extended period of time, unplug the power cord and move the oven to a dry, dust-free location. Dust and moisture that builds up inside the oven may affect the performance of the oven.

Troubleshooting

You may encounter a problem using the oven. In that case, first check the table below and try the suggestions. If a problem persists, or if any information code keeps appearing on the display, contact a local Samsung service centre.

Checkpoints

If you encounter a problem with the oven, first check the table below and try the suggestions.

Problem	Cause	Action
General		
The buttons cannot be pressed properly.	Foreign matter may be caught between the buttons.	Remove the foreign matter and try again.
	For touch models: Moisture is on the exterior.	Wipe the moisture from the exterior.
	Child lock is activated.	Deactivate Child lock.
The time is not displayed.	Power is not supplied.	Make sure power is supplied.
	The display option is off.	Turn the display option on. It is normal for the current time to disappear a few minutes after the display option has been turned on.

Problem	Cause	Action
The oven does not work.	Power is not supplied.	Make sure power is supplied.
	The door is open.	Close the door and try again.
	The door open safety mechanisms are covered in foreign matter.	Remove the foreign matter and try again.
The oven stops while in operation.	The user has opened the door to turn food over.	After turning the food over, tap Continue to resume process.
The power turns off during operation.	The oven has been cooking for an extended period of time.	After cooking for an extended period of time, let the oven cool.
	The cooling fan is not working.	Listen for the sound of the cooling fan.
	Trying to operate the oven without food inside.	Put food in the oven.
	There is not sufficient ventilation space for the oven.	There are intake/exhaust outlets on the front and rear of the oven for ventilation. Keep the gaps specified in the product installation guide.
	Several power plugs are being used in the same socket.	Designate only one socket to be used for the oven.

Problem	Cause	Action
There is no power to the oven.	Power is not supplied.	Make sure power is supplied.
There is a popping sound during operation, and the oven doesn't work.	Cooking sealed food or using a container with a lid may causes popping sounds.	Do not use sealed containers as they may burst during cooking due to expansion of the contents.
The oven exterior is too hot during operation.	There is not sufficient ventilation space for the oven.	There are intake/exhaust outlets on the front and rear of the oven for ventilation. Keep the gaps specified in the product installation guide.
	Objects are on top of the oven.	Remove all objects on the top of the oven.
The door cannot be opened properly.	Food residue is stuck between the door and oven interior.	Clean the oven and then open the door.
The interior light is dim or does not turn on.	The door has been left open for a long time.	The interior light may automatically turn off when the door stays open for a long time. Close and reopen the door or press the Cancel button.
	The interior light is covered by foreign matter.	Clean the inside of the oven and check again.

Troubleshooting

Problem	Cause	Action
A beeping sound occurs during cooking.	If the Auto Cook function is being used, this beeping sound means it's time to turn over the food during thawing.	Turn the food over when the notification pops up, and then tap OK . Then, tap Continue to resume process.
The oven is not level.	The oven is installed on an uneven surface.	Make sure the oven is installed on flat, stable surface.
There are sparks during cooking.	Metal containers are used during the oven/thawing functions.	Do not use metal containers.
When power is connected, the oven immediately starts to work.	The door is not properly closed.	Close the door and check again.
There is electricity coming from the oven.	The power or power socket is not properly grounded.	Make sure the power and power socket are properly grounded.
There is water dripping.	There may be water or steam in some cases depending on the food. This is not an oven malfunction.	Let the oven cool and then wipe with a dry dish towel.
Steam leaks from the door.	There may be water or steam in some cases depending on the food. This is not an oven malfunction.	Let the oven cool and then wipe with a dry dish towel.

Problem	Cause	Action
There is water left in the oven.	There may be water or steam in some cases depending on the food. This is not an oven malfunction.	Let the oven cool and then wipe with a dry dish towel.
The brightness inside the oven varies.	Brightness changes depending on power output changes according to function.	Power output changes during cooking are not malfunctions. This is not an oven malfunction.
Cooking is finished, but the cooling fan is still running.	To ventilate the oven, the cooling fan continues to run for about 5 minutes after cooking is complete.	This is not an oven malfunction.

Problem	Cause	Action
Grill		
Smoke comes out during operation.	During initial operation, smoke may come from the heating elements when you first use the oven.	This is not a malfunction, and if you run the oven 2-3 times, it should stop.
	Food is on the heating elements.	Let the oven cool and then remove the food from the heating elements.
	Food is too close to the grill.	Put the food a suitable distance away while cooking.
	Food is not properly prepared and/or arranged.	Make sure food is properly prepared and arranged.

Problem	Cause	Action
Oven		
The oven does not heat.	The door is open.	Close the door and try again.
Smoke comes out during preheating.	During initial operation, smoke may come from the heating elements when you first use the oven.	This is not a malfunction, and if you run the oven 2-3 times, it should stop.
	Food is on the heating elements.	Let the oven cool and then remove the food from the heating elements.
There is a burning or plastic smell when using the oven.	Plastic or non heat-resistant cookware is used.	Use glass cookware suitable for high temperatures.
There is a bad smell coming from inside the oven.	Food residue or plastic has melted and stuck to the interior.	Use the steam function and then wipe with a dry cloth. You can put a lemon slice inside and run the oven to remove the odour more quickly.

Troubleshooting

Problem	Cause	Action
The oven does not cook properly.	The oven door is frequently opened during cooking.	Do not frequently open the door unless you are cooking things that need to be turned. If you open the door often, the interior temperature will be lowered and this may affect the results of your cooking.
	The oven controls are not correctly set.	Correctly set the oven controls and try again.
	The grill or other accessories are not correctly inserted.	Correctly insert the accessories.
	The wrong type or size of cookware is used.	Reset the oven controls or use suitable cookware with flat bottoms.

Information codes

If the oven fails to operate, you may see an information code on the display. Check the table below and try the suggestions.

Code	Description	Action
C-20	The temperature sensor is open.	Unplug the power cord of the oven, and contact a local Samsung service centre.
	The temperature sensor is short.	
C-70	The steam sensor is open.	
	The steam sensor is short.	
C-F0	If there is no communication between the main and sub MICOM.	
C-F1	Only occurs when EEPROM Read or Write is not working.	
C-21	This code appears when the oven temperature high. In case the temperature rises over the limit temperature during operation of each mode. (Fire sensed.)	Unplug the power cord for cooling enough time, and restart the oven.
C-F2		Stop the oven and then try again.
C-d0	The touch key is malfunction.	Unplug the power cord for cooling enough time, and clean the button. (Dust, Water) When appear same problem, contact a local Samsung service centre.

Technical specifications

SAMSUNG strives to improve its products at all times. Both the design specifications and these user instructions are thus subject to change without notice.

Power Source		230 V ~ 50 Hz
Power Consumption	Maximum power	2850 W
	Grill	2550 W
	Convection	2500 W
	Steam	2850 W
Cooling Method		Cooling fan motor
Dimensions (W x H x D)	Main unit	595 X 456 X 570 mm
	Built-in	560 X 446 X 549 mm
Volume		50 liter
Weight	Net	36.1 Kg
	Shipping	40.4 Kg

Appendix

Product data sheet

SAMSUNG		SAMSUNG
Model identification		NQ50T9939BD
Energy Efficiency Index per cavity (EEI _{cavity})		80.3
Energy Efficiency Class per cavity		A+
Energy consumption (electricity) required to heat a standardised load in a cavity of an electric heated oven during a cycle in conventional mode per cavity (electric final energy) (EC _{electric cavity})		-
Energy consumption required to heat a standardised load in a cavity of an electric heated oven during a cycle in fan-forced mode per cavity (electric final energy) (EC _{electric cavity})		0.61kWh/cycle
Number of cavities		1
Heat source per cavity (electricity or gas)		electricity
Volume per cavity (V)		50 L
Type of oven		Built-in
Mass of the appliance (M)		36.3 Kg
WiFi	Standby-mode Power Consumption (W)	1.9 W
	Period of time for the power management (min)	20 min.
Off mode	Power consumption	0.5 W
	Period of time for the power management (min)	10 min.

Data determined according to standard EN 60350-1, EN 50564, Commission Regulations (EU) No 65/2014 and (EU) No 66/2014, and Regulation (EC) No 1275/2008.

Appendix

Energy saving tips

- During cooking, the oven door should remain closed except for turning food over.
Do not open the door frequently during cooking to maintain the oven temperature and to save energy.
- If cooking time is more than 30 minutes, the oven may be switched off 5-10 minutes before the end of the cooking time to save energy. The residual heat will complete the cooking process.
- Plan oven use to avoid turning the oven off between cooking one item and the next to save energy and reduce the time for re-heating the oven.
- Wherever possible cook more than one item at a time.

Open Source Announcement

The software included in this product contains open source software. You may obtain the complete corresponding source code for a period of three years after the last shipment of this product by sending an email to <mailto:oss.request@samsung.com>.

It is also possible to obtain the complete corresponding source code in a physical medium such as a CD-ROM; a minimal charge will be required.

The following URL http://opensource.samsung.com/opensource/OVEN_R18_TZ4/seq/0 leads to the download page of the source code made available and open source license information as related to this product. This offer is valid to anyone in receipt of this information.



Memo

Please be advised that the Samsung warranty does NOT cover service calls to explain product operation, correct improper installation, or perform normal cleaning or maintenance.

QUESTIONS OR COMMENTS?

COUNTRY	CALL	OR VISIT US ONLINE AT
AUSTRIA	0800 72 67 864 (0800-SAMSUNG)	www.samsung.com/at/support
BELGIUM	02-201-24-18	www.samsung.com/be/support (Dutch) www.samsung.com/be_fr/support (French)
DENMARK	707 019 70	www.samsung.com/dk/support
FINLAND	030-6227 515	www.samsung.com/fi/support
FRANCE	01 48 63 00 00	www.samsung.com/fr/support
GERMANY	06196 77 555 77	www.samsung.com/de/support
ITALIA	800-SAMSUNG (800.7267864)	www.samsung.com/it/support
CYPRUS	8009 4000 only from landline, toll free	www.samsung.com/gr/support
GREECE	80111-SAMSUNG (80111 726 7864) only from land line (+30) 210 6897691 from mobile and land line	www.samsung.com/gr/support
LUXEMBURG	261 03 710	www.samsung.com/be_fr/support
NETHERLANDS	088 90 90 100	www.samsung.com/nl/support
NORWAY	21629099	www.samsung.com/no/support
PORTUGAL	808 207 267	www.samsung.com/pt/support
SPAIN	91 175 00 15	www.samsung.com/es/support
SWEDEN	0771 726 786	www.samsung.com/se/support
SWITZERLAND	0800 726 786 (0800-SAMSUNG)	www.samsung.com/ch/support (German) www.samsung.com/ch_fr/support (French)
UK	0330 SAMSUNG (7267864)	www.samsung.com/uk/support
IRELAND (EIRE)	0818 717100	www.samsung.com/ie/support



DG68-01194F-00