

Microwave oven

User manual

NQ5B4553F**

SAMSUNG



Contents

Safety instructions	3
Important safety instructions	3
General safety	7
Microwave operation precautions	8
Limited warranty	9
Product group definition	9
Correct Disposal of This Product (Waste Electrical & Electronic Equipment)	9
Installation	10
What's included	10
Installation instructions	11
Maintenance	14
Cleaning	14
Replacement (repair)	14
Care against an extended period of disuse	14
Before you start	15
Control panel	15
Clock	15
Side racks	16
About microwave energy	16
Cookware for microwave	17
Operations	18
Feature overview	18
Manual mode	19
Auto mode	23
Auto cook guide	24

Special functions	27
More Functions	29
Smart Control	30
Cooking Smart	31
Manual cooking	31
Quick & Easy	38
Troubleshooting	38
Checkpoints	38
Information codes	43
Technical specifications	43
Appendix	44
Open Source Announcement	44

Safety instructions

IMPORTANT SAFETY INSTRUCTIONS

READ CAREFULLY AND KEEP FOR FUTURE REFERENCE.

WARNING: If the door or door seals are damaged, the oven must not be operated until it has been repaired by a competent person.

WARNING: It is hazardous for anyone other than a competent person to carry out any service or repair operation that involves the removal of a cover which gives protection against exposure to microwave energy.

WARNING: Liquids and other foods must not be heated in sealed containers since they are liable to explode.

WARNING: Only allow children to use the oven without supervision when adequate instructions have been given so that the child is able to use the oven in a safe way and understands the hazards of improper use.

This appliance is intended to be used in household only and it is not intended to be used such as:

- staff kitchen areas in shops, offices and other working environments;
- farm houses;

- by clients in hotels, motels and other residential environments;
- bed and breakfast type environments.

Only use utensils that are suitable for use in microwave ovens. When heating food in plastic or paper containers, keep an eye on the oven due to the possibility of ignition.

The microwave oven is intended for heating food and beverages. Drying of food or clothing and heating of warming pads, slippers, sponges, damp cloth and similar may lead to risk of injury, ignition or fire.

If smoke is observed (emitted), switch off or unplug the appliance and keep the door closed in order to stifle any flames.

Microwave heating of beverages can result in delayed eruptive boiling, therefore care must be taken when handling the container.

The contents of feeding bottles and baby food jars shall be stirred or shaken and the temperature checked before consumption, in order to avoid burns.

Safety instructions

Eggs in their shell and whole hard-boiled eggs should not be heated in microwave ovens since they may explode, even after microwave heating has ended.

The oven should be cleaned regularly and any food deposits removed.

Failure to maintain the oven in a clean condition could lead to deterioration of the surface that could adversely affect the life of the appliance and possibly result in a hazardous situation.

The appliance is intended to be used built-in only. The appliance shall not be placed in a cabinet.

Metallic containers for food and beverages are not allowed during microwave cooking.

The care should be taken not to displace the turntable when removing containers from the appliance. (Turntable models only)

The appliance shall not be cleaned with a steam cleaner.

The appliance should not be cleaned with a water jet.

The appliance is not intended for installing in road vehicles, caravans and similar vehicles etc.

This appliance is not intended for use by persons (including children) with reduced physical, sensory or mental capabilities, or lack of experience and knowledge, unless they have been given supervision or instruction concerning use of the appliance by a person responsible for their safety.

Children should be supervised to ensure that they do not play with the appliance.

This appliance can be used by children aged from 8 years and above and persons with reduced physical, sensory or mental capabilities or lack of experience and knowledge if they have been given supervision or instruction concerning use of the appliance in a safe way and understand the hazards involved.

Children shall not play with the appliance. Cleaning and user maintenance shall not be made by children without supervision.

This Appliance should be allowed to disconnect from the supply after installation. The disconnection may be achieved by having the plug accessible or by incorporating a switch in the fixed wiring in accordance with the wiring rules.

If supply cord without plug is installed on the appliance, the means for disconnection must be incorporated in the fixed wiring in accordance with the wiring rules.

If the supply cord is damaged, it must be replaced by the manufacturer, its service agent or similarly qualified persons in order to avoid a hazard.

The method of fixing stated is not to depend on the use of adhesives since they are not considered to be a reliable fixing means.

This oven should be positioned proper direction and height permitting easy access to cavity and control area.

Before using the your oven first time, oven should be operated with the water during 10 minute and then used.

If the oven generates a strange noise, a burning smell, or smoke is emitted, unplug the power plug immediately and contact your nearest service center.

WARNING: When the appliance is operated in the combination mode, children should only use the oven under adult supervision due to the temperatures generated.

During use the appliance becomes hot. Care should be taken to avoid touching heating elements inside the oven.

If this appliance has cleaning function, during cleaning conditions, the surfaces may get hotter than usual and children should be kept away. The cleaning function depends on the model.

WARNING: Accessible parts may become hot during use. Young children should be kept away.

Do not use harsh abrasive cleaners or sharp metal scrapers to clean the oven door glass since they can scratch the surface, which may result in shattering of the glass.

A steam cleaner is not to be used.

WARNING: Ensure that the appliance is switched off before replacing the lamp to avoid the possibility of electric shock.

The appliance must not be installed behind a decorative door in order to avoid overheating.

Safety instructions

WARNING: The appliance and its accessible parts become hot during use.

Care should be taken to avoid touching heating elements.

Children less than 8 years of age shall be kept away unless continuously supervised.

CAUTION: The cooking process has to be supervised. A short term cooking process has to be supervised continuously.

The door or the outer surface may get hot when the appliance is operating.

The temperature of accessible surfaces may be high when the appliance is operating.

The surfaces are liable to get hot during use.

The Appliances are not intended to be operated by means of an external timer or separate remote-control system.

This appliance can be used by children aged from 8 years and above and persons with reduced physical, sensory or mental capabilities or lack of experience and knowledge if they have been given supervision or instruction concerning use of the appliance in a safe way and understand the hazards involved. Children shall not play with the appliance. Cleaning and user maintenance shall not be made by children unless they are older than 8 and supervised.

Keep the appliance and its cord out of reach of children less than 8 years.

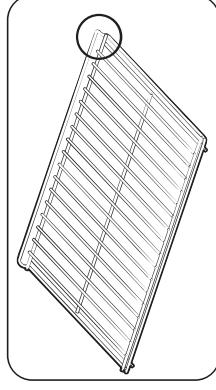

Please put the bent up frame side to the back, in order to support the reposition when cooking big loads. (Depending on model)

General safety

Any modifications or repairs must be performed by qualified personnel only. Do not heat food or liquids sealed in containers for the microwave function. Do not use benzene, thinner, alcohol, or steam or high-pressure cleaners to clean the oven.

Do not install the oven: near a heater or flammable material; locations that are humid, oily, dusty or exposed to direct sunlight or water; or where gas may leak; or an uneven surface.

This oven must be properly grounded in accordance with local and national codes. Regularly use a dry cloth to remove foreign substances from the power plug terminals and contacts.

Do not pull, excessively bend, or place heavy objects on the power cord.

If there is a gas leak (propane, LP, etc) ventilate immediately. Do not touch the power cord.

Do not touch the power cord with wet hands.

While the oven is operating, do not turn it off by unplugging the power cord.

Do not insert fingers or foreign substances. If foreign substances enter the oven, unplug the power cord and contact a local Samsung service centre.

Do not apply excessive pressure or impact to the oven.

Do not place the oven over fragile objects.

Ensure the power voltage, frequency, and current matches the product specifications.

Firmly plug the power plug into the wall socket. Do not use multiple plug adapters, extension cords, or electric transformers.

Do not hook the power cord on metal objects. Make sure the cord is between objects or behind the oven.

Do not use a damaged power plug, power cord, or loose wall socket. For damaged power plugs or cords, contact a local Samsung service centre.

Do not pour or directly spray water onto the oven.

Do not place objects on the oven, inside, or on the oven door.

Do not spray volatile materials such as insecticide on the oven.

Do not store flammable materials in the oven. Because alcohol vapours can contact hot parts of the oven, use caution when heating food or drinks containing alcohol. Children may bump themselves or catch their fingers on the door. When opening/closing the door, keep children away.

Microwave warning

Microwave heating of beverages may result in delayed eruptive boiling; always use caution when handling the container. Always allow beverages to stand at least 20 seconds before handling. If necessary, stir during heating. Always stir after heating.

In the event of scalding, follow these First Aid instructions:

1. Immerse the scalded area in cold water for at least 10 minutes.
2. Cover with a clean, dry dressing.
3. Do not apply any creams, oils, or lotions.

To avoid damaging the tray or rack, do not put the tray or rack in water shortly after cooking.

Do not use the oven for deep fat frying because the oil temperature cannot be controlled. This could result in a sudden boil over of hot oils.

Safety instructions

Microwave oven precautions

- Only use microwave-safe utensils. Do not use metallic containers, gold or silver trimmed dinnerware, skewers, etc.
- Remove wire twist ties. Electric arcing may occur.
- Do not use the oven to dry papers or clothes.
- Use shorter times for small amounts of food to prevent overheating or burning.
- Keep the power cord and power plug away from water and heat sources.
- To avoid the risk of explosion, do not heat eggs with shells or hard-boiled eggs. Do not heat airtight or vacuum-sealed containers, nuts, tomatoes, etc.
- Do not cover the ventilation slots with cloth or paper. This is a fire hazard. The oven may overheat and turn off automatically and will remain off until it cools sufficiently.
- Always use oven mitts when removing a dish.
- Stir liquids halfway during heating or after heating ends and allow the liquid stand at least 20 seconds after heating to prevent eruptive boiling.
- Stand at arms length from the oven when opening the door to avoid getting scalded by escaping hot air or steam.
- Do not operate the oven when it is empty. The oven will automatically shut down for 30 minutes for safety purposes. We recommend placing a glass of water inside the oven at all times to absorb microwave energy in case the oven is started accidentally.
- Install the oven in compliance with the clearances in this manual. (See Installing your microwave oven.)
- Use caution when connecting other electrical appliances to sockets near the oven.

Microwave operation precautions

- Failure to observe the following safety precautions may result in harmful exposure to microwave energy.
- Do not operate the oven with the door open. Do not tamper with the safety interlocks (door latches). Do not insert anything into the safety interlock holes.
 - Do not place any object between the oven door and front face or allow food or cleaner residue to accumulate on sealing surfaces. Keep the door and door sealing surfaces clean by wiping with a damp cloth and then with a soft, dry cloth after each use.
 - Do not operate the oven if it is damaged. Only operate after it has been repaired by a qualified technician.
 - **Important:** the oven door must close properly. The door must not be bent; the door hinges must not be broken or loose; the door seals and sealing surfaces must not be damaged.
 - All adjustments or repairs must be done by a qualified technician.

Limited warranty

Samsung will charge a repair fee for replacing an accessory or repairing a cosmetic defect if the damage to the unit or accessory was caused by the customer. Items this stipulation covers include:

- Door, handles, out-panel, or control panel that are dented, scratched, or broken.
- A broken or missing tray, guide roller, coupler, or wire rack.

Use this oven only for its intended purpose as described in this instruction manual. Warnings and Important Safety Instructions in this manual do not cover all possible conditions and situations that may occur. It is your responsibility to use common sense, caution, and care when installing, maintaining, and operating your oven.

Because these following operating instructions cover various models, the characteristics of your microwave oven may differ slightly from those described in this manual and not all warning signs may be applicable. If you have any questions or concerns, contact a local Samsung service centre or find help and information online at www.samsung.com.

Use this oven for heating food only. It is intended for domestic use only. Do not heat any type of textiles or cushions filled with grains. The manufacturer cannot be held liable for damage caused by improper or incorrect use of the oven. To avoid deterioration of the oven surface and hazardous situations, always keep the oven clean and well maintained.

Product group definition

This product is a Group 2 Class B ISM equipment. The definition of group 2 which contains all ISM equipment in which radio-frequency energy is intentionally generated and/or used in the form of electromagnetic radiation for the treatment of material, and EDM and arc welding equipment.

For Class B equipment is equipment suitable for use in domestic establishments and in establishments directly connected to a low voltage power supply network which supplies buildings used for domestic purposes.

Correct Disposal of This Product (Waste Electrical & Electronic Equipment)

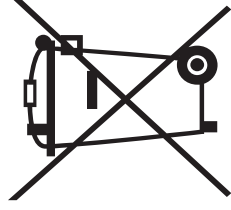

(Applicable in countries with separate collection systems)
This marking on the product, accessories or literature indicates that the product and its electronic accessories (e.g. charger, headset, USB cable) should not be disposed of with other household waste at the end of their working life. To prevent possible harm to the environment or human health from uncontrolled waste disposal, please separate these items from other types of waste and recycle them responsibly to promote the sustainable reuse of material resources.

Household users should contact either the retailer where they purchased this product, or their local government office, for details of where and how they can take these items for environmentally safe recycling.

Business users should contact their supplier and check the terms and conditions of the purchase contract. This product and its electronic accessories should not be mixed with other commercial wastes for disposal.

For information on Samsung's environmental commitments and product-specific regulatory obligations, e.g. REACH, WEEE, Batteries, visit : www.samsung.com/uk/aboutsamsung/sustainability/environment/our-commitment/data/

Installation

What's included

Make sure all parts and accessories are included in the product package. If you have a problem with the oven or accessories, contact a local Samsung customer centre or the retailer.

Oven at a glance

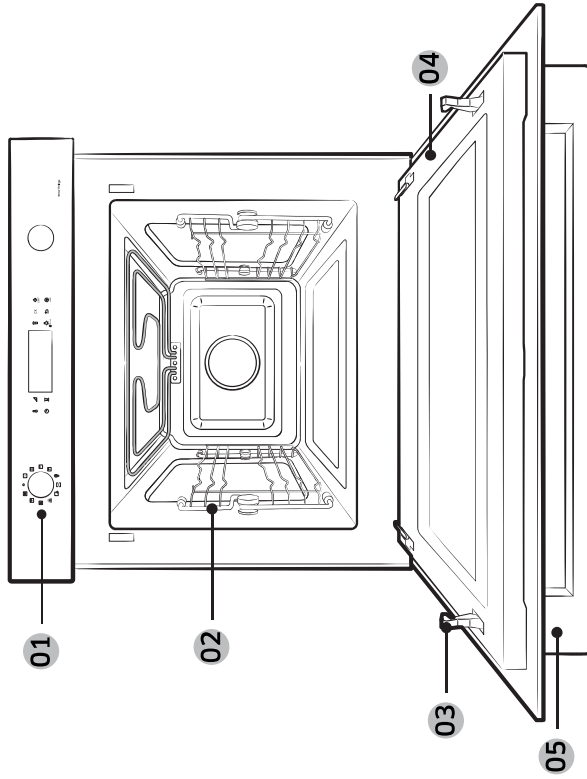

- 01 Control panel
- 02 Side racks
- 03 Safety door lock
- 04 Door
- 05 Door Handle

Accessories

The oven comes with different accessories that help you prepare different types of food.



Ceramic tray
(Useful for microwave mode.)



Baking tray
(Do not use for microwave mode.)

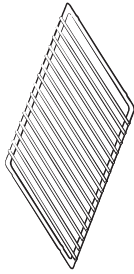

Wire tray insert
(Useful for speed menu and grill mode.)



3 Screws (M4 L25)

NOTE

See the **Cooking Smart** on page 31-38 to determine the appropriate accessory for your dishes.

Installation instructions

General Technical Information

Electrical Supply	230 V ~ 50 Hz	
Dimensions (W x H x D)	Set size	595 x 456 x 570 mm
	Built in size	560 x 446 x 549 mm

This appliance complies with EU regulations.

Disposal of Packaging and Appliance

Packaging is recyclable.

Packaging may consist of the following materials:

- cardboard;
- polyethylene film (PE);
- CFC-free polystyrene(PS rigid foam).

Please dispose of these materials in a responsible manner in accordance with government regulations.

The authorities can provide information on how to dispose of domestic appliances in a responsible manner.

Safety

- This appliance should only be connected by a qualified technician.
- The Oven is NOT designed for use in a commercial cooking setting.
- It should be used exclusively for cooking food in a home setting.
- The appliance is hot during and after use.
- Exercise caution when young children are present.

Electrical Connection

The house mains to which the appliance is connected should comply with national and local regulations.

Appliance should allow to disconnection of the appliance from the supply after installation. The disconnection may be achieved by having the plug accessible or by incorporating a switch in the fixed wiring in accordance with the wiring rules.

Install in the Cabinet

Kitchen Cabinets in contact with the oven must be heatresistant up to 100 °C. Samsung will take no responsibility for damage of cabinets from the heat.

Required Dimensions for installation (This product is dedicated to built-in products.)

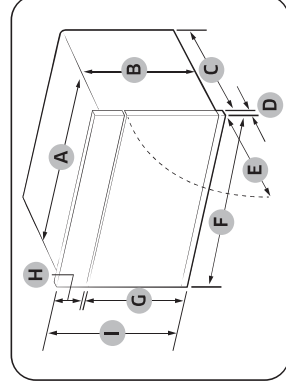

Oven (mm)

A	560	F	595
B	446	G	354
C	549	H	85
D	21	I	456
E	341		

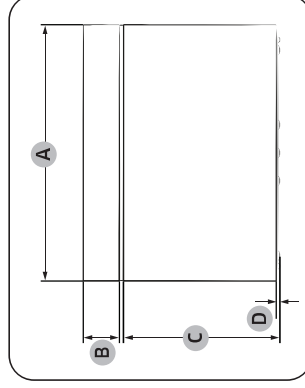

Oven (mm)

A	595
B	85
C	367
D	6

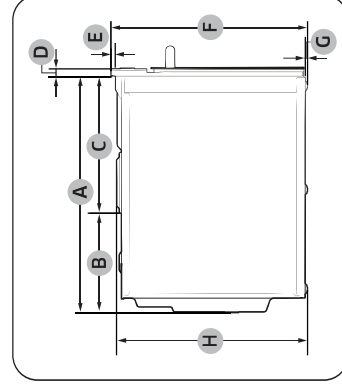

Oven (mm)

A	549	E	10
B	233	F	456
C	316	G	6
D	21	H	446

Installation

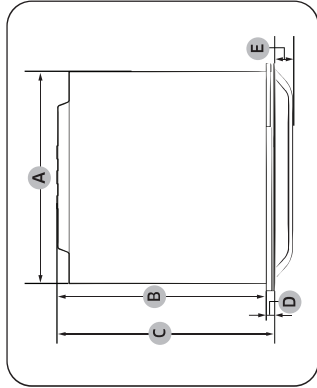

Oven (mm)

A	560	D	21
B	549	E	45
C	570		

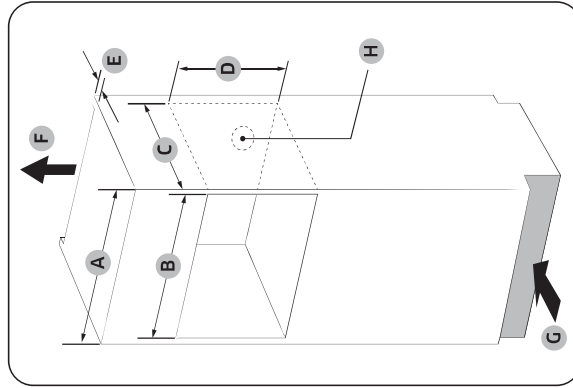

Built-in cabinet (mm)

A	600
B	Min. 564-568
C	Min. 550
D	Min. 446 / Max. 450
E	Min. 50
F	200 cm ²
G	200 cm ²
H	Space for power outlet (30 Ø Hole)

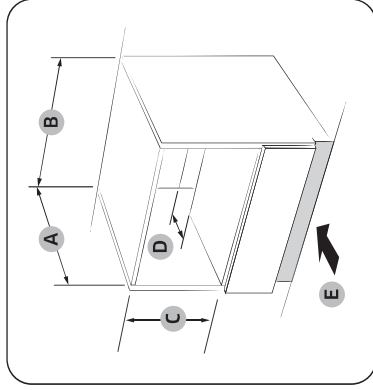

Under-sink cabinet (mm)

A	Min. 550
B	Min. 564 / Max. 568
C	Min. 446 / Max. 450
D	50
E	200 cm ²

NOTE

Minimum height requirement **(C)** is for oven installation alone.

Installing with a hob

To install a hob on top of the oven, check the installation guide of the hob for the installation space requirement **(*)**.

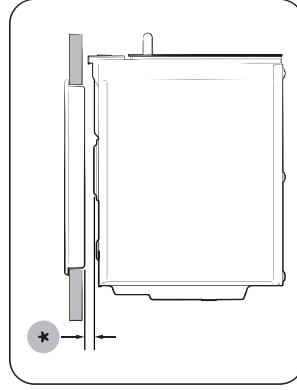

Mounting the oven

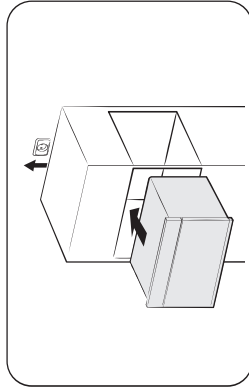

1. Slide the oven partly into the recess. Lead the connection cable to the power source.

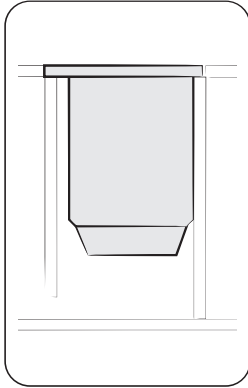

2. Slide the oven completely into the recess.

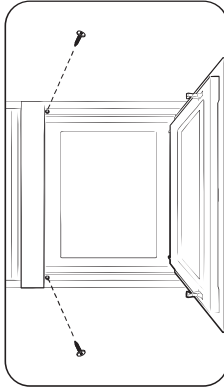

3. Fasten the oven using the two screws (4 x 25 mm) provided.

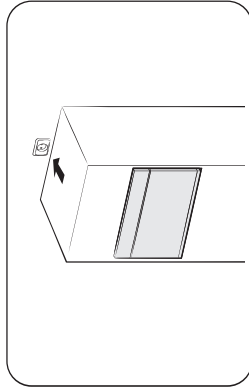

4. Make the electrical connection. Check that the appliance works.

Be sure to hold the appliance with 2 side handles and door handle when unpacking the product.

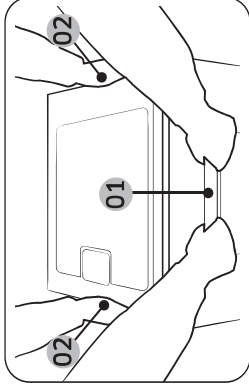

- 01 Door handle
- 02 Side handle

After the installation is complete, remove the protective film, tape, and other packing material, and take out the provided accessories from inside of the oven. To remove the oven from the cabinet, first disconnect power to the oven and remove 2 screws on both sides of the oven.

Maintenance

Cleaning

Clean the oven regularly to prevent impurities from building up on or inside the oven. Also pay special attention to the door, door sealing (applicable models only). If the door won't open or close smoothly, first check if the door seals have built up impurities. Use a soft cloth in soapy water to clean both the inner and outer sides of the oven. Rinse and dry well.

To remove stubborn impurities with bad smells from inside the oven

1. With an empty oven, put a cup of diluted lemon juice on the centre of the cavity.
2. Heat the oven for 10 minutes at max power.
3. When the cycle is complete, wait until the oven cools down. Then, open the door and clean the cooking chamber.

CAUTION

- Keep the door and door sealing clean and ensure the door opens and closes smoothly. Otherwise, the oven's lifecycle may be shortened.
- Take caution not to spill water into the oven vents.
- Do not use any abrasive or chemical substances for cleaning.
- After each use of the oven, use a mild detergent to clean the cooking chamber after waiting for the oven to cool down.

Replacement (repair)

WARNING

This oven has no user-removable parts inside. Do not try to replace or repair the oven yourself.

- If you encounter a problem with hinges, sealing, and/or the door, contact a qualified technician or a local Samsung service centre for technical assistance.
- If you want to replace the light bulb, contact a local Samsung service centre.
- Do not replace it yourself.
- If you encounter a problem with the outer housing of the oven, first unplug the power cord from the power source, and then contact a local Samsung service centre.

Care against an extended period of disuse

If you don't use the oven for an extended period of time, unplug the power cord and move the oven to a dry, dust-free location. Dust and moisture that builds up inside the oven may affect the performance of the oven.

Before you start

There are a couple of components that you should know before going directly to a recipe.

Control panel

The front panel comes in a wide range of materials and colours. For improved quality, the actual appearance of the oven is subject to change without notice.

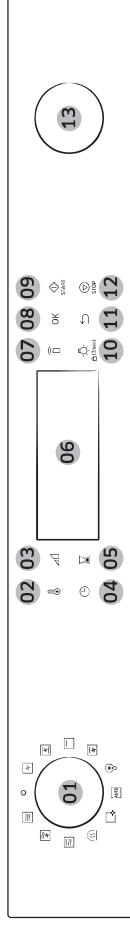

01 Mode Dial	Turn the Mode Dial to wake the control panel or to select a desired cooking mode or function.
02 Temperature	Use to change the temperature.
03 Power Level	Use to change the power level.
04 Clock	Tap to change the current time.
05 Timer	Tap to use kitchen timer function.
06 Screen	Displays the menu, information and cooking progress.
07 Smart Control	Set the Smart Control function on or off.
08 OK	<p>NOTE Easy Connection should be set prior to use this function.</p> Select the current value.
09 Start	Tap to start the oven operation.
10 Light	Tap to turn the oven light on or off. <ul style="list-style-type: none"> Tap and hold for 3 seconds to activate or deactivate. Child Lock is available only in standby state.
11 Back	Tap to move to the previous screen or to cancel the cooking.
12 Stop	Tap to stop the oven operation.
13 Value Dial	Turn the Value Dial to adjust the setting value for your selection. Turn to the right to increase or turn to the left to decrease.

Clock

It is important to set the correct time to ensure correct automatic operations.

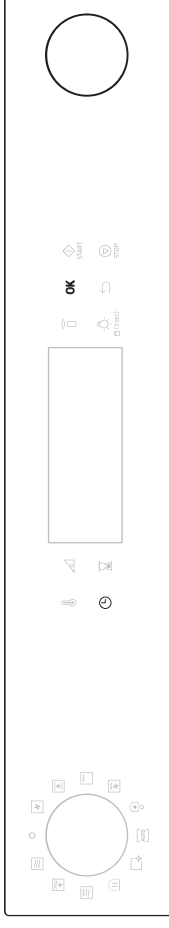

To set the clock time

1. Tap and hold for 3 seconds.
2. Set the clock time(hour and minute) using the **Value Dial** and **OK** button.

NOTE

- You cannot change the clock time while the oven is operating.

Before you start

Side racks

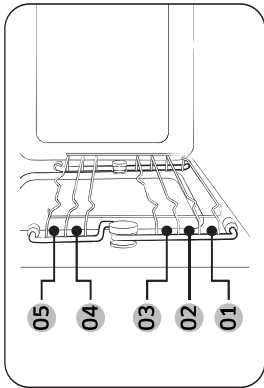

- Insert the accessory to the correct position inside of the oven.
- Take caution in removing cookware and/or accessories out of the oven. Hot meals or accessories can cause burns.

	Microwave function
01 Level 1	Oven function
02 Level 2	
03 Level 3	
04 Level 4	
05 Level 5	

About microwave energy

Microwaves are high-frequency electromagnetic waves. The oven uses the prebuilt magnetron to generate microwaves which are used to cook or reheat food without deforming or discolouring the food.

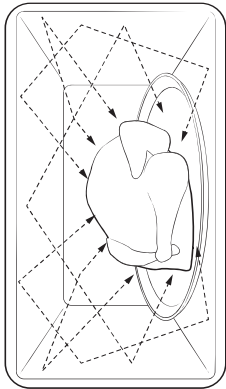

1. The microwaves generated by the magnetron are distributed uniformly through the whirling distribution system. This is why the food is cooked evenly.
2. The microwaves are absorbed down to the food up to a depth of approx. 2.5 cm. Then, the microwaves are dissipated inside the food as cooking continues.
3. The cooking time is affected by the following conditions of the food.
 - Quantity and density
 - Moisture content
 - Initial temperature (especially, when frozen)

NOTE

The cooked food keeps heat in its core after cooking is complete. This is why you must respect the standing time specified in this manual, which ensures cooking evenly down to the core.

Cookware for microwave

Cookware used for Microwave Mode must allow microwaves to pass through and penetrate the food. Metals such as stainless steel, aluminium and copper reflect microwaves. Therefore, do not use cookware made of metallic materials. Cookware marked microwave-safe is always safe for use. For additional information on appropriate cookware refer to the following guidelines and place a glass of water or some food inside the cavity.

Requirements:

- Flat bottom and straight sides
- Tight-fitting lid
- Well-balanced pan with handles that weigh less than the main pan

Material	Microwave-safe	Description
Aluminium foil	△	Use for a small serving size to protect against overcooking. Arcing can occur if the foil is near the oven wall or if using an excessive amount of foil.
Crusty plate	○	Do not use for preheating for more than 8 minutes.
Bone china or earthenware	○	Porcelain, pottery, glazed earthenware, and bone china are usually microwave-safe unless decorated with a metal trim.
Disposable polyester cardboard dishes	○	Some frozen foods are packaged in these dishes.

Material		Microwave-safe	Description
Fast-food packaging	Polystyrene cups or containers	○	Overheating may cause these to melt.
	Paper bags or newspaper	×	These may catch fire.
	Recycled paper or metal trims	×	These may cause arcing.
Glassware	Oven-to-table ware	○	Microwave-safe unless decorated with metal trims.
	Fine glassware	○	Delicate glassware may break or crack by rapid heating.
	Glass jars	○	Appropriate for warming only. Remove the lid before cooking.
Metal	Dishes	×	These may cause arcing or fire.
	Freezer bag with twist-ties	×	
Paper	Plates, cups, napkins, and kitchen paper	○	Use to cook for a short time. These absorb excess moisture.
	Recycled paper	×	Causes arcing.





Before you start







Material	Microwave-safe	Description
Plastic	○	Use thermoplastic containers only. Some plastics may warp or discolour at high temperatures.
	○	Use to maintain moisture after cooking.
	△	Use boilable or ovenproof bags only.
Wax or grease-proof paper	○	Use to maintain moisture and prevent spattering.

○ : Microwave-safe △ : Use caution X : Not microwave-safe

Operations

Feature overview

Feature	Temperature (Power level) range	Default temperature (Power level)
	100-800 W	800 W
	The microwave energy enables food to be cooked or reheated without changing either the form or the colour.	
	40-200 °C 100 W-600 W	180 °C 300 W
	The heating elements generate heat, and the convection fan distributes the heat inside the oven, which is reinforced by the microwave energy.	
	40-200 °C 100 W-600 W	200 °C 300 W
	The heating elements generate heat, which is reinforced by the microwave energy.	
	40-230 °C	160 °C
	The rear heating element generates heat, which is evenly distributed by the convection fan. Use this mode for baking and roasting on different levels at the same time.	
	40-230 °C	180 °C
	The heat is generated from the top and bottom heating elements with fans. This setting is suitable for baking and roasting.	
Manual Mode		

Feature		Temperature (Power level) range	Default temperature (Power level)
Manual Mode		150-230 °C	220 °C
		40-230 °C	180 °C
Auto Mode		Two top heating elements generate heat, which is distributed by the fan. Use this mode for grilling meat or fish.	
		For cooking beginners, the oven offers a total of 20 auto cooking programmes.	
		60-100 °C	60 °C
Special functions		Use this only for keeping foods warm that have just have been cooked.	
		The oven offers Steam Clean and Deodorisation functions. Steam Clean is useful for cleaning light soiling with steaming. Also, Deodorisation is useful for deodorising the oven.	

Manual mode

The default temperature (or Power level) changes according to the most frequently used setting for the last 10 operations.

Step 1. Select a mode

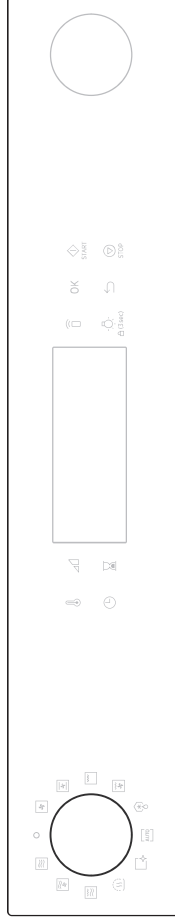

1. Use the **Mode Dial** to wake the control panel, and then select a manual mode.

Step 2. Set the temperature

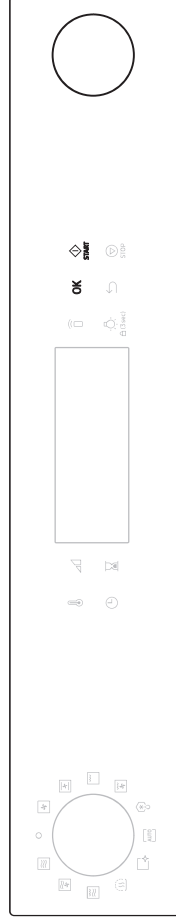

1. Turn the **Value Dial** to select the desired temperature.
2. When done, tap **OK**.
3. If you want a quick start, tap **START**. The oven starts preheating. (Available for Convection, Fan Conventional, Large Grill, Fan Grill modes)

Operations

Step 3. Set the cooking time (and Power level)

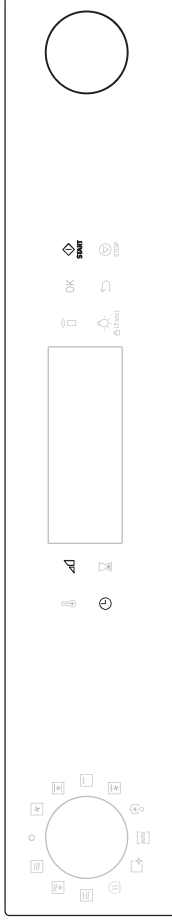

1. Turn the **Value Dial** to select the cooking time. If you tap **OK**, you can set cooking time.
2. To set end time, tap **OK** one more time and turn **Value Dial** to set desired end time.
3. To change the power level, tap **▲** and turn **Value Dial** to change.
4. When done, tap **START** to start cooking.
5. Also, you can set options before you start the oven.

CAUTION

Do not keep cooked food in the oven for too long. The food may spoil.

Step 4. Preheat (Convection, Fan Conventional, Large Grill, Fan Grill, Air Fry only)

The oven starts preheating until it reaches the set temperature. When complete, the oven beeps and preheat indicator disappears.

To change the temperature (or Power level) and cook time during cooking

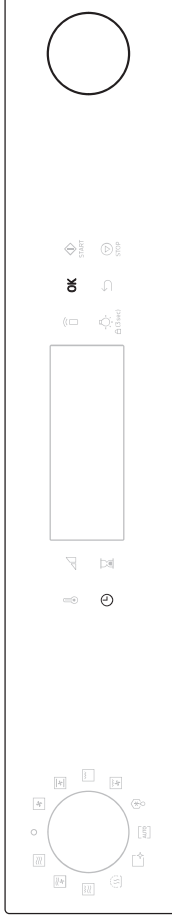

1. Tap **OK** during cooking.
2. Select temperature (or power level) or cook time using the **Value Dial**.
3. Tap **OK**.
4. Change the value using the **Value Dial**. If you tap **OK**, you can change the value.
5. To change cooking time only, tap **OK**. Then, change the cooking time you desire.

To stop the operation

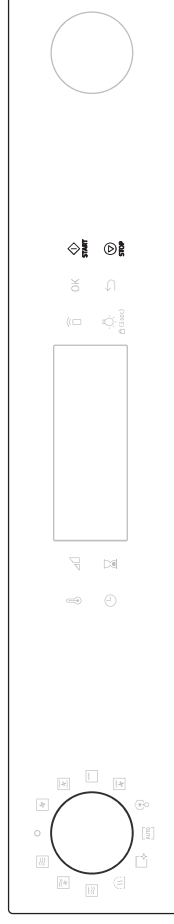

1. Turn the **Mode Dial** to off.
 - The oven display turns off, and the clock appears after 2 seconds.
 - The oven turns off even during cooking, and the clock appears after 2 seconds.
2. Tap **STOP**.
 - The oven pauses. Tap it again to cancel or tap **START** to resume cooking.

Microwave

Microwaves are high-frequency electromagnetic waves. The microwave energy enables food to be cooked or reheated without changing either the form or the colour.

- Use only microwave-safe cookware.

Step 1	Step 2	Step 3	Step 4
Microwave	>	Cooking time (Power Level)	>

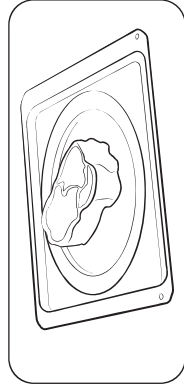

1. Put food in microwave-safe container, put the container on the recommended accessory, and then close the door.
2. Follow steps 1-3 in the **Manual mode** section on page 19-20. The oven will start after setting the cooking time.
3. When cooking is complete, use oven gloves to take out food.

Power level

Level	Percentage (%)	Output power (W)	Description
HIGH	100	800	Use to heat up liquid.
HIGH LOW	88	700	Use to heat up and cook.
	75	600	
MEDIUM	56	450	Use to cook meat and heat up vegetables.
MEDIUM LOW	38	300	
DEFROST	22	180	Use to defrost before cooking.
LOW	13	100	Use to defrost vegetables.

Microwave + Convection

This combination mode combines the microwave energy with hot air, resulting in reduced cooking time and producing a brown, crispy surface of the food. Use this for all kinds of meat and poultry as well as casseroles and gratin dishes, sponge cakes and light fruit cakes, pies and crumbles, roast vegetables, scones, and breads.

Step 1	Step 2	Step 3	Step 4
Microwave + Convection	>	Temperature	>
		Cooking time (Power Level)	>

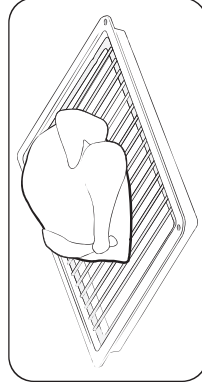

1. Put food in suitable cookware, put the cookware on the rack, and then close the door.
2. Follow steps 1-3 in the **Manual mode** section on page 19-20. The oven will start after setting the cooking time.
3. When cooking is complete, use oven gloves to take out food.

CAUTION

Use only ovenproof cookware, such as glasses, potteries, or bone china without metal trim.

Operations

Microwave + Grill

The heating elements generate heat, which is reinforced by the microwave energy. Use only microwave-safe cookware, such as glass or ceramic cookware.

Step 1	>	Step 2	>	Step 3	>	Step 4
Microwave + Grill		Temperature		Cooking time (Power level)		-

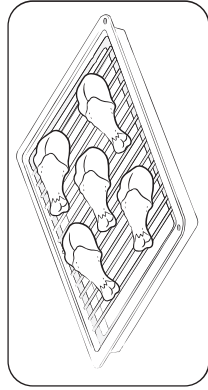

1. Put food in suitable cookware, put the cookware on the recommended accessory, and then close the door.
2. Follow steps 1-3 in the **Manual mode** section on page 19-20. The oven will start after setting the cooking time.
3. When cooking is complete, use oven gloves to take out food.

CAUTION

Use only ovenproof cookware, such as glasses, potteries, or bone china without metal trim.

Convection

The heating elements generate heat, which is evenly distributed inside the oven by the convection fan. Use this mode for biscuits, individual scones, rolls, and cakes as well as fruit cakes, choux, and soufflés.

Step 1	>	Step 2	>	Step 3	>	Step 4
Convection		Temperature		Cooking time		Preheating

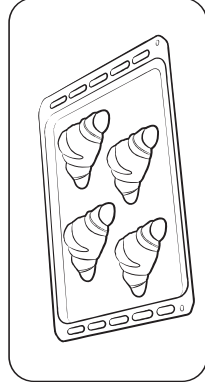

1. Put food in suitable cookware, put the cookware on the recommended accessory, and then close the door.
2. Follow steps 1-4 in the **Manual mode** section on page 19-20.
3. When cooking is complete, use oven gloves to take out food.

Fan Conventional

The heat is generated from the top and bottom heating elements with fans. This function should be used for standard baking and roasting for most types of dishes.

Step 1	>	Step 2	>	Step 3	>	Step 4
Fan Conventional		Temperature		Cooking time		Preheating

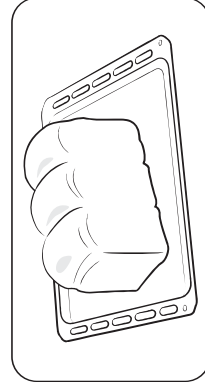

1. Put food in suitable cookware, put the cookware on the recommended accessory, and then close the door.
2. Follow steps 1-4 in the **Manual mode** section on page 19-20.
3. When cooking is complete, use oven gloves to take out food.

 **Large Grill**

The heating elements generate heat. Make sure they are in the horizontal position.

- Step 1 > Step 2 > Step 3 > Step 4
- Grill > Temperature > Cooking time > Preheating

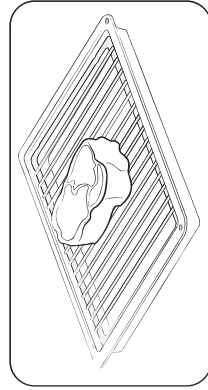

1. Put food in suitable cookware, put the cookware on the recommended accessory, and then close the door.
2. Follow steps 1-4 in the **Manual mode** section on page 19-20.
3. When cooking is complete, use oven gloves to take out food.

 **Fan Grill**

The heating elements generate heat. Make sure they are in the horizontal position.

- Step 1 > Step 2 > Step 3 > Step 4
- Grill > Temperature > Cooking time > Preheating

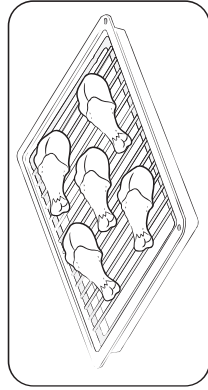



1. Put food in suitable cookware, put the cookware on the recommended accessory, and then close the door.
2. Follow steps 1-4 in the **Manual mode** section on page 19-20.
3. When cooking is complete, use oven gloves to take out food.

Auto mode

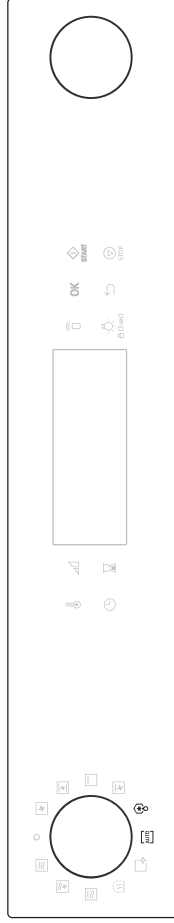
The oven offers 2 different auto modes for your convenience: Auto Defrost and Auto Cook. Select one that best fits your needs.



1. Use the **Mode Dial** to wake the control panel, select an Auto mode and then tap **OK** to confirm.
 - Auto Cook () , Auto Defrost () .
2. Turn the **Value Dial** to select the preferred programme and tap **OK** to confirm.
3. Turn the **Value Dial** to set the desired weight and then tap **OK** to confirm.
4. The display shows the menu and accessory guide. (Tap **OK**.)
5. Tap **START** or **OK** to start cooking.

 **CAUTION**

Always use oven gloves while taking out food.

 **NOTE**

The cooking time is pre-programmed for each menu and, it cannot be changed.

Operations

Auto Cook

For cooking beginners, the oven offers a total of 20 auto cooking programmes. Take advantage of this feature to save you time or shorten your learning curve. The cooking time and temperature will be adjusted according to the selected recipe.

Step 1

Auto cook

Step 2

Menu

Step 3

Weight

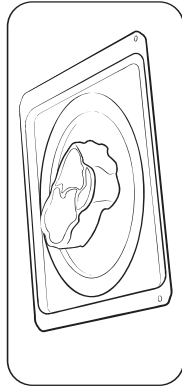

1. Put food in suitable cookware, put the cookware on the recommended accessory, and then close the door.
2. Follow steps 1-3 in the **Auto mode** section on page 23-25.
3. When cooking is complete, use oven gloves to take out food.

Auto cook guide

No.	Food	Serving size (kg)	Accessory	Level
1	Plated Meal	0.3-0.4 0.4-0.5	Ceramic tray	1
2	Frozen Pizza	0.3-0.4 0.4-0.5	Wire tray insert + Ceramic Tray	2
3	Frozen Lasagne	0.4-0.5 0.6-0.7	Wire tray insert + Ceramic Tray	2
4	Whole Chicken	1.1-1.2 1.2-1.3	Wire tray insert + Ceramic Tray	2
5	Chicken Pieces	0.6-0.7 0.9-1.0	Wire tray insert + Ceramic Tray	4

Put on a ceramic plate and cover with microwave cling film. This programme is suitable for meals consisting of 3 components (e.g. meat with sauce, vegetables and a side dish like potatoes, rice or pasta). After cooking stand for 3 min.

Put frozen lasagne in a suitable glass pyrex or ceramic dish. After reheating let stand for 2-3 minutes.

Brush chilled chicken with oil and spices. Put breast-side-down, in the middle of Wire tray insert rack with ceramic tray. Turnover, as soon as the oven beeps. Put Start button to continue process. After cooking let stand for 5 minutes.

Brush chilled chicken pieces with oil and spices. Put on wire tray insert with ceramic tray with the skin-side down. Turnover, as soon as the oven beeps. After cooking let stand for 2-3 minutes.

No.	Food	Serving size (kg)	Accessory	Level
6	Roast Lamb	0.8-0.9	Wire tray insert + Ceramic Tray	3
		1.1-1.2		
7	Frozen Oven Chips	0.3-0.4	Baking tray	3
		0.4-0.5		
8	Baked Potato Halves	Distribute frozen oven chips on metal baking tray.		4
		0.4-0.5	Wire tray insert + Ceramic Tray	
9	Apple Pie	Cut potatoes into halves. Put them in a circle on the tray with the cut side to the grill. After cooking let stand for 2-3 minutes.		2
		1.2-1.4	Baking tray	
10	Dutch Loaf Cake	Put apple pie into a round metal dish. Put on the baking tray. The weight ranges include apple and so on.		3
		0.7-0.8	Baking tray	
11	Broccoli Florets	Put fresh dough into suitable sized rectangular metal baking dish (length 25 cm). Put dish length way to the door on baking tray.		1
		0.2-0.3	Ceramic tray	
12	Cauliflower Florets	0.3-0.4		1
		0.2-0.3	Ceramic tray	
Rinse and clean fresh Cauliflower and prepare florets. Put them evenly into a glass bowl with lid. Add 30 ml (2 tablespoons) water when cooking for 0.2-0.3 kg, and add 45-60 ml (3-4 tablespoons) for 0.3-0.4 kg. Put bowl in the centre of cavity. Cook covered. Stir after cooking.				

No.	Food	Serving size (kg)	Accessory	Level
13	Sliced Carrots	0.2-0.3	Ceramic tray	1
		0.4-0.5		
Rinse and clean carrots and prepare even slices. Put them evenly into a glass bowl with lid. Add 30 ml (2 tablespoons) water when cooking for 0.2-0.3 kg, and add 45-60 ml (3-4 tablespoons) for 0.4-0.5 kg. Put bowl in the centre of cavity. Cook covered. Stir after cooking.				
14	Jacket Potatoes	0.3-0.4	Ceramic tray	1
		0.7-0.8		
Rinse and clean potatoes, Brush with olive oil and pierce skin with a knife. Put on ceramic tray. After cooking, stand for 3-5 minutes.				
15	Peeled Potatoes	0.4-0.5	Ceramic tray	1
		0.7-0.8		
Rinse and peel potatoes, cut into halves and put into an oven-proof glass bowl with lid. Add 15-30 ml of water (1-2 tablespoons). Stir after cooking. When cooking higher quantities stir once during cooking. Stand for 3-5 minutes.				
16	Courgettes	0.2-0.3	Ceramic tray	1
		0.3-0.4		
Cut courgettes into slices. Add 30 ml (2 tablespoons) water or a knob of butter. Put them evenly into a glass bowl with lid. Cook covered. Cook until just tender.				
17	Sliced Egg Plants	0.1-0.2	Ceramic tray	1
		0.3-0.4		
Cut egg plants into small slices and sprinkle with 15 ml (1 tablespoon) lemon juice. Put them evenly into a glass bowl with lid. Cook covered. Stir after cooking.				

Operations

No.	Food	Serving size (kg)	Accessory	Level
18	Sliced Onions	0.2-0.3 0.4-0.5	Ceramic tray	1
19	Mixed Vegetables	0.2-0.3 0.4-0.5	Ceramic tray	1
20	White Rice	0.2-0.3	Ceramic tray	1

Cut onions into slices or halves. Add only 15 ml (1 tablespoon) water. Put them evenly into a glass bowl with lid. Cook covered. Stir after cooking.

Rinse and clean fresh vegetables. Put them evenly into a glass bowl with lid. Add 15 ml (1 tablespoon) water when cooking for 0.2-0.3 kg, and add 30 ml (2 tablespoons) for 0.4-0.5 kg. Put bowl in the centre of cavity. Cook covered. Stir after cooking.

Use a large glass Pyrex bowl with lid. (Note that rice doubles in volume during cooking.) Cook covered. After cooking time is over, stir before letting stand. Add salt or herbs and butter. Note that rice may not have absorbed all water after the cooking time is finished.

Defrost

The oven offers 5 defrosting programmes for your convenience. The time and power level are automatically adjusted according to the selected programme.

Step 1	Step 2	Step 3
Auto defrost	Menu	Weight
	<ol style="list-style-type: none"> Put food in suitable cookware, put the cookware on the recommended accessory, and then close the door. Follow steps 1-3 in the Auto mode section on page 23-25. When cooking is complete, use oven gloves to take out food. 	

Defrost guide

No.	Food	Serving size (kg)	Accessory	Level
1	Meat	0.2-1.5	Ceramic tray	1
2	Poultry	0.2-1.5	Ceramic tray	1
3	Fish	0.2-1.5	Ceramic tray	1

Shield the edges with aluminium foil. Turn the meat over, when the oven beeps. This programme is suitable for beef, lamb, pork, steaks, chops, minced meat.

Shield the leg and wing tips with aluminium foil. Turn the poultry over, when the oven beeps. This programme is suitable for whole chicken as well as for chicken portions.

Shield the tail of a whole fish with aluminium foil. Turn the fish over, when the oven beeps. This programme is suitable for whole fishes as well as for fish fillets.

No.	Food	Serving size (kg)	Accessory	Level
4	Bread/Cake	0.1-0.8	Ceramic tray	1
	Put bread on a piece of kitchen paper and turn over, as soon as the oven beeps. Place cake on ceramic tray and if possible, turn over, as soon as the oven beeps. (Oven keeps operating and is stopped, when you open the door.) This programme is suitable for all kinds of bread, sliced or whole, as well as for bread rolls and baguettes. Arrange bread rolls in a circle. This programme is suitable for all kinds of yeast cake, biscuit, cheese cake and puff pastry. It is not suitable for short / crust pastry, fruit and cream cakes as well as for cake with chocolate topping.			
5	Fruit	0.1-0.6	Ceramic tray	1
	Distribute frozen fruit evenly on ceramic tray. This programme is suitable for fruits like raspberries, mixed berries, and tropical fruits.			

Special functions

Keep Warm

With this function, only the convection heating element operates, and it cycles on and off to keep food warm.

When cooking is complete,

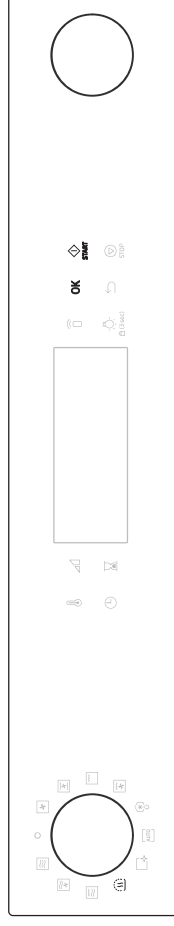

1. Use the **Mode Dial** to wake the control panel, and then select **Keep Warm** (🕒).
2. Tap **OK** to confirm.
3. Turn the **Value Dial** to select the desired temperature (60-100 °C).
4. When done, tap **OK**. If you want a quick start, tap **START**. The oven starts warming.
5. Turn the **Value Dial** to select the operating time.
6. When done, tap **OK** or **START** to start.

CAUTION

- Always use oven gloves while taking out food.
- Do not use this function to reheat cold foods. Use this only for keeping foods warm that just have been cooked.
- Do not run this function for more than 1 hour. Otherwise, this may affect food quality.
- To keep food crispy, do not cover the food when using this function.

Operations

Keep Warm guide

Food	Temperature (°C)	Standing time (min.)	Directions
Meals	80	30	For keeping meat, chicken, gratin, pizza, potatoes, and plated meals warm.
Drinks	80	30	For keeping water, milk, and coffee warm.
Breads/pastries	60	30	For keeping bread, toast, rolls, muffins, and cake warm.
Dishes/crockery	70	30	For preheating dishes and crockery. Arrange the dishes inside the cavity. Do not overload. (maximum load: 7 kg)

Cleaning

Cleaning offers Steam clean (🌀) and Deodorisation (👤) functions.

Steam Clean

This function is useful for cleaning light soiling with steaming.

1. Pour 100 ml of water onto the bottom of the oven and close the oven door.

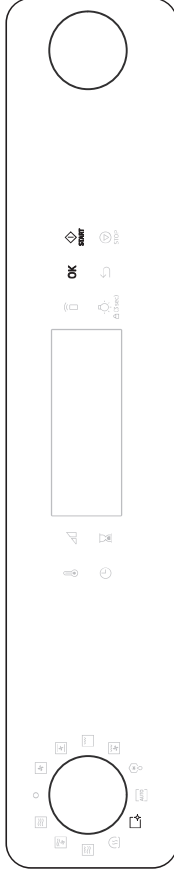
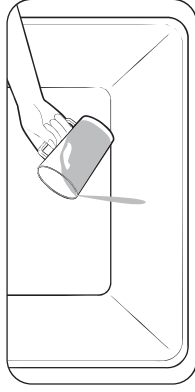

2. Use the **Mode Dial** to wake the control panel, and then select **Cleaning** (🌀).
3. Turn the **Value Dial** to select '**C1**' **Steam Clean** (🌀).
4. When done, tap **OK**. If you want a quick start, tap **START**. The oven starts cleaning.
5. Tap **OK** to read guide message.
6. When done, tap **OK** or **START** to start.

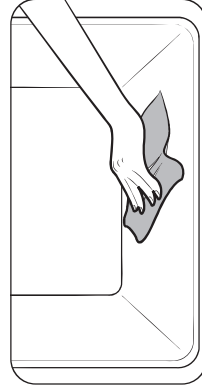

7. After completing **Steam Clean**, use a dry cloth to clean inside the oven.

⚠ WARNING

Do not open the door before the cycle is complete. The water inside the oven is very hot, and it can cause a burn.

📖 NOTE

- Use this feature only when the oven has cooled completely to room temperature.
- DO NOT use distilled water.
- DO NOT use high-pressure water cleaners or steam jet cleaners to clean the microwave oven.
- If the oven is hot inside, auto cleaning will not activate. Wait until the oven cools down, and then try again.
- Do not pour water onto the bottom by force. Do it gently. Otherwise, the water overflows to the front.

🧼 Deodorisation

This function is useful for deodorizing the oven. Use this function regularly to remove any unpleasant odour in your oven.

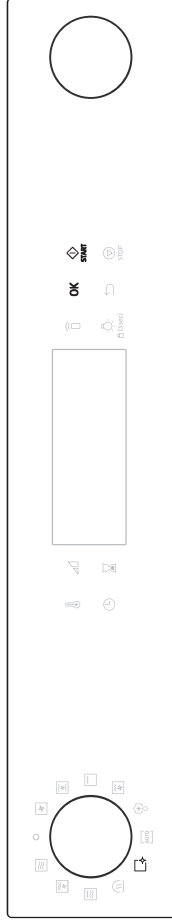



1. Use the **Mode Dial** to wake the control panel, and then select **Cleaning** (🧼).
2. Turn the **Value Dial** to select '**C2 Deodorisation**' (🧼).
3. When done, tap **OK**.
4. Turn the **Value Dial** to set time, and then tap **OK** or **START** to start. (Default set time is 5 minutes.)

More Functions

Menu	Description
Timer	You can set the timer.
Lock	You can lock the control panel.
Sound	You can turn the oven's sound (beeps) on or off.
Wi-Fi	You can turn the Wi-Fi on or off.

Operations

Timer

1. Tap  to use **Timer** function.
2. Set the timer (hour and minute) using the **Value Dial**.
3. Tap **OK** to start the timer.
4. Tap **STOP** to cancel the timer and tap  to edit the timer.

Lock

1. Tap and hold  for 3 seconds to lock the oven.
2. To unlock the oven, tap and hold  for 3 seconds.

Sound

1. Tap and hold  for 3 seconds to use **More Functions**.
2. Set option to number **1** by using **Value Dial** and tap **OK** button to change **Sound** setting.
3. Change the option on or off by using **Value Dial** button and then tap **OK**.



Wi-Fi

1. Tap and hold  for 3 seconds to use **More Functions**.
2. Set option to number **2** by using **Value Dial** and tap **OK** button to change **Wi-Fi** setting.
3. Change the option on or off by using **Value Dial** button and then tap **OK**.

Smart Control

To use the oven's Smart Control, you must download the SmartThings app to a mobile device. Functions operated by the SmartThings app may not work smoothly if communication conditions are poor or the oven is installed in a place with a weak Wi-Fi signal.

How to connect the microwave oven

1. Download and open the SmartThings app on your mobile device.
2. Follow the app's on-screen instructions to connect your oven.
3. Once the process is complete, the  icon located on your oven display, and the app will confirm you are connected.
4. If the  icon does not appear, follow the instruction on the app to reconnect.

To control the oven remotely

For safety reason, this function is not available for microwave mode.

1. Press Smart Control  appears in the display. The oven can now be controlled remotely with a connected remote device.
2. Select the oven icon on the SmartThings app to open the Oven Control app. When the app is connected to the oven, you can perform the following functions through the applications:

Oven remote control using the SmartThings app	
Oven monitoring	<ul style="list-style-type: none">• Check the status of the oven
Oven Remote control	<ul style="list-style-type: none">• Set or adjust oven settings remotely. (Not available for Microwave mode)
My Cooking	<ul style="list-style-type: none">• Turn the oven off remotely.• Once cooking starts, change the set cooking time and temperature remotely.
Error Check	<ul style="list-style-type: none">• Automatically recognize errors.

NOTE

If  is not shown in the display, you are still able to monitor the oven status and turn the oven off

Cooking Smart

Manual cooking

Microwave cooking guide

- Do not use metal containers with Microwave mode. Always put food containers on the ceramic tray.
- It is recommended to cover the food for best results.
- After cooking is complete, let the food settle in its own steam.

Frozen vegetables

- Use a glass Pyrex container with a lid.
- Stir vegetables twice during cooking, and once after cooking.
- Add seasoning after cooking.

Food	Serving size (g)	Power (W)	Cooking time (min.)	Standing time (min.)
Spinach	150	600	5-6	2-3
	Add 15 ml (1 tbsp.) of cold water.			
Broccoli	300	600	8-9	2-3
	Add 30 ml (2 tbsp.) of cold water.			
Peas	300	600	7-8	2-3
	Add 15 ml (1 tbsp.) of cold water.			
Green Beans	300	600	7½-8½	2-3
	Add 30 ml (2 tbsp.) of cold water.			
Mixed Vegetables (Carrots/Peas/Corn)	300	600	7-8	2-3
	Add 15 ml (1 tbsp.) of cold water.			
Mixed Vegetables (Chinese Style)	300	600	7½-8½	2-3
	Add 15 ml (1 tbsp.) of cold water.			

Fresh vegetables

- Use a glass Pyrex container with a lid.
- Add 30-45 ml of cold water for every 250 g.
- Stir once during cooking, and once after cooking.
- Add seasoning after cooking.
- For faster cooking, it is recommended to cut into smaller, even sizes.
- Cook all fresh vegetables using full microwave power (800 W).

Food	Serving size (g)	Cooking time (min.)	Standing time (min.)
Broccoli	250	4-5	3
	500	5-6	
Brussels sprouts	250	5-6	3
	500	7-8	
Carrots	Add 60-75 ml (4-5 tbsp.) of water.		3
	250	5-6	
Cauliflower	Cut carrots into even sized slices.		3
	250	5-6	
Courgettes	Prepare even sized florets. Cut big florets into halves. Arrange stems to the centre.		3
	250	3-4	
Egg Plants	Cut courgettes into slices. Add 30 ml (2 tbsp.) of water or a knob of butter. Cook until just tender.		3
	250	3-4	
Leeks	Cut egg plants into small slices and sprinkle with 1 tablespoon lemon juice.		3
	250	3-4	
	Cut leeks into thick slices.		

Cooking Smart

Food	Serving size (g)	Cooking time (min.)	Standing time (min.)
Mushrooms	125	1-2	3
	250	2-3	
Prepare small whole or sliced mushrooms. Do not add any water. Sprinkle with lemon juice. Spice with salt and pepper. Drain before serving.			
Onions	250	4-5	3
Cut onions into slices or halves. Add only 15 ml (1 tbsp) water.			
Peppers	250	4-5	3
Cut pepper into small slices.			
Potatoes	250	4-5	3
	500	7-8	
Weigh the peeled potatoes and cut them into similar sized halves or quarters.			
Turnip cabbage	250	5-6	3
Cut turnip cabbage into small cubes.			

Rice and pasta

Stir from time to time during and after cooking.

Cook uncovered, and close the lid during settling. Then, drain water thoroughly.

- **Rice:** Use a large glass Pyrex container with a lid against the rice doubling in volume.
- **Pasta:** Use a large glass Pyrex container.

Food	Serving size (g)	Power (W)	Cooking time (min.)	Standing time (min.)	Directions
White rice (parboiled)	250	800	17-18	5	Add 500 ml of cold water.
	375		18-20		Add 750 ml of cold water.
Brown rice (parboiled)	250	800	20-22	5	Add 500 ml of cold water.
	375		22-24		Add 750 ml of cold water.
Mixed rice (rice + wild rice)	250	800	17-19	5	Add 500 ml of cold water.
Mixed corn (rice + grain)	250	800	18-20	5	Add 400 ml of cold water.
Pasta	250	800	10-11	5	Add 1000 ml of hot water.

Reheating

- Do not reheat large-sized foods such as joints of meat, which easily overcook.
- It is safer to reheat foods at lower power levels.
- Stir well or turn over during and after cooking.
- Use caution for liquids or baby foods. Stir well before, during, and after cooking with a plastic spoon or glass stirring stick to prevent eruptive boiling and scalding. Keep them inside the oven during the standing time. Allow a longer reheating time than other food types.
- Recommended standing time after reheating is 2-4 minutes. See the table below for reference.

Liquids and food

Food	Serving size	Power (W)	Cooking time (min.)	Standing time (min.)
Drink	250 ml (1 mug)	800	1½-2	1-2
	500 ml (2 mugs)		2-3	
Pour into a ceramic cup and reheat uncovered. Place cup in the center of ceramic tray. Stir carefully before and after standing time.				
Soup (Chilled)	250 g	800	3-4	2-3
	Pour into a deep ceramic plate. Cover with plastic lid. Stir well after reheating. Stir again before serving.			
Stew (Chilled)	350 g	600	5-6	2-3
	Pour into a deep ceramic plate. Cover with plastic lid. Stir well after reheating. Stir again before serving.			
Pasta with sauce (Chilled)	350 g	600	5-6	2-3
	Pour into a deep ceramic plate. Cover with plastic lid. Stir well after reheating. Stir again before serving.			
Plated meal (Chilled)	350 g	600	5-6	3
	450 g		6-7	
Plate a meal of 2-3 chilled components on a ceramic dish. Cover with microwave cling film.				

Baby foods & milk

Food	Serving size	Power (W)	Cooking time (sec.)	Standing time (min.)
Baby Food (Vegetable + Meat)	190 g	600	30-40	2-3
	Empty into ceramic deep plate. Cook covered. Stir after cooking time. Stand for 2-3 minutes. Before serving, stir well and check the temperature carefully.			
Baby Porridge (Grain + Milk + Fruit)	190 g	600	20-30	2-3
	Empty into ceramic deep plate. Cook covered. Stir after cooking time. Stand for 2-3 minutes. Before serving, stir well and check the temperature carefully.			
Baby Milk	100 ml	300	30-40	2-3
	200 ml		50-60	
Stir or Shake well and pour into a sterilized glass bottle. Place into the centre of ceramic tray. Cook uncovered. Shake well and stand for at least 3 minutes. Before serving, Shake well and check the temperature carefully.				

Cooking Smart

Defrost

Put frozen food in a microwave-safe container without a cover. Turn over during defrosting, and drain off liquid and remove giblets after defrosting. For faster defrosting, cut the food into small pieces, and wrap them with aluminum foil before defrosting. When the outer surface of frozen foods begins to melt, stop defrosting and let stand as instructed in the table below.

Do not change the default power level (180 W) for defrosting.

Food	Serving size (g)	Defrosting time (min.)	Standing time (min.)
Meat	Minced meat	6-7	15-30
		8-12	
	Pork steaks	7-8	
Place the meat on the ceramic plate. Shield thinner edges with aluminium foil. Turn over after half of defrosting time.			
Poultry	Chicken pieces	12-14	15-60
	Whole chicken	28-32	
First, put chicken pieces skin - side down, whole chicken breast - side - down on ceramic plate. Shield the thinner parts like wings and ends with aluminium foil. Turn over after half of defrosting time.			
Fish	Fish fillets	6-7	10-25
	Whole fish	11-13	
Put frozen fish in the middle of ceramic plate. Arrange the thinner parts under the thicker parts. Shield narrow ends of fillets and tail of whole fish With aluminium foil. Turn over after half of defrosting time.			
Fruit	Berries	6-7	5-10
	Spread fruit on a flat, round glass dish with a large diameter.		

Bread	Food	Serving size (g)	Defrosting time (min.)	Standing time (min.)
	Bread rolls (each ca. 50 g)	2 pcs	1-1½	5-20
	Toast/sandwich	4 pcs	2½-3	
		250	4-4½	
		500	7-9	
Arrange rolls in a circle or bread horizontally on kitchen paper on the ceramic plate. Turn over after half of defrosting time.				

Grilling guide

The grill-heating elements are located on the ceiling of the cooking chamber.

These elements operate only when the door is closed.

When grilling food, put the food on the high rack unless otherwise instructed.

Preheat the grill for 2-3 minutes with Grill mode, and, unless otherwise instructed below, grill food on the high rack. When grilling is complete, use oven gloves to take out the food.

Cookware

Grill and Fan grill: Use flameproof containers, which may include metal parts.

Do not use plastic cookware of any kind.

Microwave + Grill: Do not use cookware that is made of metal or plastic substances.

Food type

Chops, sausages, steaks, hamburgers, bacon and gammon rashers, thin fish portions, sandwiches, and all kinds of toast with toppings.

Grilling

Set 220 °C grill temperature, preheat for 5 minutes.

Food	Accessory	Level	Cooking time (1 st side) (min.)	Cooking time (2 nd side) (min.)
Kebab spits	Wire tray insert + Ceramic Tray	5	8-10	6-8
Pork steaks	Wire tray insert + Ceramic Tray	5	7-9	5-7
Sausages	Wire tray insert + Ceramic Tray	5	6-8	6-8
Chicken pieces	Wire tray insert + Ceramic Tray	5	20-25	15-20
Salmon steaks	Wire tray insert + Ceramic Tray	5	8-12	6-10
Sliced vegetables	Wire tray insert + Ceramic Tray	5	15-20	-
Toast	Wire tray insert + Ceramic Tray	5	2-3	1-2
Cheese toasts	Wire tray insert + Ceramic Tray	5	3-5	-

Fan Grill

Set the temperature in this table and preheat for 5 minutes.

Food	Temp. (°C)	Accessory	Level	Cooking time (1 st side) (min.)	Cooking time (2 nd side) (min.)
Potato wedges	200-220	Baking tray	4	25-30	-
Frozen croquettes	210-220	Baking tray	4	15-20	-
Frozen chicken nuggets	210-220	Baking tray	4	15-20	-
Whole fish	200-220	Wire tray insert + Ceramic tray	4	10-15	10-15
Chicken pieces	200-210	Wire tray insert + Ceramic tray	4	20-25	15-20
Whole chicken	200-210	Wire tray insert + Ceramic tray	3	30-35	25-30

Cooking Smart

Microwave + Grill

Food	Power level (W)	Temp. (°C)	Accessory	Level	Cooking time (1 st side) (min.)	Cooking time (2 nd side) (min.)
Baked potatoes	1st: 450 2nd: -	1st: 180-200 2nd: 220	Wire tray insert + Ceramic Tray	4	10-15	2-4
Grilled tomatoes	180	160-180	Wire tray insert + Ceramic Tray	4	10-15	-
Vegetable gratin	450	180-200	Wire tray insert + Ceramic Tray	4	10-15	-
Roast fish	300	180-200	Wire tray insert + Ceramic Tray	4	5-8	6-10
Chicken pieces	300	180-200	Wire tray insert + Ceramic Tray	4	13-17	13-17

Convection guide

Convection and Fan conventional

Convection mode and Fan conventional mode, both the heating element and the side-wall fan operate together to circulate the heat inside the cooking chamber. All conventional ovenproof cookware, baking tins and sheets - anything you would normally use in a traditional convection oven - can be used.

Microwave + Convection

This combination mode combines the microwave energy with hot air, resulting in reduced cooking time and producing a brown, crispy surface of the food. The oven offers 5 different combination modes for your convenience. Use this for all kinds of meat and poultry as well as casseroles and gratin dishes, sponge cakes and light fruit cakes, pies and crumbles, roast vegetables, scones, and breads. Use only ovenproof cookware, such as glasses, potteries, or bone china without metal trim.

Convection

Preheat the oven with Convection mode.

Food	Temp. (°C)	Accessory	Level	Cooking time (min.)
Hazelnut cake square mould	160-170	Wire tray insert + Ceramic Tray	2	60-70
Lemon cake ring-shaped or bowl mould	150-160	Wire tray insert + Ceramic Tray	2	50-60
Sponge cake	150-160	Wire tray insert + Ceramic Tray	2	25-35
Fruit flan base	150-170	Wire tray insert + Ceramic Tray	2	25-35
Flat streusel fruit cake (yeast dough)	150-170	Baking tray	3	30-40
Croissants	170-180	Baking tray	2	10-15
Bread rolls	180-190	Baking tray	2	10-15
Cookies	160-180	Baking tray	3	10-20
Oven chips	200-220	Baking tray	3	15-20

Fan Conventional

Use temperatures and times in this table as guidelines for baking. We recommend to preheat the oven with Fan Conventional mode.

Food	Temp. (°C)	Accessory	Level	Cooking time (min.)
Lasagna	180-190	Baking tray	3	25-30
Potato Gratin	170-180	Baking tray	2	45-50
Sponge Cake	150-160	Baking tray	2	35-40
Loaf cake	150-160	Baking tray	2	50-60
White bread	170-180	Baking tray	2	20-25
Homemade Pizza	180-200	Baking tray	2	20-30
Frozen self-rising Pizza	180-200	Baking tray	2	15-20
Quiche Lorraine	180-190	Baking tray	2	40-50
Apple Pie	160-170	Baking tray	2	60-80
Puff Pastry, Apple filling	180-190	Baking tray	3	15-20

Microwave + Convection

Food	Power level (W)	Temp. (°C)	Accessory	Level	Cooking time (1 st side) (min.)	Cooking time (2 nd side) (min.)
Whole chicken 1.2 kg	1st: 450 2nd: 300	180-200	Wire tray insert + Ceramic Tray	3	20-25	23-27
Roast beef / Lamb (Medium)	300	180-200	Wire tray insert + Ceramic Tray	3	17-22	18-25
Frozen lasagne / Pasta gratin	450	180-200	Wire tray insert + Ceramic Tray	3	30-35	-
Potato gratin	450	180-200	Wire tray insert + Ceramic Tray	3	15-20	-
Fresh fruit flan	100	160-180	Ceramic Tray	3	45-50	-

Cooking Smart

Quick & Easy

Melting butter

Put 50 g butter into a small deep glass dish. Cover with plastic lid. Heat for 30-40 seconds using 800 W, until butter is melted.

Melting chocolate

Put 100 g chocolate into a small deep glass dish. Heat for 3-5 minutes, using 450 W until chocolate is melted. Stir once or twice during melting. Use oven gloves while taking out!

Melting crystallized honey

Put 20 g crystallized honey into a small deep glass dish. Heat for 20-30 seconds using 300 W, until honey is melted.

Melting gelatine

Lay dry gelatine sheets (10 g) for 5 minutes into cold water. Put drained gelatine into a small glass pyrex bowl. Heat for 1 minute using 300 W. Stir after melting.

Cooking glaze/icing (for cake and gateaux)

Mix instant glaze (approximately 14 g) with 40 g sugar and 250 ml cold water. Cook uncovered in a glass pyrex bowl for 3½ to 4½ minutes using 800 W, until glaze/icing is transparent. Stir twice during cooking.

Cooking jam

Put 600 g fruits (for example mixed berries) in a suitable sized glass pyrex bowl with lid. Add 300 g preserving sugar and stir well. Cook covered for 10-12 minutes using 800 W. Stir several times during cooking. Put directly into small jam glasses with twist-off lids. Stand on lid for 5 minutes.

Cooking pudding

Mix pudding powder with sugar and milk (500 ml) by following the manufacturers instructions and stir well. Use a suitable sized glass pyrex bowl with lid. Cook covered for 6½ to 7½ minutes using 800 W. Stir several times well during cooking.

Browning almond slices

Spread 30 g sliced almonds evenly on a medium sized ceramic plate. Stir several times during browning for 3½ to 4½ minutes using 600 W. Let it stand for 2-3 minutes in the oven. Use oven gloves while taking out!

Troubleshooting

You may encounter a problem using the oven. In that case, first check the table below and try the suggestions. If a problem persists, or if any information code keeps appearing on the display, contact a local Samsung service centre.

Checkpoints

If you encounter a problem with the oven, first check the table below and try the suggestions.

Problem	Cause	Action
General		
The buttons cannot be pressed properly.	Foreign matter may be caught between the buttons.	Remove the foreign matter and try again.
	For touch models: Moisture is on the exterior.	Wipe the moisture from the exterior.
	Child lock is activated.	Deactivate Child lock.
The time is not displayed.	Power is not supplied.	Make sure power is supplied.
	The Eco (power-saving) function is set.	Turn off the Eco function.
The oven does not work.	Power is not supplied.	Make sure power is supplied.
	The door is open.	Close the door and try again.
The oven stops while in operation.	The door open safety mechanisms are covered in foreign matter.	Remove the foreign matter and try again.
	The user has opened the door to turn food over.	After turning over the food, press the  button again to start operation.

Problem	Cause	Action
The power turns off during operation.	The oven has been cooking for an extended period of time.	After cooking for an extended period of time, let the oven cool.
	The cooling fan is not working.	Listen for the sound of the cooling fan.
	Trying to operate the oven without food inside.	Put food in the oven.
	There is not sufficient ventilation space for the oven.	There are intake/exhaust outlets on the front and rear of the oven for ventilation. Keep the gaps specified in the product installation guide.
There is no power to the oven.	Several power plugs are being used in the same socket.	Designate only one socket to be used for the oven.
	Power is not supplied.	Make sure power is supplied.
There is a popping sound during operation, and the oven doesn't work.	Cooking sealed food or using a container with a lid may cause popping sounds.	Do not use sealed containers as they may burst during cooking due to expansion of the contents.

Problem	Cause	Action
The oven exterior is too hot during operation.	There is not sufficient ventilation space for the oven.	There are intake/exhaust outlets on the front and rear of the oven for ventilation. Keep the gaps specified in the product installation guide.
	Objects are on top of the oven.	Remove all objects on the top of the oven.
The door cannot be opened properly.	Food residue is stuck between the door and oven interior.	Clean the oven and then open the door.
The oven does not heat.	The oven may not work, too much food is being cooked, or improper cookware is being used.	Put one cup of water in a microwave-safe container and run the microwave for 1-2 minutes to check whether the water is heated. Reduce the amount of food and start the function again. Use a cooking container with a flat bottom.

Troubleshooting

Problem	Cause	Action
Heating is weak or slow.	The oven may not work, too much food is being cooked, or improper cookware is being used.	Put one cup of water in a microwave-safe container and run the microwave for 1-2 minutes to check whether the water is heated. Reduce the amount of food and start the function again. Use a cooking container with a flat bottom.
The warm function does not work.	The oven may not work, too much food is being cooked, or improper cookware is being used.	Put one cup of water in a microwave-safe container and run the microwave for 1-2 minutes to check whether the water is heated. Reduce the amount of food and start the function again. Use a cooking container with a flat bottom.

Problem	Cause	Action
The thaw function does not work.	The oven may not work, too much food is being cooked, or improper cookware is being used.	Put one cup of water in a microwave-safe container and run the microwave for 1-2 minutes to check whether the water is heated. Reduce the amount of food and start the function again. Use a cooking container with a flat bottom.
The interior light is dim or does not turn on.	The door has been left open for a long time. The interior light is covered by foreign matter.	The interior light may automatically turn off when the Eco function operates. Close and reopen the door or press the "Back" button. Clean the inside of the oven and check again.
A beeping sound occurs during cooking.	If the Auto Cook function is being used, this beeping sound means it's time to turn over the food during thawing.	After turning over the food, press the Start button again to restart operation.
The oven is not level.	The oven is installed on an uneven surface.	Make sure the oven is installed on flat, stable surface.

Problem	Cause	Action
There are sparks during cooking.	Metal containers are used during the oven/thawing functions.	Do not use metal containers.
When power is connected, the oven immediately starts to work.	The door is not properly closed.	Close the door and check again.
There is electricity coming from the oven.	The power or power socket is not properly grounded.	Make sure the power and power socket are properly grounded.
There is water dripping.	There may be water or steam in some cases depending on the food. This is not an oven malfunction.	Let the oven cool and then wipe with a dry dish towel.
Steam leaks from the door.	There may be water or steam in some cases depending on the food. This is not an oven malfunction.	Let the oven cool and then wipe with a dry dish towel.
There is water left in the oven.	There may be water or steam in some cases depending on the food. This is not an oven malfunction.	Let the oven cool and then wipe with a dry dish towel.

Problem	Cause	Action
The brightness inside the oven varies.	Brightness changes depending on power output changes according to function.	Power output changes during cooking are not malfunctions. This is not an oven malfunction.
Cooking is finished, but the cooling fan is still running.	To ventilate the oven, the cooling fan continues to run for about 5 minutes after cooking is complete.	This is not an oven malfunction.
Pressing the +30 secs button operates the oven.	This happens when the oven was not operating.	The microwave oven is designed to operate by pressing the +30 secs button when it was not operating.

Troubleshooting

Problem	Cause	Action
Grill		
Smoke comes out during operation.	During initial operation, smoke may come from the heating elements when you first use the oven.	This is not a malfunction, and if you run the oven 2-3 times, it should stop.
	Food is on the heating elements.	Let the oven cool and then remove the food from the heating elements.
	Food is too close to the grill.	Put the food a suitable distance away while cooking.
	Food is not properly prepared and/or arranged.	Make sure food is properly prepared and arranged.
Oven		
The oven does not heat.	The door is open.	Close the door and try again.
Smoke comes out during preheating.	During initial operation, smoke may come from the heating elements when you first use the oven.	This is not a malfunction, and if you run the oven 2-3 times, it should stop.
	Food is on the heating elements.	Let the oven cool and then remove the food from the heating elements.
There is a burning or plastic smell when using the oven.	Plastic or non heat-resistant cookware is used.	Use glass cookware suitable for high temperatures.

Problem	Cause	Action
There is a bad smell coming from inside the oven.	Food residue or plastic has melted and stuck to the interior.	Use the steam function and then wipe with a dry cloth. You can put a lemon slice inside and run the oven to remove the odour more quickly.
	The oven door is frequently opened during cooking.	Do not frequently open the door unless you are cooking things that need to be turned. If you open the door often, the interior temperature will be lowered and this may affect the results of your cooking.
The oven does not cook properly.	The oven controls are not correctly set.	Correctly set the oven controls and try again.
	The grill or other accessories are not correctly inserted.	Correctly insert the accessories.
	The wrong type or size of cookware is used.	Reset the oven controls or use suitable cookware with flat bottoms.

Technical specifications

SAMSUNG strives to improve its products at all times. Both the design specifications and these user instructions are thus subject to change without notice.

Power Source		230 V ~ 50 Hz
Power Consumption	Maximum power	2700 W
	Microwave	1600 W
	Grill	2600 W
	Convection	2600 W
Output Power		100 W / 800 W (IEC - 705)
Operating Frequency		2450 MHz
Magnetron		OM75P (21)
Cooling Method		Cooling fan motor
Dimensions (W x H x D)	Main unit	595 x 456 x 570 mm
	Built-in	560 x 446 x 549 mm
Volume		50 liter
Weight	Net	38.8 Kg
	Shipping	45.6 Kg

* This product contains a light source of energy efficiency class <G>.

Information codes

If the oven fails to operate, you may see an information code on the display. Check the table below and try the suggestions.

Code	Description	Action
C-20	The temperature sensor is open.	Unplug the power cord of the oven, and contact a local Samsung service centre.
C-F0	The temperature sensor is short.	
C-F1	If there is no communication between the main and sub MICOM. Only occurs when EEPROM Read or Write is not working.	
C-21	This code appears when the oven temperature high. In case the temperature rises over the limit temperature during operation of each mode. (Fire sensed.)	Unplug the power cord for cooling enough time, and restart the microwave oven.
C-F2		Stop the oven and then try again.
C-d0	The touch key is malfunction.	Unplug the power cord for cooling enough time, and clean the button. (Dust, Water) When appear same problem, contact a local Samsung service centre.

Appendix

Overall Standby Power consumption (W) (All network ports is "on" condition)	1.9 W
Period of time for the power management (min)	20 min.
WiFi	1.9 W
Standby-mode Power Consumption (W)	20 min.
Period of time for the power management (min)	0.5 W
Off mode	30 min.
Power consumption	
Period of time for the power management (min)	

Data determined according to standard EN 50564 and Regulation (EC) No 1275/2008.

NOTE

Hereby, Samsung declares that this radio equipment is in compliance with Directive 2014/53/EU and with the relevant statutory requirements in the UK. The full text of the EU declaration of conformity and the UK declaration of conformity is available at the following internet address: The official Declaration of conformity may be found at <http://www.samsung.com.go> to Support > Search Product Support and enter the model name.

	Frequency range	Transmitter power (Max)
Wi-Fi	2401-2495 MHz	20 dBm
Bluetooth	2402-2480 MHz	10 dBm

Open Source Announcement

The software included in this product contains open source software. The following URL http://opensource.samsung.com/opensource/SMART_TP1_0/seq/0 leads to open source license information as related to this product.



Memo



Please be advised that the Samsung warranty does NOT cover service calls to explain product operation, correct improper installation, or perform normal cleaning or maintenance.

QUESTIONS OR COMMENTS?

COUNTRY	CALL	OR VISIT US ONLINE AT
AUSTRIA	0800 72 67 864 (0800-SAMSUNG)	www.samsung.com/at/support
BELGIUM	02-201-24-18	www.samsung.com/be/support (Dutch) www.samsung.com/be_fr/support (French)
DENMARK	707 019 70	www.samsung.com/dk/support
FINLAND	030-6227 515	www.samsung.com/fi/support
FRANCE	01 48 63 00 00	www.samsung.com/fr/support
GERMANY	06196 77 555 77	www.samsung.com/de/support
ITALIA	800-SAMSUNG (800.7267864)	www.samsung.com/it/support
CYPRUS	8009 4000 only from landline, toll free	www.samsung.com/gr/support
GREECE	80111-SAMSUNG (80111 726 7864) only from land line (+30) 210 6897691 from mobile and land line	www.samsung.com/gr/support
LUXEMBURG	261 03 710	www.samsung.com/be_fr/support
NETHERLANDS	088 90 90 100	www.samsung.com/nl/support
NORWAY	21629099	www.samsung.com/no/support
PORTUGAL	210 608 098 Chamada para a rede fixa nacional Dias úteis das 9h às 20h	www.samsung.com/pt/support
SPAIN	91 175 00 15	www.samsung.com/es/support
SWEDEN	0771-400 300	www.samsung.com/se/support
SWITZERLAND	0800 726 786	www.samsung.com/ch/support (German) www.samsung.com/ch_fr/support (French)
UK	0333 000 0333	www.samsung.com/uk/support

COUNTRY	CALL	OR VISIT US ONLINE AT
IRELAND (EIRE)	0818 717100	www.samsung.com/ie/support
ALBANIA	045 620 202	www.samsung.com/al/support
BOSNIA	055 233 999	www.samsung.com/ba/support
NORTH MACEDONIA	023 207 777	www.samsung.com/mk/support
BULGARIA	0800 111 31 - Безплатен за всички оператори *3000 - Цена на един градски разговор или според тарифата на мобилният оператор 09:00 до 18:00 - Понеделник до Петък	www.samsung.com/bg/support
CROATIA	072 726 786	www.samsung.com/hr/support
CZECH	800 - SAMSUNG (800-726786)	www.samsung.com/cz/support
HUNGARY	0680SAMSUNG (0680-726-7864)	www.samsung.com/hu/support
MONTENEGRO	020 405 888	www.samsung.com/su/support
POLAND	801-172-678* lub +48 22 607-93-33* * (opłata według taryfy operatora)	http://www.samsung.com/pl/support/
ROMANIA	0800872678 - Apel gratuit *8000 - Apel tarifat în rețea	www.samsung.com/ro/support
SERBIA	011 321 6899	www.samsung.com/rs/support
SLOVAKIA	0800 - SAMSUNG (0800-726 786)	www.samsung.com/sk/support
LITHUANIA	8-800-77777	www.samsung.com/lt/support
LATVIA	8000-7267	www.samsung.com/lv/support
ESTONIA	800-7267	www.samsung.com/ee/support
SLOVENIA	080 697 267 (brezplačna številka)	www.samsung.com/si/support
KOSOVO	038 40 30 90	www.samsung.com/su/support

