

**Accento A 40IF/12**
[> Web link](#)

**Fitting style**  
Flushmount sinks / Flat-mount inset

**Model**  
A 40IF/12

**Material**  
Stainless steel 18/10

**Article no.**  
10.104.536.00

**Cabinet size**  
45 cm

**Basket**  
3½" Tipo

**Surface**  
Polished

**Price CHF**  
1'318.- excl. VAT

**Dimensions**  
400x400x175mm

**Corner radius**  
12 mm

**Overflow and drain technology**
**Overflow and drain technology**

Sieve - type S



Swivelling overflow cap

**Prices (as of 26.06.26/excl. VAT)**

Model	Material	Basket	Article no.	Price CHF
Accento A 40IF/12	Stainless steel 18/10, Polished	3½" Tipo	10.104.536.00	1'318.- <a href="#">&gt; Weblink</a>

**Accessory**

## Optional accessories



[> Weblink](#)  
40.000.912.00 / CHF 106.-  
Colander, perforated



[> Weblink](#)  
40.001.289.00 / CHF 106.-  
Colander, unperforated

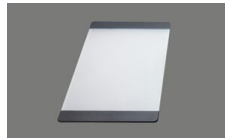

[> Weblink](#)  
40.000.909.00 / CHF 151.-  
Chopping board, made of glass, white



[> Weblink](#)  
40.001.277.00 / CHF 151.-  
Chopping board, made of plastic

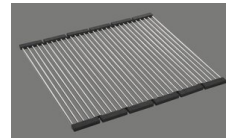

[> Weblink](#)  
40.001.138.00 / CHF 125.-  
Inox Pad

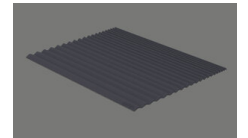

[> Weblink](#)  
40.002.008.00 / CHF 51.-  
Maro dish drainer mat, Dark Grey

# Accento A 40IF/12 sFlow Typ S

Randbreite 12mm  
 Bord de 12mm de largeur  
 Larghezza bordo 12mm

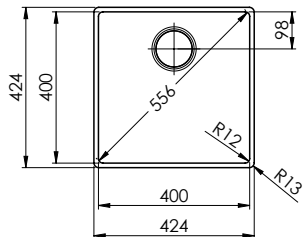

Für 12mm Arbeitsplatte.  
 Pour plan de travail de 12mm.  
 Per piano di lavoro da 12mm.

X (1:2)

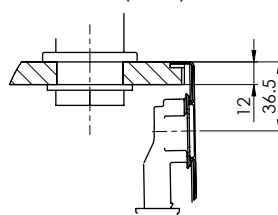

Y (1:2)

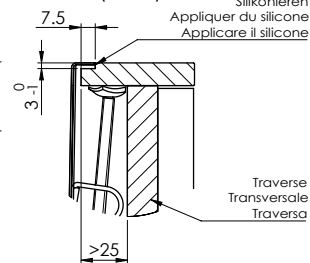

Für 13 - 30mm Arbeitsplatte.  
 Pour plan de travail de 13 - 30mm.  
 Per piano di lavoro da 13 - 30mm.

X (1:2)

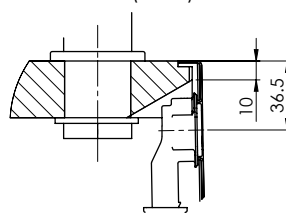

Y (1:2)

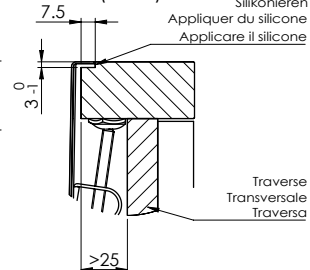

Für 13 - 50mm Arbeitsplatte.  
 Pour plan de travail de 13 - 50mm.  
 Per piano di lavoro da 13 - 50mm.

X (1:2)

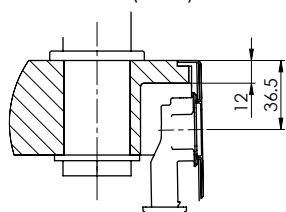

Y (1:2)

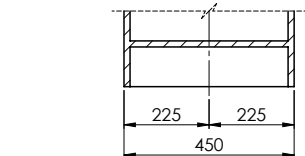
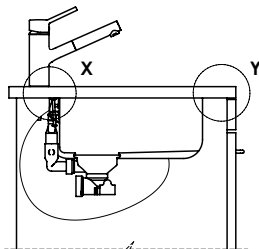
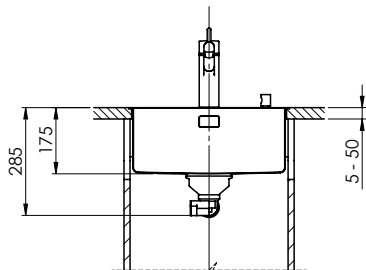
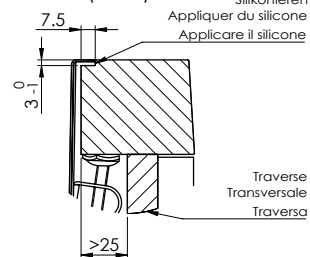

Bei der Planung die Traverse im Möbel beachten!

Faites attention à la barre transversale dans les meubles lors de la planification!

Presta attenzione alla traversa nei mobili durante la pianificazione!

Vom flächenbündigen Einbau in beschichteten Spanplatten raten wir ab.  
 Nous vous déconseillons le montage à fleur sur des panneaux de particules enduits.  
 Sconsigliamo il montaggio a filo top in pannelli di truciolato laminato.

# Accento A 40IF/12 sFlow Typ S

**Ausschnitt für flächenbündigen Einbau - Randbreite 12mm:**  
**Mesure de coupe pour montage à fleur - Bord de 12mm de largeur:**  
**Intaglio per montaggio a filo top - Larghezza bordo 12mm:**

Bohrung für Zug- und Druckknöpfe ø14  
 Bohrung für Drehknopf ø25

Trou pour boutons et Pousoirs de commande ø14  
 Trou pour bouton rotatif ø25

Foro per Pomelli tiranti e Pomelli pulsanti ø14  
 Foro per Pomolo girevoli ø25

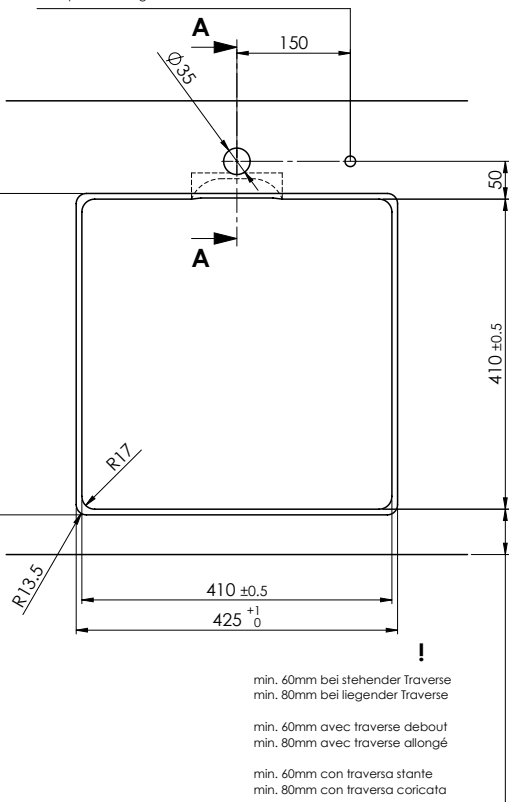

Für 12mm Arbeitsplatte.  
 Pour plan de travail de 12 mm.  
 Per piano di lavoro da 12 mm.

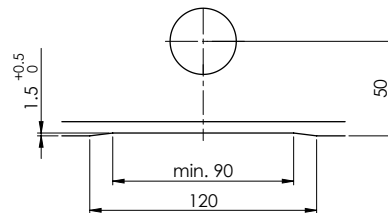

Für 13 - 30mm Arbeitsplatte.  
 Pour plan de travail de 13 - 30mm.  
 Per piano di lavoro da 13 - 30mm.

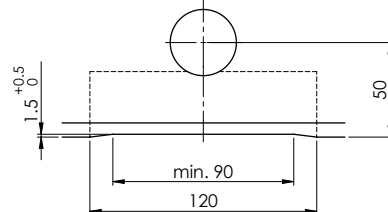

Für 13 - 50mm Arbeitsplatte.  
 Pour plan de travail de 13 - 50mm.  
 Per piano di lavoro da 13 - 50mm.

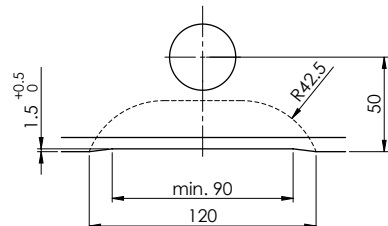

# Accento A 40IF/12 sFlow Typ S

**Ausschnitt für flach aufliegender Einbau - Randbreite 12mm:**  
**Mesure de coupeure pour montage en appui - Bord de 12mm de largeur:**  
**Intaglio per montaggio soprapiano - Larghezza bordo 12mm:**

Bohrung für Zug- und Druckknöpfe ø14  
 Bohrung für Drehknopf ø25

Trou pour boutons et Pouissoirs de commande ø14  
 Trou pour bouton rotatif ø25

Foro per Pomelli tiranti e Pomelli pulsanti ø14  
 Foro per Pomolo girevoli ø25

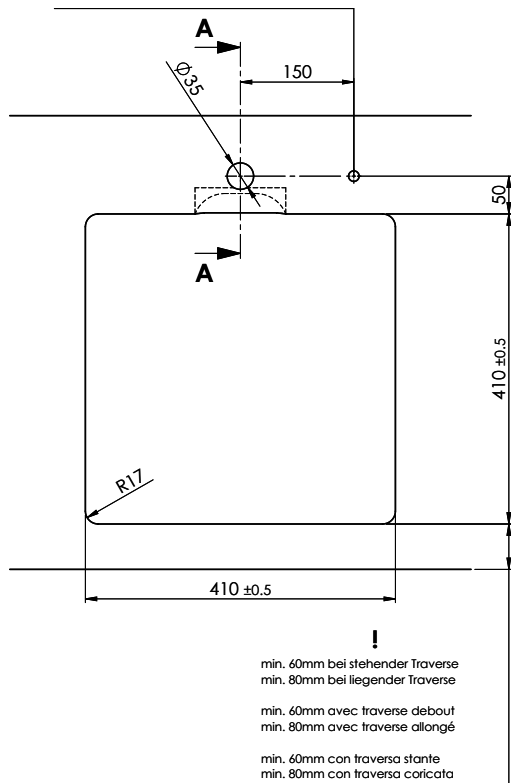

Für 12mm Arbeitsplatte.  
 Pour plan de travail de 12 mm.  
 Per piano di lavoro da 12 mm.

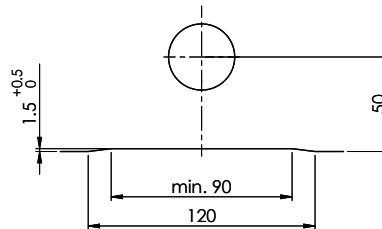

A-A (1 : 2)

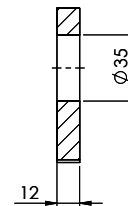

Für 13 - 30mm Arbeitsplatte.  
 Pour plan de travail de 13 - 30mm.  
 Per piano di lavoro da 13 - 30mm.

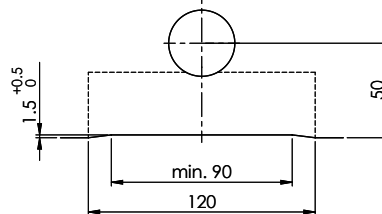

A-A (1 : 2)

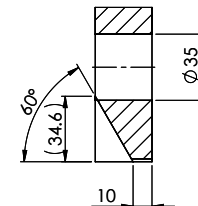

Für 13 - 50mm Arbeitsplatte.  
 Pour plan de travail de 13 - 50mm.  
 Per piano di lavoro da 13 - 50mm.

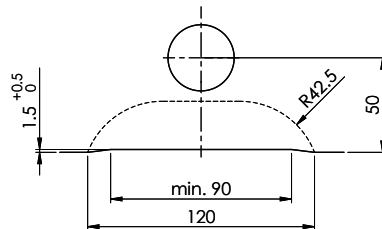

A-A (1 : 2)

