

## Samsung Built-in refrigerator &amp; freezer combination EKG130 (left)

[> Web link](#)

**Model**  
Samsung Built-in refrigerator & freezer combination  
EKG130 (left)

**Energy efficiency class**  
E (New Label 03.21)

**Manufacturer ID**  
BRB26612EWW/WS

**Article no.**  
500.000.153.00

**Door hinge**  
Left

**Construction**  
Euro Norm 60 cm

**VRG**  
26.00

**Price CHF**  
1'791.- excl. VAT

## Highlights

- Digital Inverter compressor - 10-year warranty
- NoFrost+ technology in refrigerator and freezer - the end of de-icing
- Precise Cooling - for maximum temperature accuracy
- All Around Cooling - consistent temperature in the cooling chamber
- Power Freeze - accelerates the freezing process
- 3 glass shelves, 1 Rack & Shelf
- 1 vegetable drawer
- 267 litres useable capacity

## Product description

Samsung Built-in Refrigerator and Freezer EKG130  
Construction: **Euro Norm 60 cm**  
GTIN-Nr.: **8806092211186**

**Model classification**

Energy efficiency class (from A to G): **E**  
Efficiency index: **100**  
Energy consumption per year: **231 kWh**

**Design**

Colour/material: **White**  
Door handles: -

**Display and operation**

Display: **Digital display**  
Display and lighting: **LED, ice blue**  
Operation: **Touch LCD**

**Interconnection of household appliances**

Samsung Smart Home: -

**Performance properties**

**Total useable capacity: 267 L**  
Of which NoFrost: **267 L**  
**Useable capacity refrigerator: 193 L**  
Of which cellar refrigeration max./min.: -  
Of which cold storage compartment: -  
**Useable capacity freezer: 74 L**  
Freezing capacity: **6 kg in 24 hours**  
Storage time in case of outage: **6 hours**  
Sound power level: **35 dB(A)**  
Airborne sound emission class : **B**  
Climate class: **SN-T**  
Ambient temperature (min. > max.): **von +10°C bis +43°C**  
De-icing process refrigerator: **Automatic**  
De-icing process freezer: **Automatic**

**Construction and identification**

Stand-alone unit: -  
Built-in unit: **Yes**  
Undermount unit: -  
Integral: **Yes**  
Number of outside doors/pull-outs: **2/-**  
Door hinge: **Left (reversible)**

**Dimensions**

Height:

**Samsung Built-in refrigerator & freezer combination EKG130 (left)**[> Web link](#)**177,5 cm**Width: **54,0 cm**Depth: **55,0 cm**Width with open door/pull-out: **70 cm**Depth with open door/pull-out: **112 cm**Dimensions of unit (H x W x D) : **1775 x 540 x 550 mm****Empty weight**Unit weight: **62 kg****Fittings****Adjustable freezer temperature**Independent of refrigerator temperature: **Yes**

Together with refrigerator temperature: -

Control for continuous freezer operation: -

**Control indicators refrigerator**Regular operation: **Lamp**Temperature indicator: **Inside**Door open: **Acoustic after 120 sec.****Control indicators freezer**Regular operation: **Lamp**Continuous operation: **Lamp**Malfunction / warning signal: **visual / acoustic**Door open: **warning signal, acoustic**Temperature indicator: **inside****Refrigerator**Egg trays: **6**

Door compartments with flap or sliding door: -

Door shelves and/or containers: **4**Refrigerator storage surfaces: **5**- - of which adjustable: **2**Refrigerator containers: **1****Freezer**

Door compartments: -

Interior compartments: **1**Baskets, containers, interior drawers: **2**Ice cube trays: **Yes****Additional fittings**

Door water and ice dispenser: -

ClearView ice maker: -

Water filter: -

Interior lighting / energy efficiency class: **LED / G**Fruit and vegetable compartments: **1**

Fresh Zone compartments: -

Pull-out tray: **1**Wine cooler: **Yes / 5 bottles**

Water connection: -

**Cooling technology**Digital inverter compressor: **Yes**NoFrost+ technology: **Yes**Power Freeze: **Yes**

Cool Select Plus: -

All Around Cooling (multi-flow): **Yes**

Metal Cooling: -

Twin Cooling Plus: -

Precise Cooling: **Yes**

Flex zone: -

Refrigerant: **R-600a****Power and water supply****Electrical connection**Supply voltage: **230 V**Frequency: **50 Hz**Connection values: **160 W**Fuse protection: **1,4 A**Length power connection: **2.5 m**Power plug **Plug type 12, 10 A****Water connection**

Water connection: -

Pressure hose G 3/4": -

Connectable to: -

Connectable to cold/hot water: -

Water pressure: -

Water inlet: -

Water outlet: -

**Technical data**

Standard width:

## Samsung Built-in refrigerator & freezer combination EKG130 (left)

[> Web link](#)

### Euro Norm 60 cm

Standard height: -

Niche height: **1778 - 1782 mm**

Niche width: **555 - 568 mm**

Niche depth: **min. 560 mm**

Niche dimensions (H x W x D): **1778 - 1782 x 555 - 568 x min. 560 mm**

Max. door front weight refrigerator/freezer: **18 kg / 12 kg**

Assembly technology: **Fixed door assembly**

Unit height: **1775 mm**

Unit width: **540 mm**

Unit depth: **550 mm**

### Packaging

Weight, incl. packaging: **64.0 kg**

Packaging dimensions (H x W x D): **1864 x 600 x 629 mm**

## Accessory

### Optional accessories

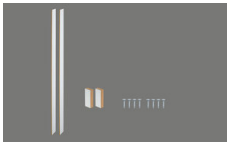

[> Weblink](#)

500.000.089.00 / CHF  
112.-

Mounting kit EKG130 +  
EKG220 16 mm

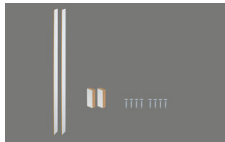

[> Weblink](#)

500.000.090.00 / CHF  
112.-

Mounting kit EKG130 +  
EKG220 19 mm

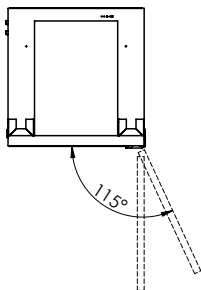
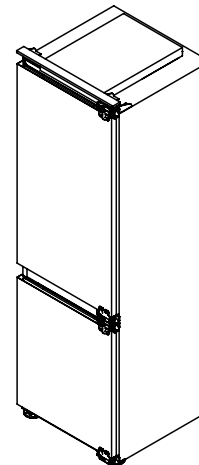
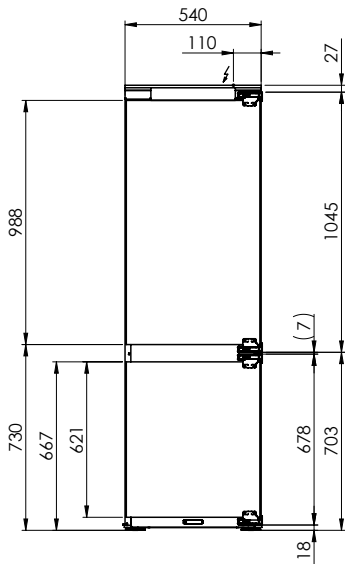

 EKG130: 230 V / 10 A, T12, 2500 mm

Für diese Zeichnung sind alle Rechte vorbehalten. Dieses Dokument enthält alle Rechte und ist das geistige Eigentum der Suter Inox AG. Alle Rechte vorbehalten. Ohne schriftliche Genehmigung der Suter Inox AG ist die Verwendung dieses Dokuments für andere Zwecke nicht zulässig. © Copyright 2005 Suter Inox AG. All rights reserved.

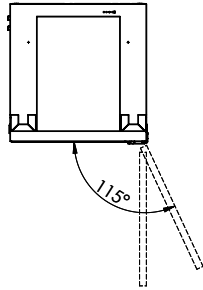
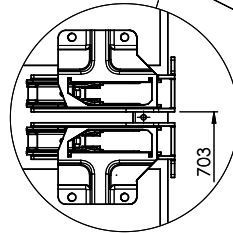
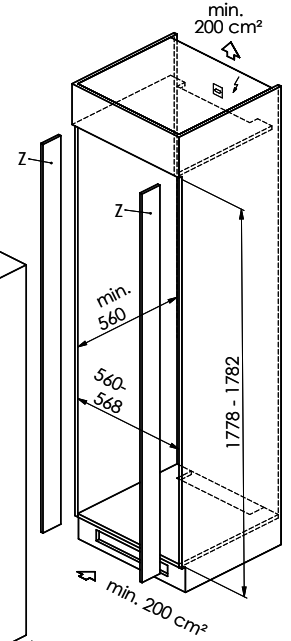
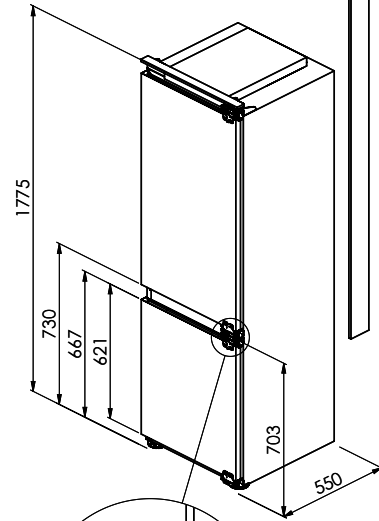
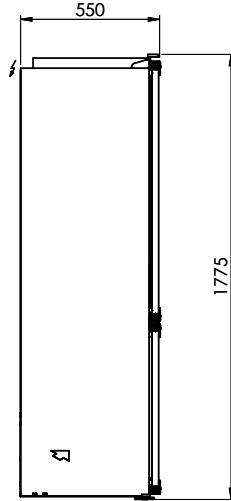
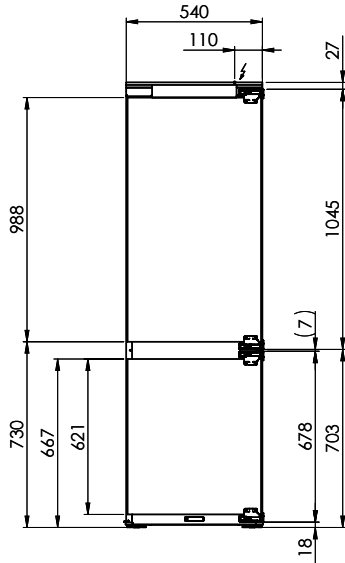

EKG130: 230 V / 10 A, T12, 2500 mm <sup>2</sup>Montagezubehör siehe: [www.suter.ch](http://www.suter.ch)