

Daneo DAN 110-50IF/A

[> Web link](#)



Fitting style
Flushmount sinks / Flat-mount inset

Model
DAN 110-50IF/A

Material
Stainless steel 18/10

Article no.
10.103.800.00

Cabinet size
55 cm

Basket
3½" Tipo

Surface
Matt

Price CHF
2'307.- excl. VAT

Dimensions
500x400x190mm

Corner radius
22 mm

Drainboard
Left

Overflow and drain technology



Sieve - type S

Swivelling overflow cap

Basket pre-assembly
Assembly of the valve at the factory

Dispenser - mounting option
All models

Overflow and drain technology
Standard pull-up knob

Prices (as of 06.05.26/excl. VAT)

Model	Material	Basket	Drainboard	Article no.	Price CHF
Daneo DAN 110-50IF/A	Stainless steel 18/10, Matt	3½" Tipo	Left	10.103.800.00	2'307.- > Weblink
		3½" Tipo	Right	10.103.801.00	2'307.- > Weblink
		3½" TouchFlow	Left	10.103.798.00	2'546.- > Weblink
		3½" TouchFlow	Right	10.103.799.00	2'546.- > Weblink

Product description

1 Product Model, 2 Installation Types

The special advantage of IF models: Installation as flush with the adjacent areas as well as laid flat on top is possible.

Flush-mounted installation: Recommendation for the choice of worktop:

We recommend installation in worktops made of ceramic, granite, artificial stone (e.g. Corian or Varicor) or solid wood. We do not recommend installation in coated chipboard.

Accessory

Optional accessories



> Weblink
40.000.912.00 / CHF 106.-
Colander, perforated



> Weblink
40.001.289.00 / CHF 106.-
Colander, unperforated

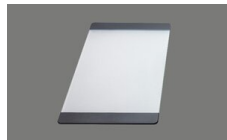

> Weblink
40.000.909.00 / CHF 151.-
Chopping board, made of glass, white

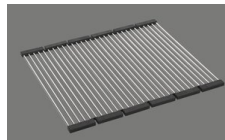

> Weblink
40.001.140.00 / CHF 125.-
Inox Pad

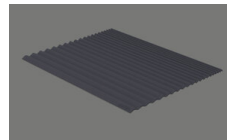

> Weblink
40.002.008.00 / CHF 51.-
Maro dish drainer mat, Dark Grey

Spares

You can find the compatible range of spares here > [Weblink](#)

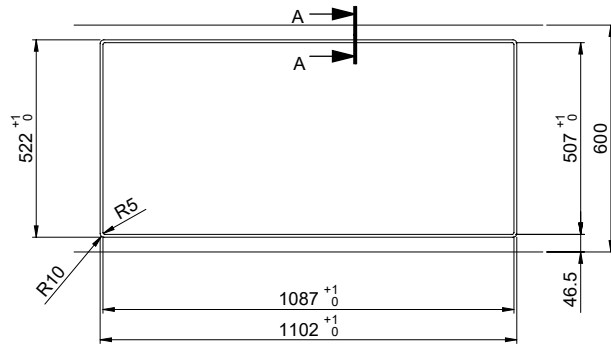

A-A (1 : 2)

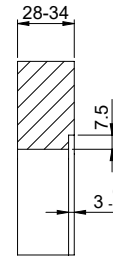

X (1:1)

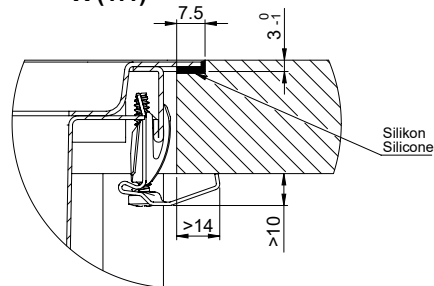

Vom flächenbündigen Einbau in beschichteten Spanplatten raten wir ab.
 Nous vous déconseillons le montage à fleur sur des panneaux de particules enduits.
 Sconsigliamo il montaggio a filo top in pannelli di truciolato laminato.

Für dieses Dokument und den darin dargestellten Gegenstand behalten wir uns alle Rechte vor. Verwendung, Beibehaltung an
 anderen Orten, Verbreitung, sowie Nachdruck, Vervielfältigung und Verbreitung, auch auszugsweise, ist ohne schriftliche Genehmigung der Suter AG. Copyright © 2010 Suter AG. All rights reserved.

