

Daneo DAN 50IF/12

[> Web link](#)



Cabinet size 55 cm

Fitting style
Flushmount sinks / Flat-mount inset

Model
DAN 50IF/12

Material
Stainless steel 18/10

Article no.
10.104.677.00

Cabinet size
55 cm

Basket
3½" eFlow Desino

Surface
Matt

VRG
0.19

Price CHF
1'563.- excl. VAT

Dimensions
500x400x175mm

Corner radius
22 mm

Overflow and drain technology



Desino: Concealed drain with basket underneath - type M



Concealed overflow eFlow

Basket pre-assembly
Basket pre-assembly ex works

Dispenser - mounting option
Free choice of positioning

Overflow and drain technology
Standard pull-up knob

Prices (as of 21.06.26/excl. VAT)

Model	Material	Basket	Article no.	Price CHF
Daneo DAN 50IF/12	Stainless steel 18/10, Matt	3½" Tipo Desino	10.105.724.00	1'238.- > Weblink
		3½" Space-saving Desino	10.104.658.00	1'238.- > Weblink
		3½" TouchFlow Desino	10.104.657.00	1'448.- > Weblink
		3½" eFlow Desino	10.104.677.00	1'563.- > Weblink

Product description

1 Product Model, 2 Installation Types

The special advantage of IF models: Installation as flush with the adjacent areas as well as laid flat on top is possible.

Flush-mounted installation: Recommendation for the choice of worktop:

We recommend installation in worktops made of ceramic, granite, artificial stone (e.g. Corian or Varicor) or solid wood. We do not recommend installation in coated chipboard.

Cleaning

The Desino Drain Sieve is dishwasher-safe and can be cleaned completely or separately up to a maximum temperature of 65°C.

Accessory

Optional accessories



> Weblink
40.000.912.00 / CHF 106.-
Colander, perforated



> Weblink
40.001.289.00 / CHF 106.-
Colander, unperforated



> Weblink
40.000.909.00 / CHF 151.-
Chopping board, made of glass, white



> Weblink
40.001.277.00 / CHF 151.-
Chopping board, made of plastic

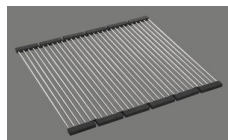

> Weblink
40.001.138.00 / CHF 125.-
Inox Pad

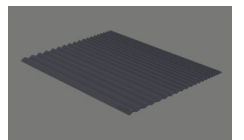

> Weblink
40.002.008.00 / CHF 51.-
Maro dish drainer mat, Dark Grey

Daneo DAN 50IF/12 > Web link

Spares

You can find the compatible range of spares here > Weblink

Daneo DAN 50IF/12 Desino

Randbreite 12mm
Bord de 12mm de largeur
Larghezza bordo 12mm

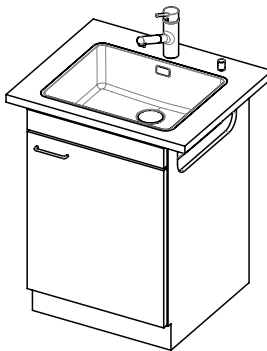
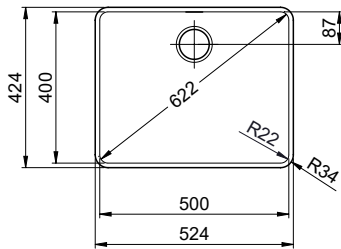

Für 12mm Arbeitsplatte.
 Pour plan de travail de 12mm.
 Per piano di lavoro da 12mm.

X (1 : 2)



Y (1 : 2)



Silikonieren
 Appliquer du silicone
 Applicare il silicone

Traverse
 Transversale
 Traversa

Für 13 - 30mm Arbeitsplatte.
 Pour plan de travail de 13 - 30mm.
 Per piano di lavoro da 13 - 30mm.

X (1 : 2)



Y (1 : 2)

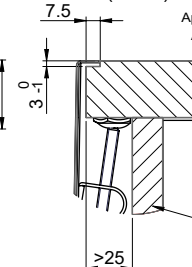

Silikonieren
 Appliquer du silicone
 Applicare il silicone

Traverse
 Transversale
 Traversa

Für 13 - 50mm Arbeitsplatte.
 Pour plan de travail de 13 - 50mm.
 Per piano di lavoro da 13 - 50mm.

X (1 : 2)



Y (1 : 2)

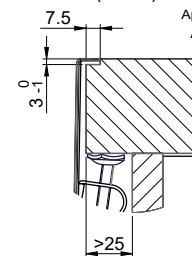

Silikonieren
 Appliquer du silicone
 Applicare il silicone

Traverse
 Transversale
 Traversa

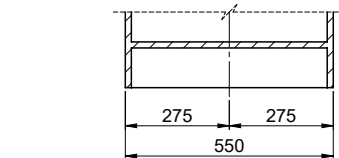
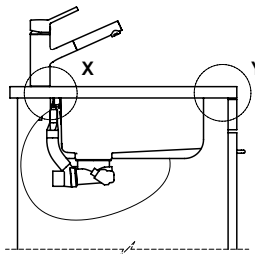

Bei der Planung die Traverse im Möbel beachten!

Faites attention à la barre transversale dans les meubles lors de la planification!

Presta attenzione alla traversa nei mobili durante la pianificazione!

Vom flächenbündigen Einbau in beschichteten Spanplatten raten wir ab.

Nous vous déconseillons le montage à fleur sur des panneaux de particules enduits.

Sconsigliamo il montaggio a filo top in pannelli di truciolato laminato.

Bohrung für Zug- und Druckknöpfe ø14
 Bohrung für Drehknopf ø25

Trou pour boutons et Poussoirs de commande ø14
 Trou pour bouton rotatif ø25

Foro per Pomelli tiranti e Pomelli pulsanti ø14
 Foro per Pomolo girevoli ø25

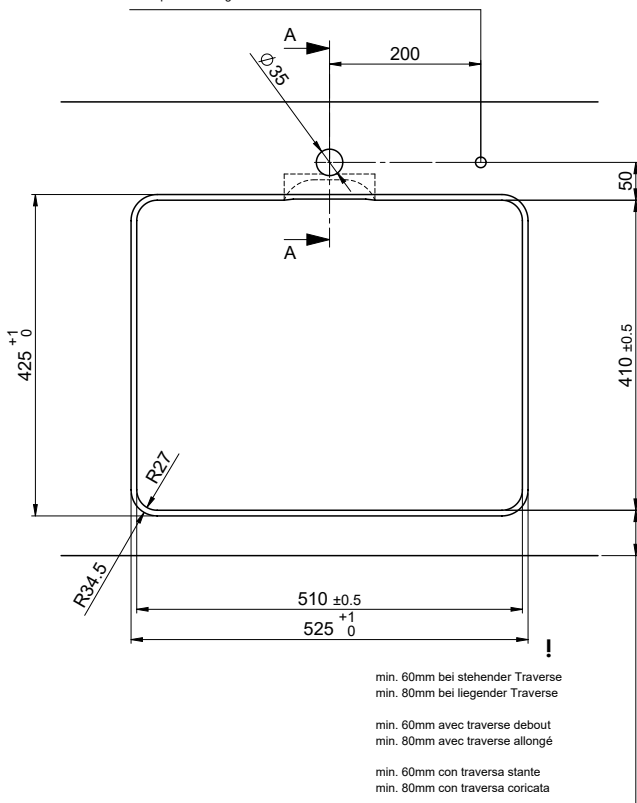

min. 60mm bei stehender Traverse
 min. 80mm bei liegender Traverse

min. 60mm avec traverse debout
 min. 80mm avec traverse allongé

min. 60mm con traversa stante
 min. 80mm con traversa coricata

Für 12mm Arbeitsplatte.
 Pour plan de travail de 12 mm.
 Per piano di lavoro da 12 mm.

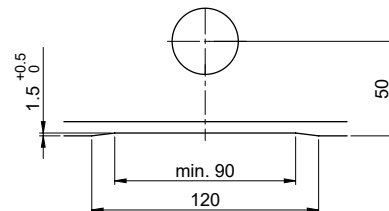

A-A (1 : 2)

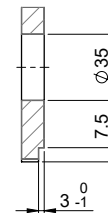

Für 13 - 30mm Arbeitsplatte.
 Pour plan de travail de 13 - 30mm.
 Per piano di lavoro da 13 - 30mm.

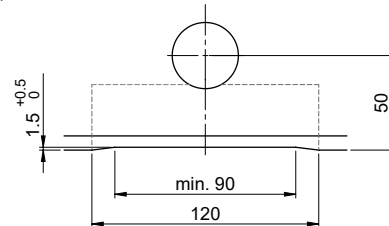

A-A (1 : 2)

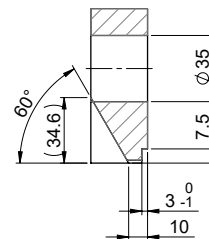

Für 13 - 50mm Arbeitsplatte.
 Pour plan de travail de 13 - 50mm.
 Per piano di lavoro da 13 - 50mm.

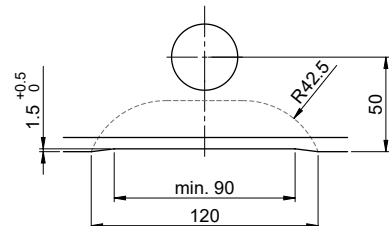

A-A (1 : 2)

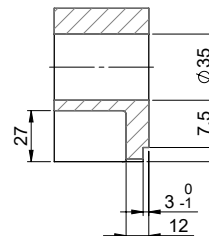

Daneo DAN 50IF/12 Desino

Suter Inox AG
 Schallerstrasse 25
 CH-1116 Schynsach-Bad
 T +41 26 923 64 00
 info@suterinox.ch
 suterinox

Ausschnitt für flach aufliegende Einbau - Randbreite 12mm:
 Mesure de coupure pour montage en appui - Bord de 12mm de largeur:
 Intaglio per montaggio soprapiano - Larghezza bordo 12mm:

SUTER

Bohrung für Zug- und Druckknöpfe ø14
 Bohrung für Drehknopf ø25

Trou pour boutons et Poussoirs de commande ø14
 Trou pour bouton rotatif ø25

Foro per Pomelli tiranti e Pomelli pulsanti ø14
 Foro per Pomolo girevoli ø25

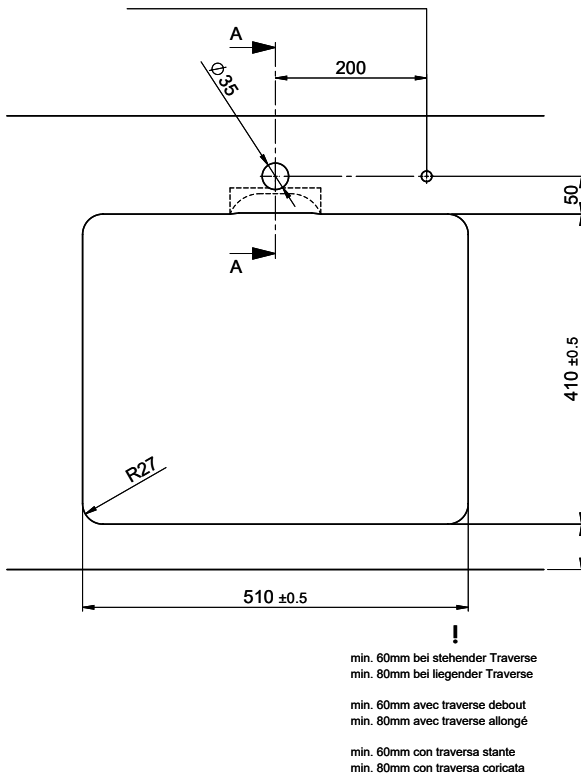

Für 12mm Arbeitsplatte.
 Pour plan de travail de 12 mm.
 Per piano di lavoro da 12 mm.

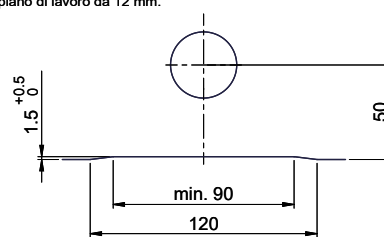

A-A (1 : 2)

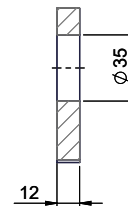

Für 13 - 30mm Arbeitsplatte.
 Pour plan de travail de 13 - 30mm.
 Per piano di lavoro da 13 - 30mm.

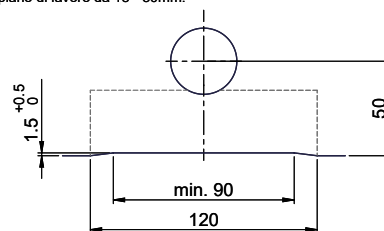

A-A (1 : 2)

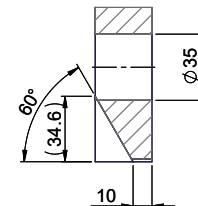

Für 13 - 50mm Arbeitsplatte.
 Pour plan de travail de 13 - 50mm.
 Per piano di lavoro da 13 - 50mm.

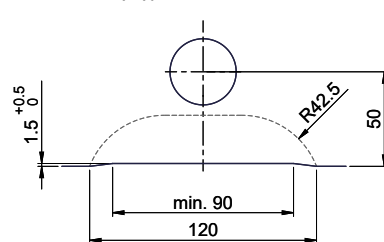

A-A (1 : 2)

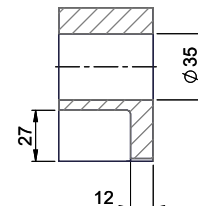

Für diese Dokumenten und den darin angegebenen Geometrien behalten wir uns alle Rechte vor. Verwendungs- oder Montageanweisungen sind dem Benutzer zu entnehmen. Die Verantwortung für die richtige Anwendung liegt beim Benutzer. © Copyright 2020 Suter Inox AG. Alle Rechte vorbehalten.