

Daneo DAN CP 55F/17

[> Web link](#)

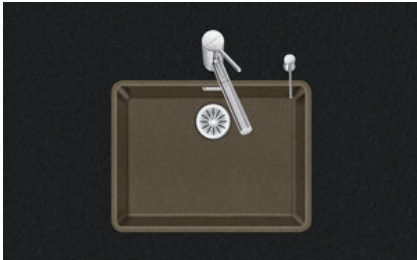

Fitting style
Flushmount sinks
Model
DAN CP 55F/17
Material
Cristalite Plus
Article no.
10.104.727.00

Cabinet size
60 cm
Basket
3½" Tipo
Color
Mocha
Price CHF
1'344.- excl. VAT

Dimensions
550x400x165mm
Corner radius
22 mm

Overflow and drain technology



Sieve - type S, for granite sinks



Swivelling overflow cap for granite sinks

Basket pre-assembly
Assembly of the valve at the factory

Dispenser - mounting option
Free choice of positioning

Overflow and drain technology
Standard pull-up knob

Prices (as of 06.05.26/excl. VAT)

Model	Material	Basket	Article no.	Price CHF
Daneo DAN CP 55F/17 - Mocha	Cristalite Plus, Mocha	3½" Tipo	10.104.727.00	1'344.- > Weblink
		3½" Space-saving	10.104.726.00	1'385.- > Weblink
		3½" TouchFlow	10.104.725.00	1'583.- > Weblink

Product description

Material

Granite sinks Cristalite Plus: Schock sinks are composed of approx. 80 % quartz, the hardest component of granite. The quartz is bound by the highest quality of acrylic. The composition of acrylic and quartz makes the sinks extremely resistant against scratches and dirt and is responsible for their longevity.
Only available for flushmount installation.

Flush-mounted installation: Recommendation for the choice of worktop:

We recommend installation in worktops made of ceramic, granite, artificial stone (e.g. Corian or Varicor) or solid wood. We do not recommend installation in coated chipboard.

Accessory

You can find the complete range of accessories here [> Weblink](#)

Optional accessories



> Weblink
40.000.912.00 / CHF 106.-
Colander, perforated



> Weblink
40.001.289.00 / CHF 106.-
Colander, unperforated

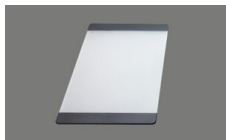

> Weblink
40.000.909.00 / CHF 151.-
Chopping board, made of glass, white



> Weblink
40.001.277.00 / CHF 151.-
Chopping board, made of plastic

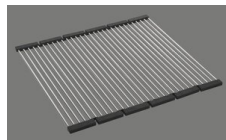

> Weblink
40.001.138.00 / CHF 125.-
Innox Pad



> Weblink
40.001.509.00 / CHF 29.-
Easy Care cleaning kit for granite sinks

Spares

You can find the compatible range of spares here [> Weblink](#)

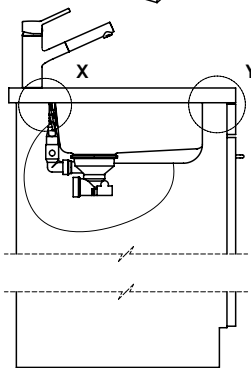
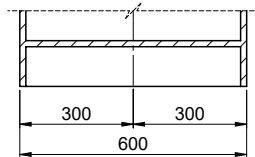

Vom flächenbündigen Einbau in beschichteten Spanplatten raten wir ab.
 Nous vous déconseillons le montage à fleur sur des panneaux de particules enduits.
 Sconsigliamo il montaggio a filo top in pannelli di truciolo laminato.

Bei der Planung die Traverse im Möbel beachten!
 Faites attention à la barre transversale dans les meubles lors de la planification!
 Presta attenzione alla traversa nei mobili durante la pianificazione!

Für 12mm Arbeitsplatte.
 Pour plan de travail de 12mm.
 Per piano di lavoro da 12mm.

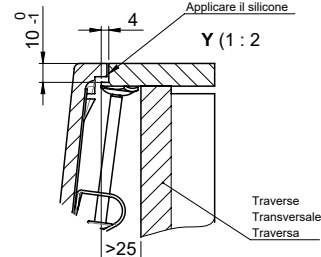

Für 13 - 30mm Arbeitsplatte.
 Pour plan de travail de 13 - 30mm.
 Per piano di lavoro da 13 - 30mm.



Für 13 - 50mm Arbeitsplatte.
 Pour plan de travail de 13 - 50mm.
 Per piano di lavoro da 13 - 50mm.

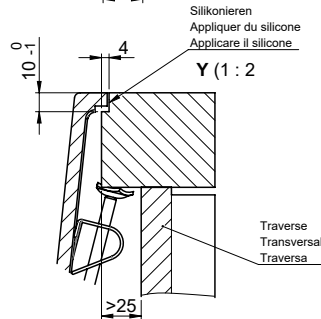

Bohrung für Zug- und Druckknöpfe ø14
 Bohrung für Drehknopf ø25

Trou pour boutons et Poussoirs de commande ø14
 Trou pour bouton rotatif ø25

Foro per Pomelli tiranti e Pomelli pulsanti ø14
 Foro per Pomolo girevoli ø25

Für 12mm Arbeitsplatte.
 Pour plan de travail de 12 mm.
 Per piano di lavoro da 12 mm.

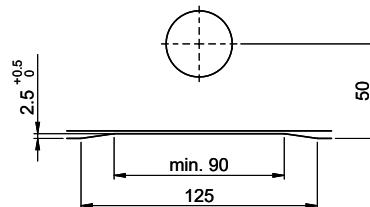

A-A (1 : 2)



Für 13 - 30mm Arbeitsplatte.
 Pour plan de travail de 13 - 30mm.
 Per piano di lavoro da 13 - 30mm.



A-A (1 : 2)

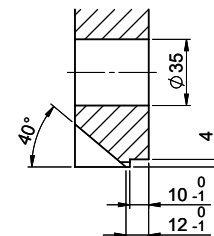

Für 13 - 50mm Arbeitsplatte.
 Pour plan de travail de 13 - 50mm.
 Per piano di lavoro da 13 - 50mm.



A-A (1 : 2)



min. 60mm bei stehender Traverse
 min. 80mm bei liegender Traverse

min. 60mm avec traverse debout
 min. 80mm avec traverse allongé

min. 60mm con traversa stante
 min. 80mm con traversa coricata

Für diese Dokumenten und den darin abgesetzten Gegenstand behalten wir uns alle Rechte vor. Verwendbar ist das Dokument nur für den vorgesehenen Zweck. Die Weitergabe oder die Herstellung von Kopien ist ohne schriftliche Zustimmung der Suterinox AG. Copyright © 2020 Suterinox AG. Alle Rechte vorbehalten.