

**Daneo DAN CP 55F/17** > Web link



**Fitting style**  
Flushmount sinks  
**Model**  
DAN CP 55F/17  
**Material**  
Cristalite Plus  
**Article no.**  
10.104.729.00

**Cabinet size**  
60 cm  
**Basket**  
3½" Space-saving  
**Color**  
Everest  
**Price CHF**  
1'385.- excl. VAT

**Dimensions**  
550x400x165mm  
**Corner radius**  
22 mm

**Overflow and drain technology**



Sieve - type S, for granite sinks



Swivelling overflow cap for granite sinks

**Basket pre-assembly**  
Assembly of the valve at the factory

**Dispenser - mounting option**  
Free choice of positioning

**Overflow and drain technology**  
**Standard pull-up knob**



Advant

**Prices (as of 20.06.26/excl. VAT)**

Model	Material	Basket	Article no.	Price CHF
Daneo DAN CP 55F/17 - Everest	Cristalite Plus, Everest	3½" Tipo	10.104.730.00	1'344.- > Weblink
		3½" Space-saving	10.104.729.00	1'385.- > Weblink
		3½" TouchFlow	10.104.728.00	1'583.- > Weblink

**Product description**

**Material**

Granite sinks Cristalite Plus: Schock sinks are composed of approx. 80 % quartz, the hardest component of granite. The quartz is bound by the highest quality of acrylic. The composition of acrylic and quartz makes the sinks extremely resistant against scratches and dirt and is responsible for their longevity.  
**Only available for flushmount installation.**

**Flush-mounted installation: Recommendation for the choice of worktop:**

We recommend installation in worktops made of ceramic, granite, artificial stone (e.g. Corian or Varicor) or solid wood. We do not recommend installation in coated chipboard.

**Accessory** You can find the complete range of accessories here > Weblink

Optional accessories



> Weblink  
40.000.912.00 / CHF 106.-  
Colander, perforated



> Weblink  
40.001.289.00 / CHF 106.-  
Colander, unperforated



> Weblink  
40.000.909.00 / CHF 151.-  
Chopping board, made of glass, white



> Weblink  
40.001.277.00 / CHF 151.-  
Chopping board, made of plastic

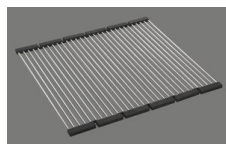

> Weblink  
40.001.138.00 / CHF 125.-  
Inox Pad



> Weblink  
40.001.509.00 / CHF 29.-  
Easy Care cleaning kit for granite sinks

**Spares**

You can find the compatible range of spares here > Weblink

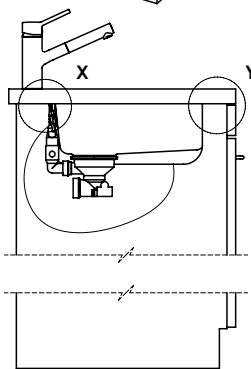
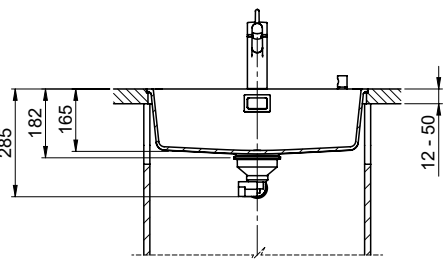

Vom flächenbündigen Einbau in beschichteten Spanplatten raten wir ab.  
 Nous vous déconseillons le montage à fleur sur des panneaux de particules enduits.  
 Sconsigliamo il montaggio a filo top in pannelli di truciolato laminato.

Bei der Planung die Traverse im Möbel beachten!  
 Faites attention à la barre transversale dans les meubles lors de la planification!  
 Presta attenzione alla traversa nei mobili durante la pianificazione!

Für 12mm Arbeitsplatte.  
 Pour plan de travail de 12mm.  
 Per piano di lavoro da 12mm.



Für 13 - 30mm Arbeitsplatte.  
 Pour plan de travail de 13 - 30mm.  
 Per piano di lavoro da 13 - 30mm.



Für 13 - 50mm Arbeitsplatte.  
 Pour plan de travail de 13 - 50mm.  
 Per piano di lavoro da 13 - 50mm.



Bohrung für Zug- und Druckknöpfe ø14  
 Bohrung für Drehknopf ø25

Trou pour boutons et Poussoirs de commande ø14  
 Trou pour bouton rotatif ø25

Foro per Pomelli tiranti e Pomelli pulsanti ø14  
 Foro per Pomolo girevoli ø25

Für 12mm Arbeitsplatte.  
 Pour plan de travail de 12 mm.  
 Per piano di lavoro da 12 mm.

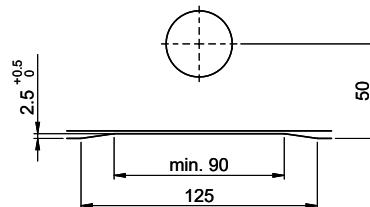

A-A (1 : 2)



Für 13 - 30mm Arbeitsplatte.  
 Pour plan de travail de 13 - 30mm.  
 Per piano di lavoro da 13 - 30mm.

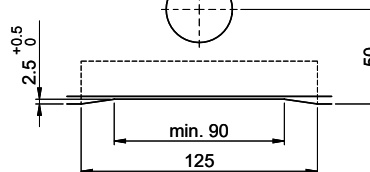

A-A (1 : 2)

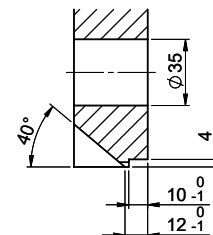

Für 13 - 50mm Arbeitsplatte.  
 Pour plan de travail de 13 - 50mm.  
 Per piano di lavoro da 13 - 50mm.



A-A (1 : 2)

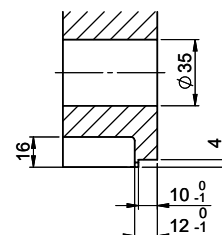

Für diese Dokumenten und den darin abgedruckten Informationen behalten wir uns alle Rechte vor. Verwendungs- und Montageanweisungen sind Bestandteil dieses Produkts. © Copyright 2020 Suter Inox AG. Alle Rechte vorbehalten.