

## Samsung EGS120 built-in dishwasher

[> Web link](#)

**Model**  
Samsung EGS120 built-in dishwasher

**Energy efficiency class**  
D (New Label 03.21)

**Manufacturer ID**  
DW60A6092IB/ET

**Article no.**  
500.000.156.00

**Appliance type**  
Dishwasher

**VRG**  
10.00

**Price CHF**  
1'792.- excl. VAT

## Highlights

- Kitchen Fit™-Sliding Door
- Automatic door opener - for clean and dry dishes
- Capacity: 14 standard place settings
- Easy to install at height
- 7 washing programs
- 60 min. express program - for normally soiled dishes
- Flexible cutlery drawer
- Sound power level: 44 dB(A)
- Aqua-stop - for maximum safety
- Automatic program - with automatic detection of degree of soiling

## Product description

Construction type: **Euro-Norm 60 cm**  
GTIN nuber: **8806090955341**

## Consumption

Energy efficiency class (from A to G): **D**  
Efficiency index: **49.9**  
Energy consumption per cycle: **0,848 kWh**  
Energy consumption: **84,8 kWh / 100 cycles**  
Water consumption per cycle: **10,5 L**  
Power consumption in off- / standby mode / time preselection / networked standby mode (if available): **0.49 / - / 1 / - W**

## Performance properties

Duration (program ECO): **210 Min.**  
Holding capacity (place settings): **14**

Cleaning performance index: **1.13**  
Drying performance index: **1.07**  
Noise (dB(A), built-in unit): **44 dB(A)**  
Airborne sound emission class : **B**

## Mounting type

Built-in unit: **Yes**  
Large capacity version: -  
Freestanding with worktop:-  
Freestanding undercounter: **Yes**  
Countertop installation: **Yes**  
Decoratable: -  
Integratable: -  
Fully integratable: **Yes**

## Design

Housing color:**Stainless steel**  
Handle: -  
Control element: **hidden** (fully integrated)

**Samsung EGS120 built-in dishwasher**[> Web link](#)**Display and operation**

Indicator: **Digital display**  
Display and lighting: **LED, Ice Blue**  
Operation: **Touch operation**

**Interconnection of household appliances**

Samsung Smart Home: -

**Dimensions**

Unit dimensions (H x W x D): **817 x 598 x 550 mm**  
Height adjustable: **0-60 mm** (total height 817 - 877 mm)

**Empty weight**

Unit weight: **44 kg**

**Fittings**

Holding capacity (place settings): **14**  
Upper rack: **Adjustable height, foldable cup rows, pull-out handle, glass holder**  
Lower rack: **Fold-down tines for plates, extendable handle**  
Cutlery: **Third loading level**  
Interior lining: **Stainless steel**  
interior lighting: -  
Cleaning system: **Rotating spray arm**

**Functions**

Drying system: **Drying + Automatic door opener**

**Programs / display**

Number of washing programs: **7**  
Washing programs: **Auto, ECO, Intensive, Short programme, Gentle Wash, Express, Self-clean**  
Options: **Half load, hygienic washing, delay start, child safety**

**Safety**

Aqua-stop hose: **Yes**  
Leakage sensor: **Yes**  
Child safety: **Yes**

**Power and water supply****Electrical connection**

Voltage: **230 V**  
Frequency: **50 Hz**  
Connection values: **1,8 kW**  
Fuse protection: **10 A**  
Length power connection: **1,5 m**  
Power plug: **Schuko plug with CH adapter (type 12, 10A)**

**Water connection**

Pressure hose G 3/4": **Yes**  
Connectable to cold/hot water: **max. 60° C**  
Water inlet: **1,5 m, flexible hose with Aqua-stop**  
Water outlet: **1,6 m, flexible hose**

**Technical data**

Standard width: **Euro-Norm 60 cm**  
Niche height: **820 - 880 mm**  
Niche width: **600 mm**  
Niche depth: **min. 560 mm**  
Height for substructure: **817 - 877 mm**  
Depth with door open: **1250 mm**  
Max. door front weight: **10 kg**  
Unit width: **598 mm**  
Unit height: **817 mm**  
Unit depth: **550 mm**  
**Salt funnel (incl): DD81-02921A**

**Packaging**

Weight, incl. packaging: **51 kg**  
Packaging dimensions (H x W x D): **875 x 655 x 645 mm**

**Samsung EGS120 built-in dishwasher** [> Web link](#)

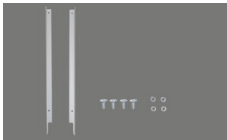

**Accessory**

Optional accessories

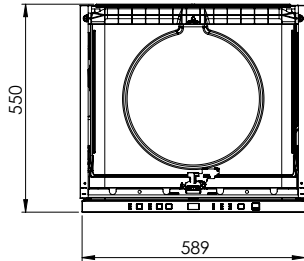
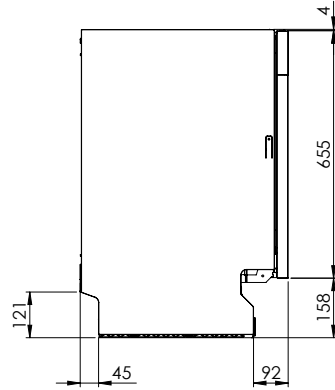
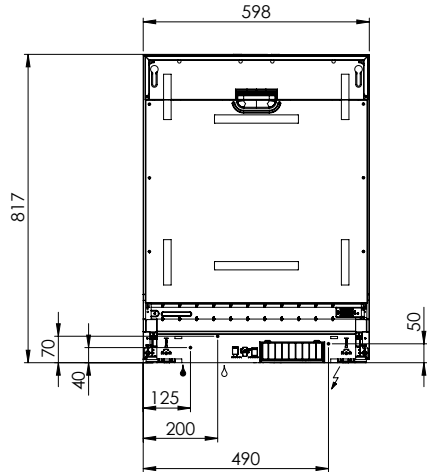

[> Weblink](#)  
500.000.091.00 / CHF  
61.-  
Mounting kit EGS110,  
EGS120, EGS130



-  EGS120: 230 V / 10 A, T12, 1500 mm
-  Wasserzulauf / Flexible de raccordement, 1500 mm
-  Wasserablauf / Évacuation, 1600 mm

