

## Linero LIO 18F/7

[> Web link](#)



**Fitting style**  
Flushmount sinks

**Model**  
LIO 18F/7

**Material**  
Stainless steel 18/10

**Article no.**  
10.105.234.00

**Cabinet size**  
35 cm

**Basket**  
3½" TouchFlow Desino

**Surface**  
Matt

**VRG**  
0.19

**Price CHF**  
1'378.- excl. VAT

**Dimensions**  
180x400x140mm

**Corner radius**  
15 mm

### Overflow and drain technology



Desino: Concealed drain with basket underneath - type M



Swivelling TouchFlow overflow cap

### Basket pre-assembly

Basket pre-assembly ex works

### Overflow and drain technology

Standard pull-up knob

### Prices (as of 21.06.26/excl. VAT)

Model	Material	Basket	Article no.	Price CHF
Linero LIO 18F/7	Stainless steel 18/10, Matt	3½" Tipo Desino	10.105.652.00	1'168.- > Weblink
		3½" TouchFlow Desino	10.105.234.00	1'378.- > Weblink
		3½" eFlow Desino	10.105.233.00	1'493.- > Weblink

### Product description

The Desino Drain Sieve is dishwasher-safe and can be cleaned completely or separately up to a maximum temperature of 65°C.

### Accessory

#### Optional accessories



> Weblink  
40.000.912.00 / CHF 106.-  
Colander, perforated



> Weblink  
40.001.289.00 / CHF 106.-  
Colander, unperforated



> Weblink  
40.001.277.00 / CHF 151.-  
Chopping board, made of plastic

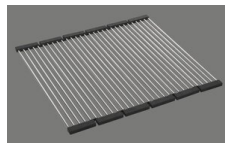

> Weblink  
40.001.138.00 / CHF 125.-  
Inox Pad

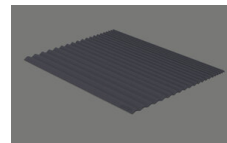

> Weblink  
40.002.008.00 / CHF 51.-  
Maro dish drainer mat, Dark Grey

### Spares

You can find the compatible range of spares here [> Weblink](#)

# Linero LIO 18F/7 Desino

**Randbreite 7mm**  
**Bord de 7mm de largeur**  
**Larghezza bordo 7mm**

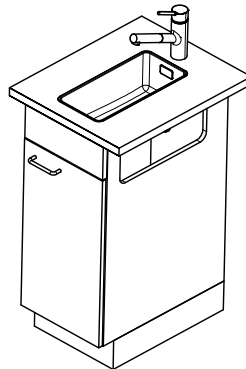
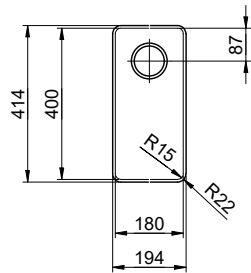

Für 12mm Arbeitsplatte.  
 Pour plan de travail de 12mm.  
 Per piano di lavoro da 12mm.

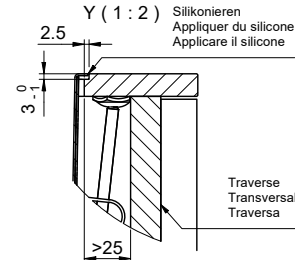
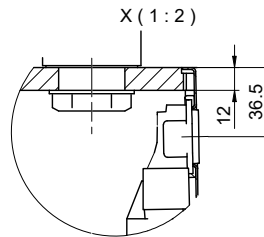

Für 13 - 30mm Arbeitsplatte.  
 Pour plan de travail de 13 - 30mm.  
 Per piano di lavoro da 13 - 30mm.

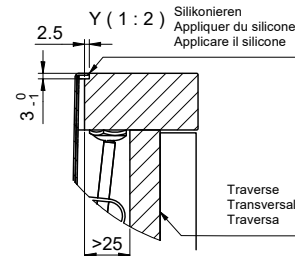
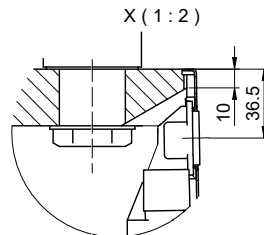

Für 13 - 50mm Arbeitsplatte.  
 Pour plan de travail de 13 - 50mm.  
 Per piano di lavoro da 13 - 50mm.

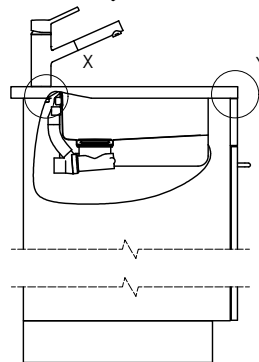
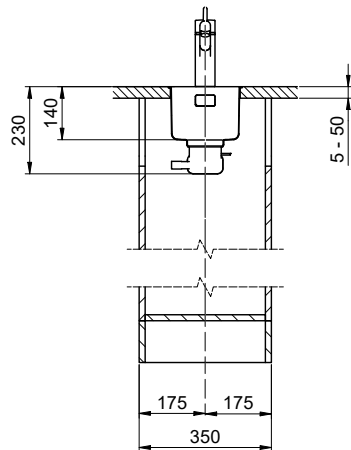
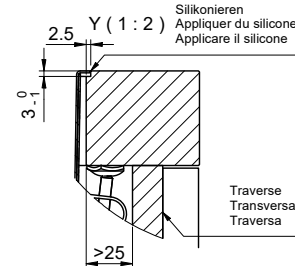
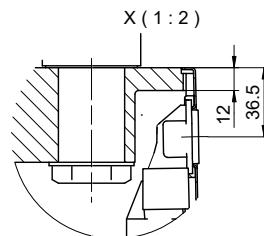

Bei der Planung die Traverse im Möbel beachten!

Faites attention à la barre transversale dans les meubles lors de la planification!

Presta attenzione alla traversa nei mobili durante la pianificazione!

Vom flächenbündigen Einbau in beschichtete Spanplatten raten wir ab.

Nous vous déconseillons le montage à fleur sur des panneaux de particules enduits.

Sconsigliamo il montaggio a filo top in pannelli di truciolato laminato.

# Linero LIO 18F/7 Desino

**Ausschnitt für flächenbündigen Einbau - Randbreite 7mm:**  
**Mesure de coupure pour montage à fleur - Bord de 7mm de largeur:**  
**Intaglio per montaggio a filo top - Larghezza bordo 7mm:**

A-A (1 : 2)

Für 12mm Arbeitsplatte.  
 Pour plan de travail de 12mm.  
 Per piano di lavoro da 12mm.

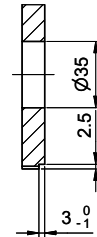
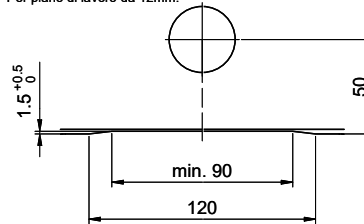

A-A (1 : 2)

Für 13 - 30mm Arbeitsplatte.  
 Pour plan de travail de 13 - 30mm.  
 Per piano di lavoro da 13 - 30mm.

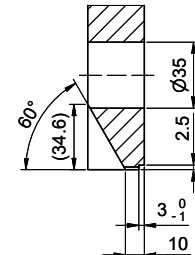
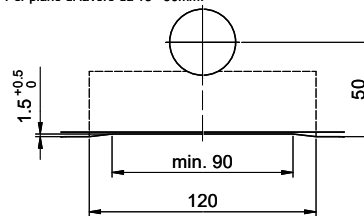

A-A (1 : 2)

Für 13 - 50mm Arbeitsplatte.  
 Pour plan de travail de 13 - 50mm.  
 Per piano di lavoro da 13 - 50mm.

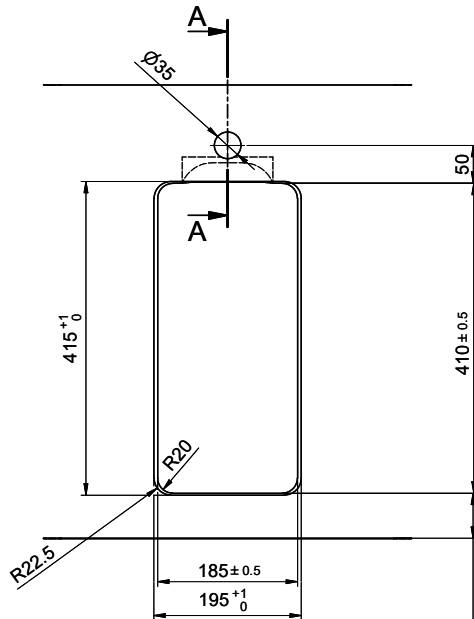
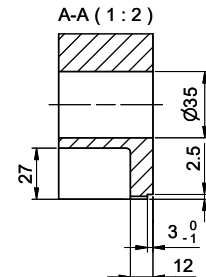
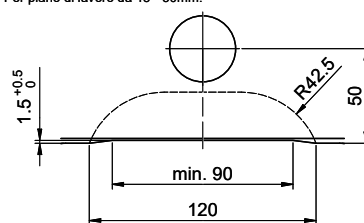

min. 60mm bei stehender Traverse.  
 min. 80mm bei liegender Traverse.

min. 60mm avec traverse debout.  
 min. 80mm avec traverse allongé.

min. 60mm con traversa stante.  
 min. 80mm con traversa coricata.