

Linero LIO 18F/7

[> Web link](#)



Fitting style
Flushmount sinks

Model
LIO 18F/7

Material
Stainless steel 18/10

Article no.
10.105.652.00

Cabinet size
35 cm

Basket
3½" Tipo Desino

Surface
Matt

Price CHF
1'168.- excl. VAT

Dimensions
180x400x140mm

Corner radius
15 mm

Overflow and drain technology



Tipo Desino:
Concealed drain with
basket underneath -
type M



Swivelling overflow
cap

Basket pre-assembly

Basket pre-assembly ex works

Dispenser - mounting option

Free choice of positioning

Overflow and drain technology

Prices (as of 06.05.26/excl. VAT)

Model	Material	Basket	Article no.	Price CHF
Linero LIO 18F/7	Stainless steel 18/10, Matt	3½" Tipo Desino	10.105.652.00	1'168.- > Weblink
		3½" TouchFlow Desino	10.105.234.00	1'378.- > Weblink
		3½" eFlow Desino	10.105.233.00	1'493.- > Weblink

Product description

The Desino Drain Sieve is dishwasher-safe and can be cleaned completely or separately up to a maximum temperature of 65°C.

Accessory

Optional accessories



> Weblink
40.000.912.00 / CHF
106.-
Colander, perforated



> Weblink
40.001.289.00 / CHF
106.-
Colander, unperforated

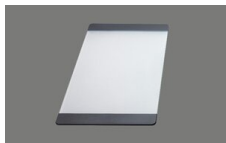

> Weblink
40.000.909.00 / CHF
151.-
Chopping board, made of
glass, white



> Weblink
40.001.277.00 / CHF
151.-
Chopping board, made of
plastic

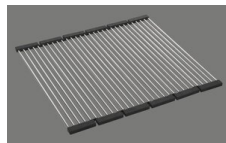

> Weblink
40.001.138.00 / CHF
125.-
Inox Pad

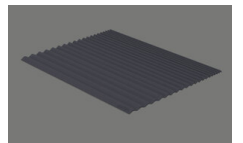

> Weblink
40.002.008.00 / CHF 51.-
Maro dish drainer mat,
Dark Grey

Spares

You can find the compatible range of spares here [> Weblink](#)

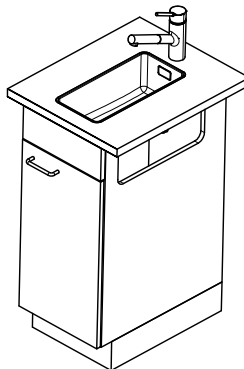
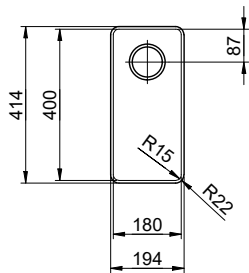

Für 12mm Arbeitsplatte.
 Pour plan de travail de 12mm.
 Per piano di lavoro da 12mm.

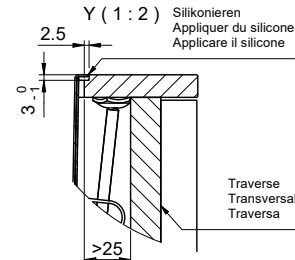
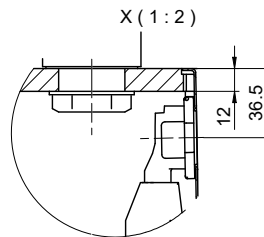

Für 13 - 30mm Arbeitsplatte.
 Pour plan de travail de 13 - 30mm.
 Per piano di lavoro da 13 - 30mm.

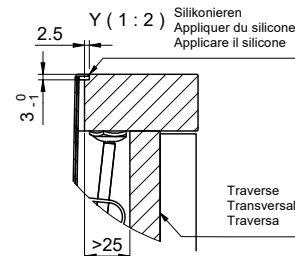
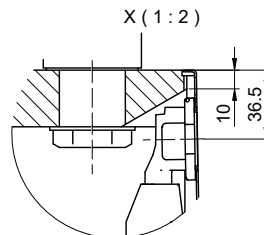

Für 13 - 50mm Arbeitsplatte.
 Pour plan de travail de 13 - 50mm.
 Per piano di lavoro da 13 - 50mm.

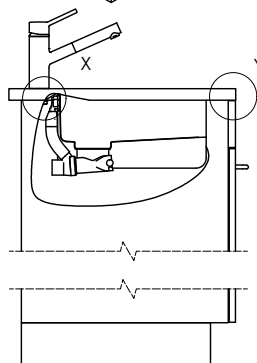
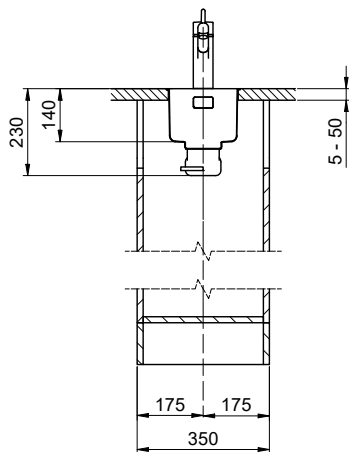
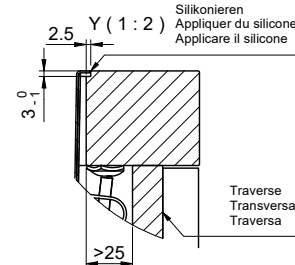
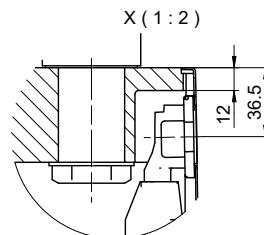

Bei der Planung die Traverse im Möbel beachten!

Faites attention à la barre transversale dans les meubles lors de la planification!

Presta attenzione alla traversa nei mobili durante la pianificazione!

Vom flächenbündigen Einbau in beschichtete Spanplatten raten wir ab.

Nous vous déconseillons le montage à fleur sur des panneaux de particules enduits.

Sconsigliamo il montaggio a filo top in pannelli di truciolato laminato.

Linero LIO 18F/7 Desino

Ausschnitt für flächenbündigen Einbau - Randbreite 7mm:
Mesure de coupure pour montage à fleur - Bord de 7mm de largeur:
Intaglio per montaggio a filo top - Larghezza bordo 7mm:

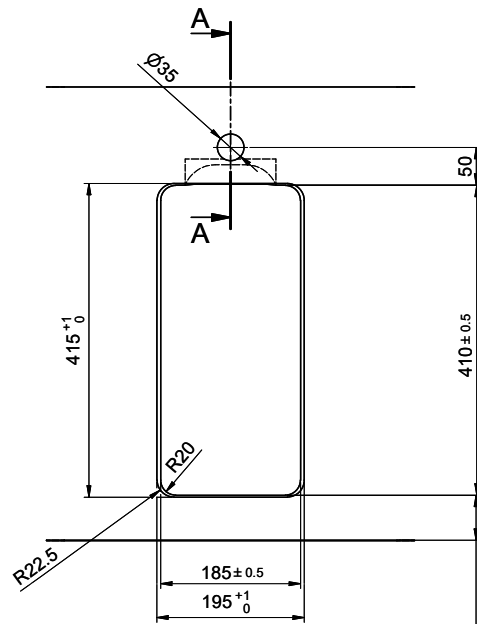

min. 60mm bei stehender Traverse.
 min. 80mm bei liegender Traverse.

min. 60mm avec traverse debout.
 min. 80mm avec traverse allongé.

min. 60mm con traversa stante.
 min. 80mm con traversa coricata.

Für 12mm Arbeitsplatte.
 Pour plan de travail de 12mm.
 Per piano di lavoro da 12mm.

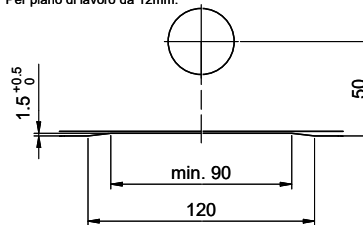

A-A (1 : 2)

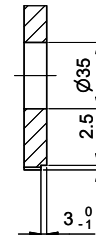

Für 13 - 30mm Arbeitsplatte.
 Pour plan de travail de 13 - 30mm.
 Per piano di lavoro da 13 - 30mm.

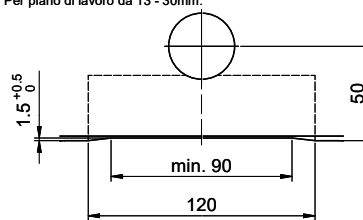

A-A (1 : 2)

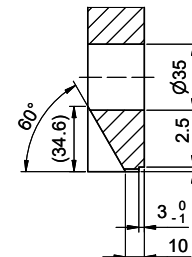

Für 13 - 50mm Arbeitsplatte.
 Pour plan de travail de 13 - 50mm.
 Per piano di lavoro da 13 - 50mm.

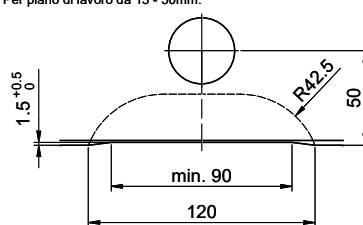

A-A (1 : 2)

