

**Linero LIO 34F/7**

[> Web link](#)



**Fitting style**  
Flushmount sinks

**Model**  
LIO 34F/7

**Material**  
Stainless steel 18/10

**Article no.**  
10.105.655.00

**Cabinet size**  
40 cm

**Basket**  
3½" Tipo Desino

**Surface**  
Matt

**Price CHF**  
1'498.- excl. VAT

**Dimensions**  
340x400x175mm

**Corner radius**  
15 mm

**Overflow and drain technology**



Tipo Desino:  
Concealed drain with  
basket underneath -  
type M



Swivelling overflow  
cap

**Basket pre-assembly**  
Basket pre-assembly ex works

**Dispenser - mounting option**  
Free choice of positioning

**Overflow and drain technology**

**Prices (as of 13.05.26/excl. VAT)**

Model	Material	Basket	Article no.	Price CHF	
Linero LIO 34F/7	Stainless steel 18/10, Matt	3½" Tipo Desino	10.105.655.00	1'498.-	> Weblink
		3½" Space-saving Desino	10.105.237.00	1'498.-	> Weblink
		3½" TouchFlow Desino	10.105.236.00	1'708.-	> Weblink
		3½" eFlow Desino	10.105.235.00	1'823.-	> Weblink

**Product description**

The Desino Drain Sieve is dishwasher-safe and can be cleaned completely or separately up to a maximum temperature of 65°C.

**Spares**

You can find the compatible range of spares here [> Weblink](#)

# Linero LIO 34F/7 Desino

**Randbreite 7mm**  
**Bord de 7mm de largeur**  
**Larghezza bordo 7mm**

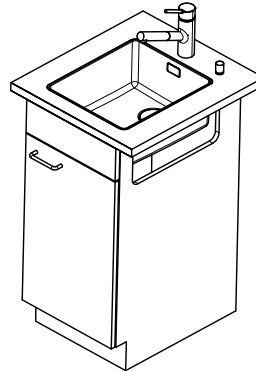
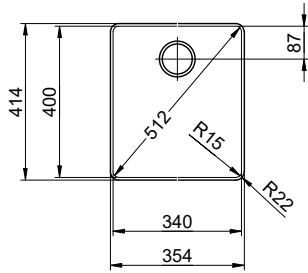

Für 12mm Arbeitsplatte.  
 Pour plan de travail de 12mm.  
 Per piano di lavoro da 12mm.

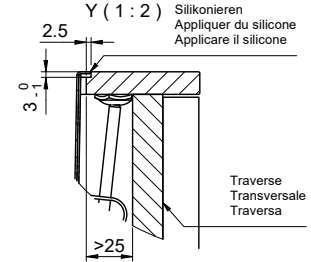
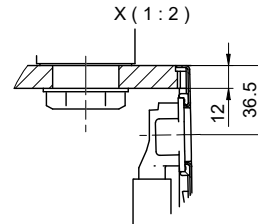

Für 13 - 30mm Arbeitsplatte.  
 Pour plan de travail de 13 - 30mm.  
 Per piano di lavoro da 13 - 30mm.

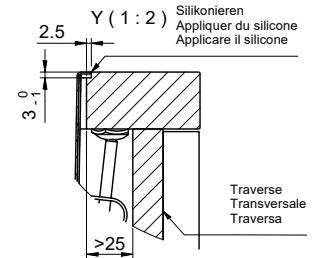
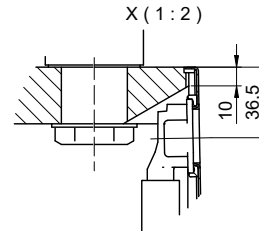

Für 13 - 50mm Arbeitsplatte.  
 Pour plan de travail de 13 - 50mm.  
 Per piano di lavoro da 13 - 50mm.

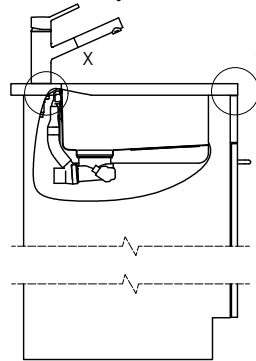
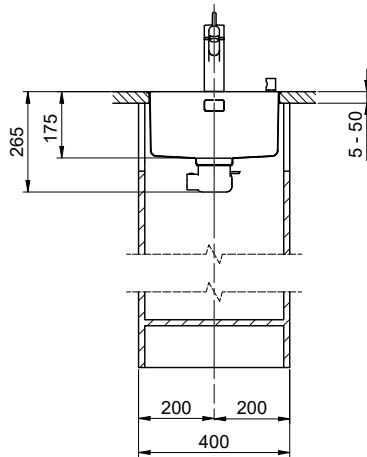
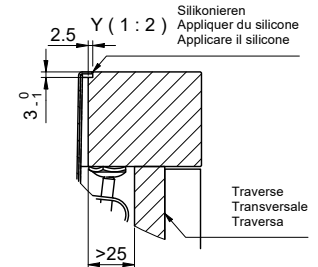
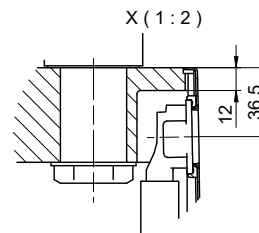

Bei der Planung die Traverse im Möbel beachten!

Faites attention à la barre transversale dans les meubles lors de la planification!

Presta attenzione alla traversa nei mobili durante la pianificazione!

Vom flächenbündigen Einbau in beschichtete Spanplatten raten wir ab.

Nous vous déconseillons le montage à fleur sur des panneaux de particules enduits.

Sconsigliamo il montaggio a filo top in pannelli di truciolato laminato.

# Linero LIO 34F/7 Desino

**Ausschnitt für flächenbündigen Einbau - Randbreite 7mm:**  
**Mesure de coupure pour montage à fleur - Bord de 7mm de largeur:**  
**Intaglio per montaggio a filo top - Larghezza bordo 7mm:**

Bohrung für Zug- und Druckknöpfe Ø14  
 Bohrung für Drehknopf Ø25

Trou pour boutons et Pousoirs de commande Ø14  
 Trou pour bouton rotatif Ø25

Foro per Pomelli tiranti e Pomelli pulsanti Ø14  
 Foro per Pomolo girevoli Ø25

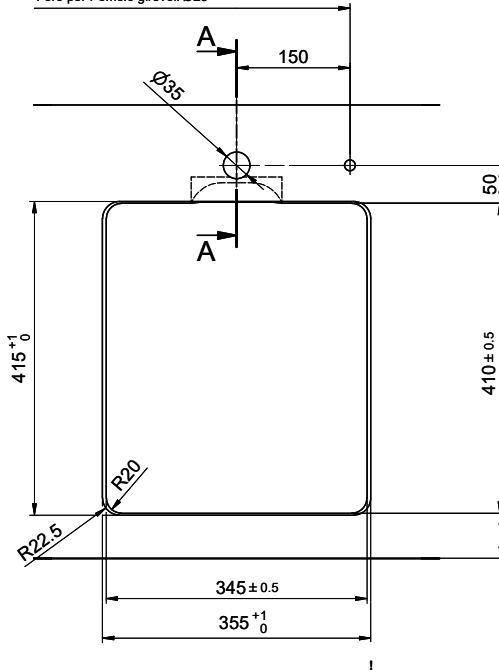

min. 60mm bei stehender Traverse.  
 min. 80mm bei liegender Traverse.

min. 60mm avec traverse debout.  
 min. 80mm avec traverse allongé.

min. 60mm con traversa stante.  
 min. 80mm con traversa coricata.

Für 12mm Arbeitsplatte.  
 Pour plan de travail de 12mm.  
 Per piano di lavoro da 12mm.

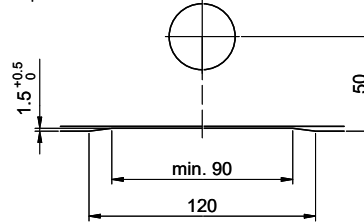

A-A (1 : 2)



Für 13 - 30mm Arbeitsplatte.  
 Pour plan de travail de 13 - 30mm.  
 Per piano di lavoro da 13 - 30mm.

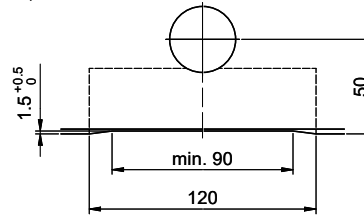

A-A (1 : 2)

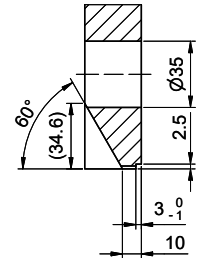

Für 13 - 50mm Arbeitsplatte.  
 Pour plan de travail de 13 - 50mm.  
 Per piano di lavoro da 13 - 50mm.

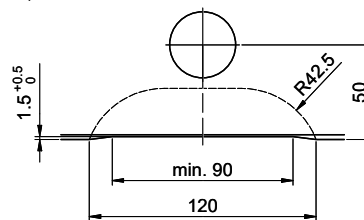

A-A (1 : 2)

