

Linero LIO 50F/7

[> Web link](#)



Fitting style
Flushmount sinks

Model
LIO 50F/7

Material
Stainless steel 18/10

Article no.
10.105.668.00

Cabinet size
55 cm

Basket
3½" TouchFlow

Surface
Matt

VRG
0.19

Price CHF
1'691.- excl. VAT

Dimensions
500x400x175mm

Corner radius
15 mm

Overflow and drain technology



Sieve - type M



Swivelling TouchFlow overflow cap

Basket pre-assembly

Basket pre-assembly ex works

Dispenser - mounting option

Free choice of positioning

Overflow and drain technology

Prices (as of 15.05.26/excl. VAT)

Model	Material	Basket	Article no.	Price CHF
Linero LIO 50F/7	Stainless steel 18/10, Matt	3½" Tipo	10.105.670.00	1'452.- > Weblink
		3½" Space-saving	10.105.669.00	1'493.- > Weblink
		3½" Space-saving	10.106.244.00	1'538.- > Weblink
		3½" TouchFlow	10.105.668.00	1'691.- > Weblink

Accessory

Optional accessories



> Weblink
40.000.912.00 / CHF 106.-
Colander, perforated



> Weblink
40.001.289.00 / CHF 106.-
Colander, unperforated



> Weblink
40.000.909.00 / CHF 151.-
Chopping board, made of glass, white



> Weblink
40.001.277.00 / CHF 151.-
Chopping board, made of plastic

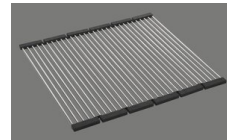

> Weblink
40.001.138.00 / CHF 125.-
Inox Pad

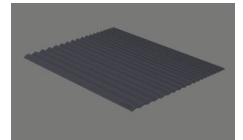

> Weblink
40.002.008.00 / CHF 51.-
Maro dish drainer mat, Dark Grey

Spares

You can find the compatible range of spares here [> Weblink](#)



Für 12mm Arbeitsplatte.
 Pour plan de travail de 12mm.
 Per piano di lavoro da 12mm.

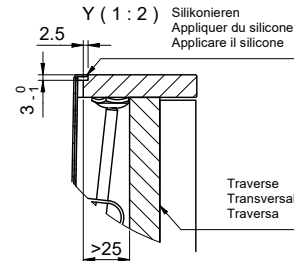
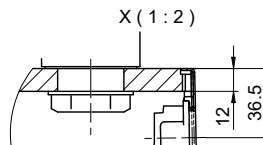

Für 13 - 30mm Arbeitsplatte.
 Pour plan de travail de 13 - 30mm.
 Per piano di lavoro da 13 - 30mm.

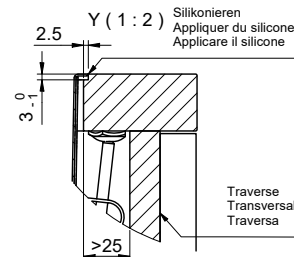
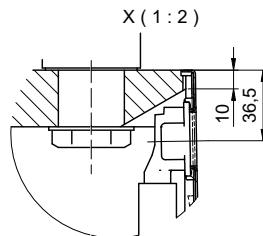

Für 13 - 50mm Arbeitsplatte.
 Pour plan de travail de 13 - 50mm.
 Per piano di lavoro da 13 - 50mm.

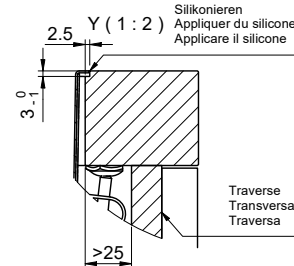
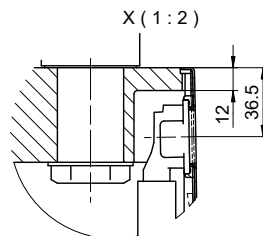

Bei der Planung die Traverse im Möbel beachten!

Faites attention à la barre transversale dans les meubles lors de la planification!

Presta attenzione alla traversa nei mobili durante la pianificazione!

Vom flächenbündigen Einbau in beschichtete Spanplatten raten wir ab.

Nous vous déconseillons le montage à fleur sur des panneaux de particules enduits.

Sconsigliamo il montaggio a filo top in pannelli di truciolato laminato.

Linero LIO 50F/7 Desino

Ausschnitt für flächenbündigen Einbau - Randbreite 7mm:
Mesure de coupure pour montage à fleur - Bord de 7mm de largeur:
Intaglio per montaggio a filo top - Larghezza bordo 7mm:

Bohrung für Zug- und Druckknöpfe Ø14
 Bohrung für Drehknopf Ø25

Trou pour boutons et Poussoirs de commande Ø14
 Trou pour bouton rotatif Ø25

Foro per Pomelli tiranti e Pomelli pulsanti Ø14
 Foro per Pomolo girevoli Ø25



min. 60mm bei stehender Traverse.
 min. 80mm bei liegender Traverse.

min. 60mm avec traverse debout.
 min. 80mm avec traverse allongé.

min. 60mm con traversa stante.
 min. 80mm con traversa coricata.

Für 12mm Arbeitsplatte.
 Pour plan de travail de 12mm.
 Per piano di lavoro da 12mm.



A-A (1 : 2)



Für 13 - 30mm Arbeitsplatte.
 Pour plan de travail de 13 - 30mm.
 Per piano di lavoro da 13 - 30mm.



A-A (1 : 2)



Für 13 - 50mm Arbeitsplatte.
 Pour plan de travail de 13 - 50mm.
 Per piano di lavoro da 13 - 50mm.



A-A (1 : 2)

