

Linero LIO 55F/7

[> Web link](#)



Cabinet size 55 cm

Fitting style
Flushmount sinks

Model
LIO 55F/7

Material
Stainless steel 18/10

Article no.
10.106.245.00

Cabinet size
55 cm

Basket
3½" Space-saving

Surface
Matt

Price CHF
1'644.- excl. VAT

Dimensions
550x400x175mm

Corner radius
15 mm

Overflow and drain technology



Sieve - type M



Swivelling overflow cap

Basket pre-assembly
Basket pre-assembly ex works

Dispenser - mounting option
Free choice of positioning

Overflow and drain technology
Standard push knob



Push knob, chrome

Prices (as of 15.05.26/excl. VAT)

Model	Material	Basket	Article no.	Price CHF
Linero LIO 55F/7	Stainless steel 18/10, Matt	3½" Tipo	10.105.674.00	1'558.- > Weblink
		3½" Space-saving	10.105.673.00	1'599.- > Weblink
		3½" Space-saving	10.106.245.00	1'644.- > Weblink
		3½" TouchFlow	10.105.672.00	1'797.- > Weblink

Accessory

Optional accessories



> Weblink
40.000.912.00 / CHF 106.-
Colander, perforated



> Weblink
40.001.289.00 / CHF 106.-
Colander, unperforated

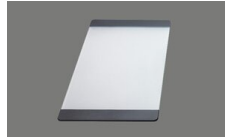

> Weblink
40.000.909.00 / CHF 151.-
Chopping board, made of glass, white



> Weblink
40.001.277.00 / CHF 151.-
Chopping board, made of plastic

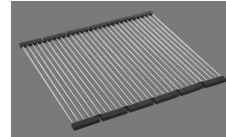

> Weblink
40.001.138.00 / CHF 125.-
Inox Pad

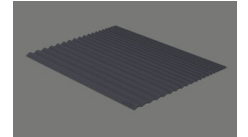

> Weblink
40.002.008.00 / CHF 51.-
Maro dish drainer mat, Dark Grey

Spares

You can find the compatible range of spares here [> Weblink](#)

Linero LIO 55F/7 Desino

Randbreite 7mm
 Bord de 7mm de largeur
 Larghezza bordo 7mm

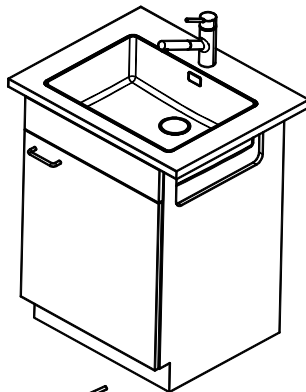
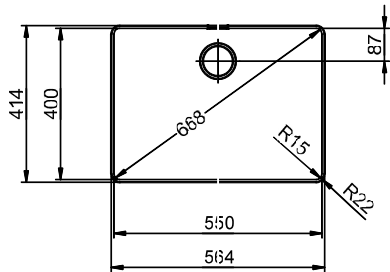

Für 12mm Arbeitsplatte.
 Pour plan de travail de 12mm.
 Per piano di lavoro da 12mm.

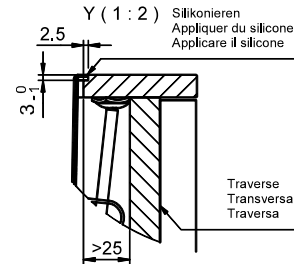
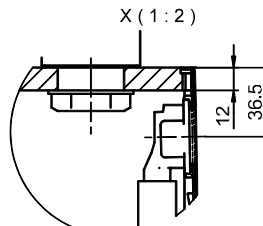

Für 13 - 30mm Arbeitsplatte.
 Pour plan de travail de 13 - 30mm.
 Per piano di lavoro da 13 - 30mm.

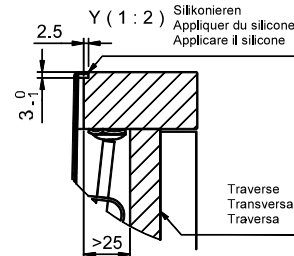
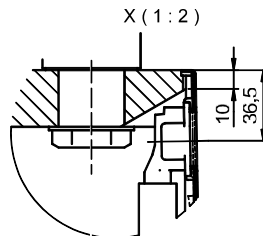

Für 13 - 50mm Arbeitsplatte.
 Pour plan de travail de 13 - 50mm.
 Per piano di lavoro da 13 - 50mm.

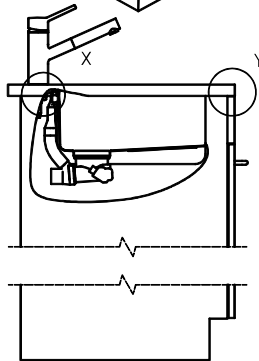
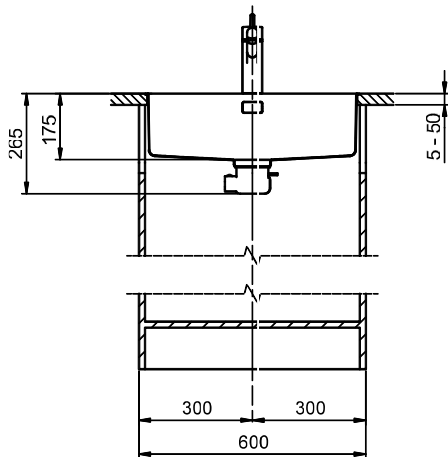
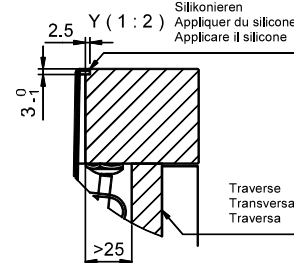
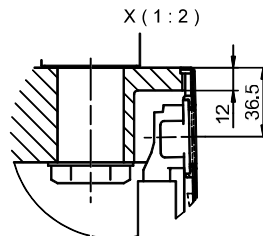

Bei der Planung die Traverse im Möbel beachten!

Faites attention à la barre transversale dans les meubles lors de la planification!

Presta attenzione alla traversa nei mobili durante la pianificazione!

Vom flächenbündigen Einbau in beschichtete Spanplatten raten wir ab.

Nous vous déconseillons le montage à fleur sur des panneaux de particules enduits.

Sconsigliamo il montaggio a filo top in pannelli di truciolato laminato.

Linero LIO 55F/7 Desino

Ausschnitt für flächenbündigen Einbau - Randbreite 7mm:
 Mesure de coupure pour montage à fleur - Bord de 7mm de largeur:
 Intaglio per montaggio a filo top - Larghezza bordo 7mm:

Bohrung nur für externe Ventili-Bedienung:
 Perçage uniquement pour une utilisation externe de la soupape:
 Foratura solo per uso esterno della piletta:

Zugknopf / bouton de commande / pomolo: Ø14
 Drehknopf / bouton rotatif / pomolo girevole: Ø25
 Druckknopf / bouton-poussoir / pulsante: Ø35

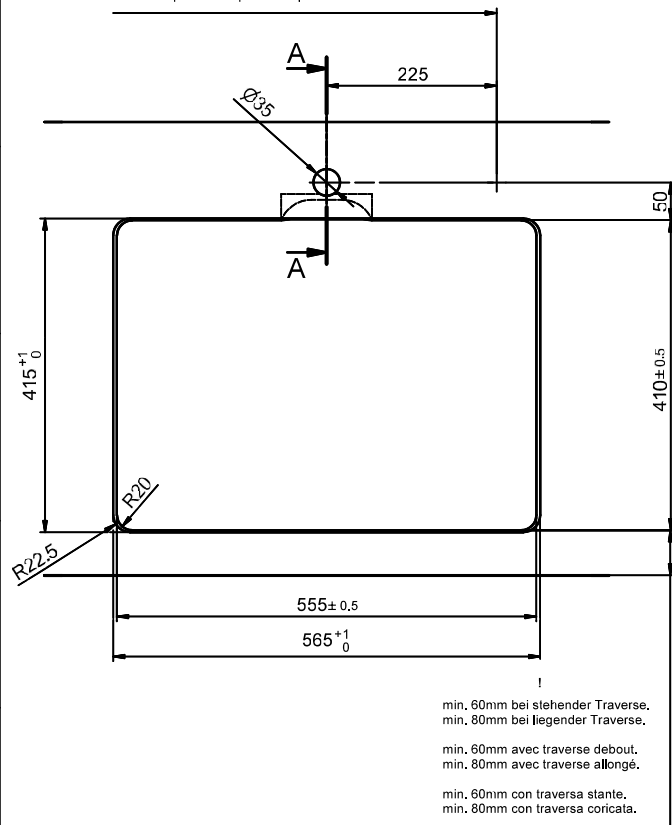

Für 12mm Arbeitsplatte.
 Pour plan de travail de 12mm.
 Per piano di lavoro da 12mm.

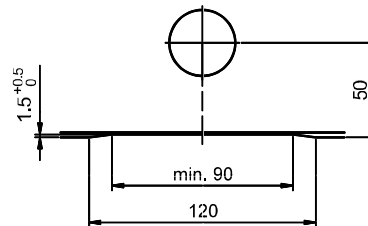

A-A (1 : 2)

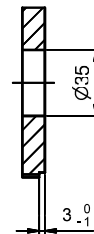

Für 13 - 30mm Arbeitsplatte.
 Pour plan de travail de 13 - 30mm.
 Per piano di lavoro da 13 - 30mm.

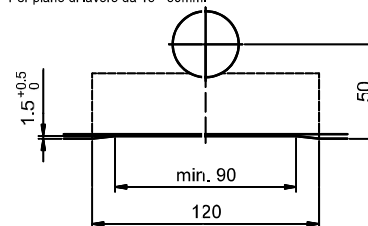

A-A (1 : 2)

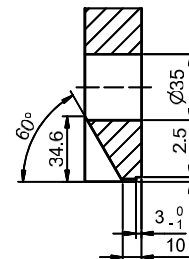

Für 13 - 50mm Arbeitsplatte.
 Pour plan de travail de 13 - 50mm.
 Per piano di lavoro da 13 - 50mm.

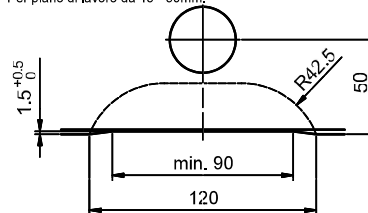

A-A (1 : 2)

