

Silver Star SIL 45IF/12
[> Web link](#)

Fitting style
Flushmount sinks / Flat-mount inset

Model
SIL 45IF/12

Material
Stainless steel 18/10

Article no.
10.104.256.00

Cabinet size
50 cm

Basket
3½" Tipo

Surface
Matt

Price CHF
896.- excl. VAT

Dimensions
450x420x175mm

Corner radius
50 mm

Overflow and drain technology

Sieve - type S



Concealed overflow

Basket pre-assembly
Assembly of the valve at the factory

Dispenser - mounting option
Free choice of positioning

Overflow and drain technology
Standard pull-up knob



Prime

Prices (as of 07.05.26/excl. VAT)

Model	Material	Basket	Article no.	Price CHF
Silver Star SIL 45IF/12	Stainless steel 18/10, Matt	3½" Tipo	10.104.256.00	896.- > Weblink
		3½" Space-saving	10.104.255.00	937.- > Weblink

Product description
Delivery from 1.3.22 with edge width 12 mm

With delivery from 1.3.2022, this model has an edge width of 12mm. Please note the changed cut-out dimensions.

1 Product design, 2 mounting types

The special advantage of IF models: Both flush and flat installation is possible.

Flush-mounted installation: Recommendation for the choice of worktop:

We recommend installation in worktops made of granite, artificial stone (e.g. Corian or Varicor) or solid wood. We do not recommend installation in synthetic resin worktops.

Accessory

Optional accessories



> Weblink
40.000.914.00 / CHF
106.-
Colander, perforated



> Weblink
40.001.290.00 / CHF
106.-
Colander, unperforated



> Weblink
40.000.915.00 / CHF
151.-
Chopping board, made of
glass, white



> Weblink
40.001.147.00 / CHF
151.-
Chopping board, made of
wood

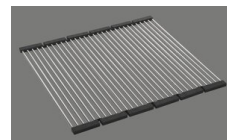

> Weblink
40.001.138.00 / CHF
125.-
Inox Pad

Compatible Articles

> Weblink
40.001.314.00 / CHF
155.-
Dispenser Nano



> Weblink
40.001.023.00 / CHF
347.-
Müllex Boxx 40-R

Silver Star SIL 45IF/12 > Web link

Spares

You can find the compatible range of spares here > [Weblink](#)

Siver Star SIL 451F/12

Randbreite 12mm
Bord de 12mm de largeur
Larghezza bordo 12mm

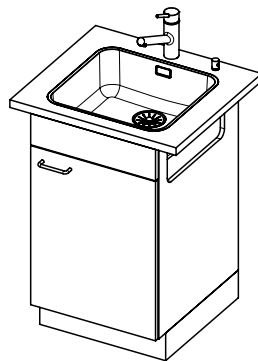
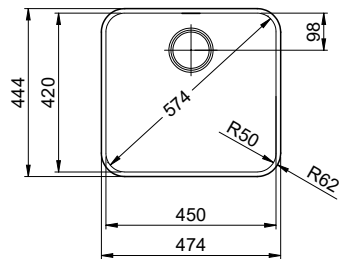

Für 12mm Arbeitsplatte.
 Pour plan de travail de 12mm.
 Per piano di lavoro da 12mm.

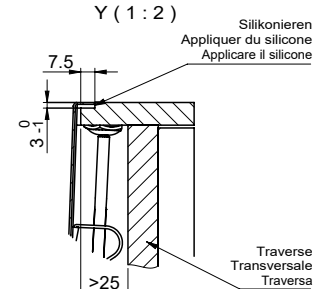
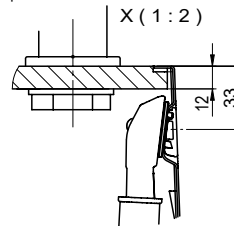

Für 13 - 30mm Arbeitsplatte.
 Pour plan de travail de 13 - 30mm.
 Per piano di lavoro da 13 - 30mm.

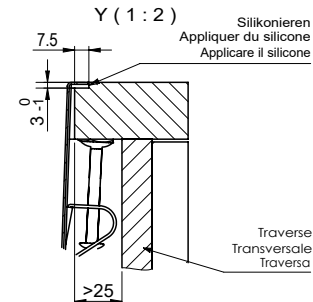
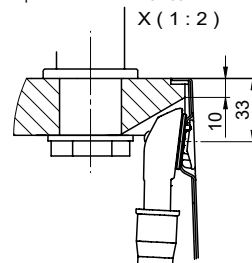

Für 13 - 50mm Arbeitsplatte.
 Pour plan de travail de 13 - 50mm.
 Per piano di lavoro da 13 - 50mm.

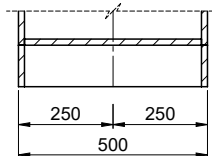
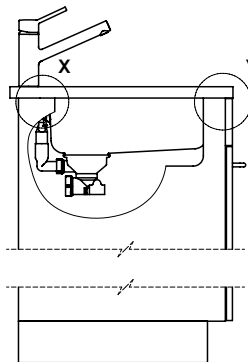
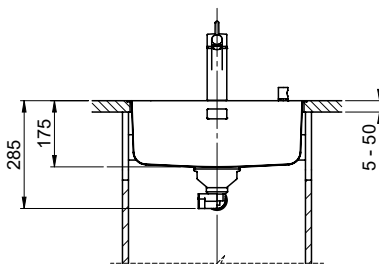
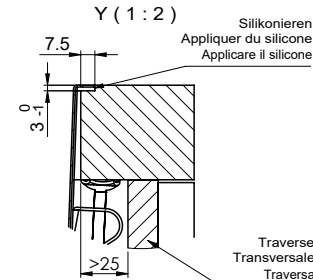
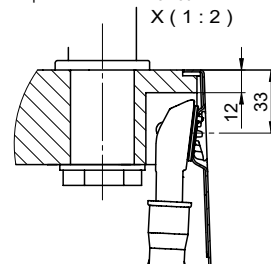

Bei der Planung die Traverse im Möbel beachten!

Faites attention à la barre transversale dans les meubles lors de la planification!

Presta attenzione alla traversa nei mobili durante la pianificazione!

Vom flächenbündigen Einbau in beschichteten Spanplatten raten wir ab.

Nous vous déconseillons le montage à fleur sur des panneaux de particules enduits.

Sconsigliamo il montaggio a filo top in pannelli di truciolato laminato.

Silver Star SIL 45IF/12

Ausschnitt für flächenbündigen Einbau - Randbreite 12mm:
 Mesure de coupe pour montage à fleur - Bord de 12mm de largeur:
 Intaglio per montaggio a filo top - Larghezza bordo 12mm:

Bohrung für Zug- und Druckknöpfe ø14
 Bohrung für Drehknopf ø25

Trou pour boutons et Pousoirs de commande ø14
 Trou pour bouton rotatif ø25

Foro per Pomelli tiranti e Pomelli pulsanti ø14
 Foro per Pomolo girevoli ø25

Für 12mm Arbeitsplatte.
 Pour plan de travail de 12 mm.
 Per piano di lavoro da 12 mm.

A-A (1 : 2)

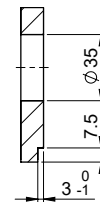
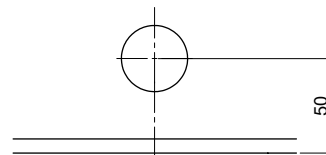

Für 13 - 30mm Arbeitsplatte.
 Pour plan de travail de 13 - 30mm.
 Per piano di lavoro da 13 - 30mm.

A-A (1 : 2)

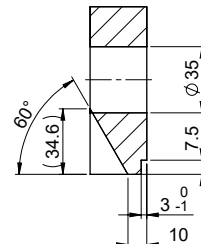
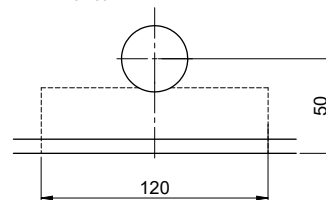

Für 13 - 50mm Arbeitsplatte.
 Pour plan de travail de 13 - 50mm.
 Per piano di lavoro da 13 - 50mm.

A-A (1 : 2)

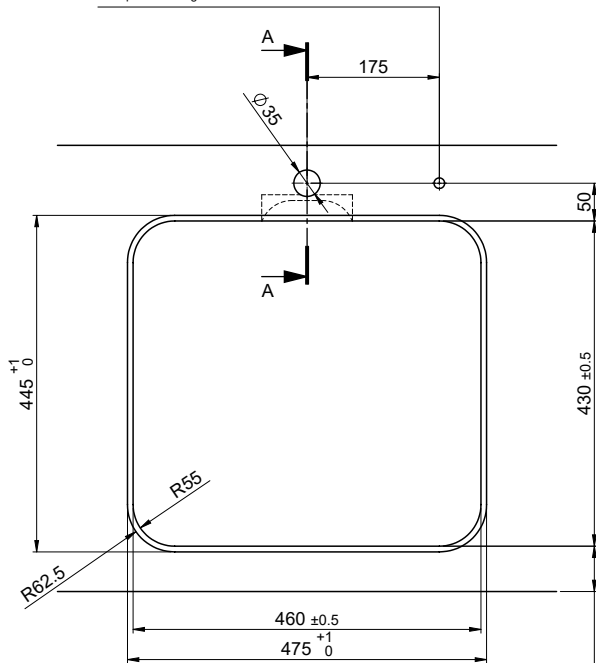
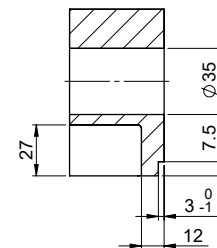
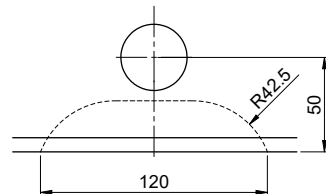

min. 60mm bei stehender Traverse
 min. 80mm bei liegender Traverse

min. 60mm avec traverse debout
 min. 80mm avec traverse allongé

min. 60mm con traversa stante
 min. 80mm con traversa coricata

Bohrung für Zug- und Druckknöpfe ø14

Bohrung für Drehknopf ø25

Trou pour boutons et Pousoirs de commande ø14

Trou pour bouton rotatif ø25

Foro per Pomelli tiranti e Pomelli pulsanti ø14

Foro per Pomolo girevoli ø25

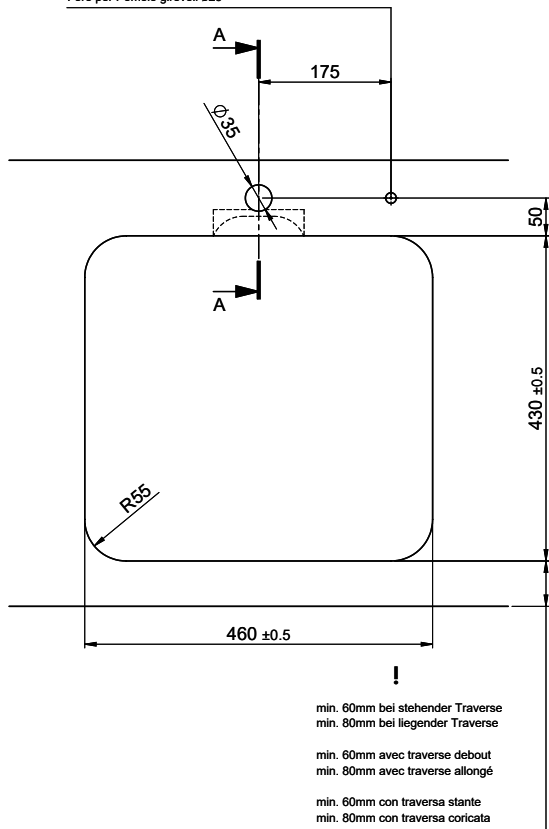

Für 12mm Arbeitsplatte.
 Pour plan de travail de 12 mm.
 Per piano di lavoro da 12 mm.

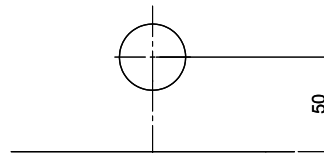

A-A (1 : 2)

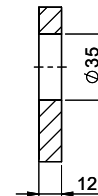

Für 13 - 30mm Arbeitsplatte.
 Pour plan de travail de 13 - 30mm.
 Per piano di lavoro da 13 - 30mm.

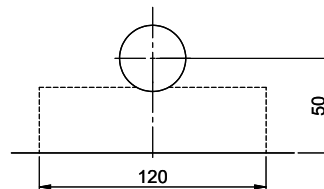

A-A (1 : 2)

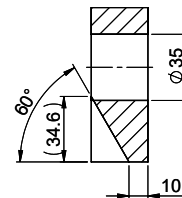

Für 13 - 50mm Arbeitsplatte.
 Pour plan de travail de 13 - 50mm.
 Per piano di lavoro da 13 - 50mm.

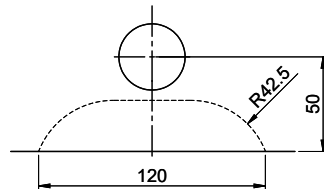

A-A (1 : 2)

