

Silver Star SIS 50IF/12

[> Web link](#)



Fitting style
Flushmount sinks / Flat-mount inset

Model
SIS 50IF/12

Material
Stainless steel 18/10

Article no.
10.104.263.00

Cabinet size
55 cm

Basket
3½" Space-saving

Surface
Matt

Price CHF
1'050.- excl. VAT

Dimensions
500x420x175mm

Corner radius
50 mm

Overflow and drain technology



Sieve - type S



Concealed overflow

Basket pre-assembly
Assembly of the valve at the factory

Dispenser - mounting option
Free choice of positioning

Overflow and drain technology
Standard pull-up knob



Prime

Prices (as of 09.05.26/excl. VAT)

Model	Material	Basket	Article no.	Price CHF
Silver Star SIS 50IF/12	Stainless steel 18/10, Matt	3½" Tipo	10.104.264.00	1'009.- > Weblink
		3½" Space-saving	10.104.263.00	1'050.- > Weblink

Product description

Delivery from 1.3.22 with edge width 12 mm

With delivery from 1.3.2022, this model has an edge width of 12mm. Please note the changed cut-out dimensions.

1 Product design, 2 mounting types

The special advantage of IF models: Both flush and flat installation is possible.

Flush-mounted installation: Recommendation for the choice of worktop:

We recommend installation in worktops made of granite, artificial stone (e.g. Corian or Varicor) or solid wood. We do not recommend installation in synthetic resin worktops.

Accessory

Optional accessories



[> Weblink](#)
40.000.914.00 / CHF
106.-
Colander, perforated



[> Weblink](#)
40.001.290.00 / CHF
106.-
Colander, unperforated

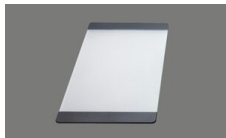

[> Weblink](#)
40.000.915.00 / CHF
151.-
Chopping board, made of
glass, white

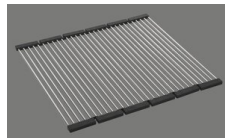

[> Weblink](#)
40.001.138.00 / CHF
125.-
Inox Pad



[> Weblink](#)
40.001.147.00 / CHF
151.-
Chopping board, made of
wood

Compatible Articles



[> Weblink](#)
40.001.314.00 / CHF
155.-
Dispenser Nano



[> Weblink](#)
40.001.024.00 / CHF
427.-
Müllex Boxx 55/60-R Bio

Silver Star SIS 50IF/12 > [Web link](#)

Spares

You can find the compatible range of spares here > [Weblink](#)

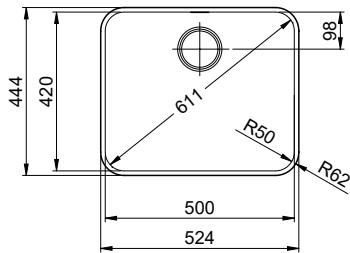

Für 12mm Arbeitsplatte.
 Pour plan de travail de 12mm.
 Per piano di lavoro da 12mm.

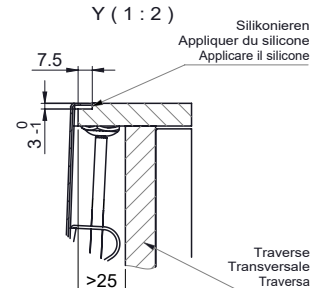
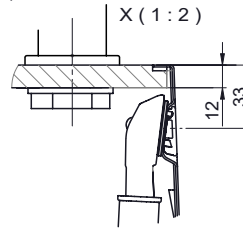

Für 13 - 30mm Arbeitsplatte.
 Pour plan de travail de 13 - 30mm.
 Per piano di lavoro da 13 - 30mm.

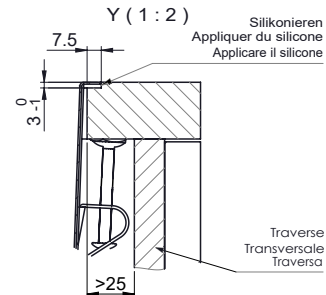
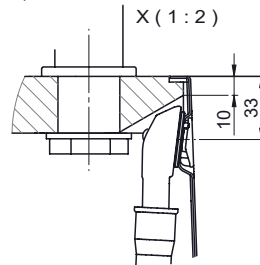

Für 13 - 50mm Arbeitsplatte.
 Pour plan de travail de 13 - 50mm.
 Per piano di lavoro da 13 - 50mm.

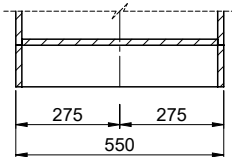
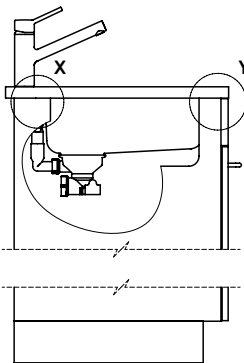
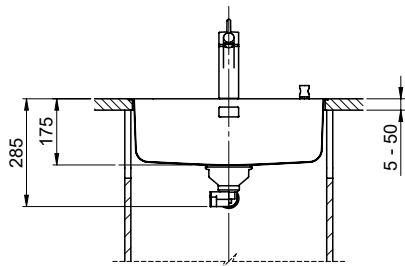
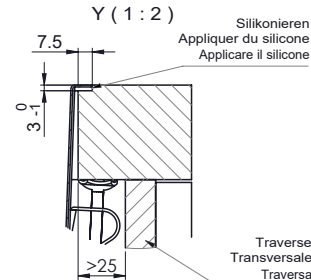
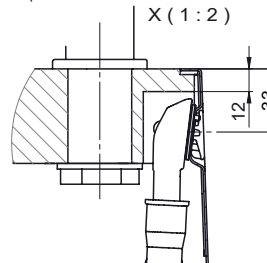

Bei der Planung die Traverse im Möbel beachten!

Faites attention à la barre transversale dans les meubles lors de la planification!

Presta attenzione alla traversa nei mobili durante la pianificazione!

Vom flächenbündigen Einbau in beschichteten Spanplatten raten wir ab.

Nous vous déconseillons le montage à fleur sur des panneaux de particules enduits.

Sconsigliamo il montaggio a filo top in pannelli di truciolato laminato.

Bohrung für Zug- und Druckknöpfe ø14
 Bohrung für Drehknopf ø25

Trou pour boutons et Pouissoirs de commande ø14
 Trou pour bouton rotatif ø25

Foro per Pomelli tiranti e Pomelli pulsanti ø14
 Foro per Pomolo girevoli ø25

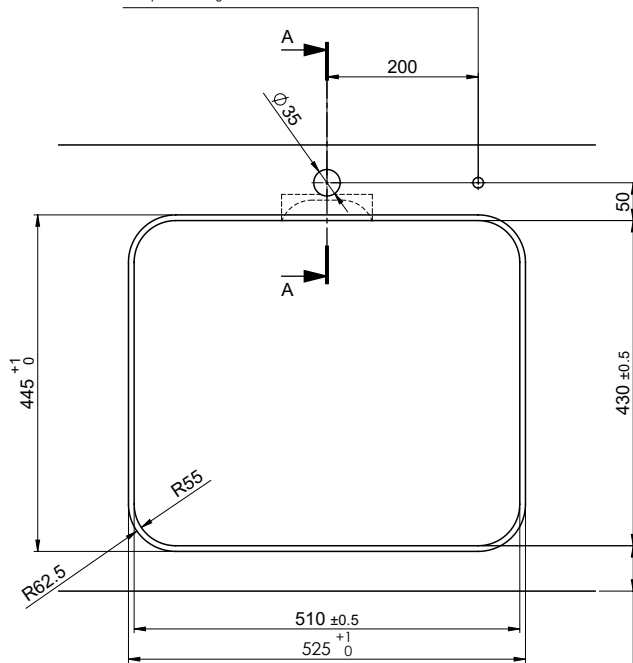

min. 60mm bei stehender Traverse
 min. 80mm bei liegender Traverse

min. 60mm avec traverse debout
 min. 80mm avec traverse allongé

min. 60mm con traversa stante
 min. 80mm con traversa coricata

Für 12mm Arbeitsplatte.
 Pour plan de travail de 12 mm.
 Per piano di lavoro da 12 mm.

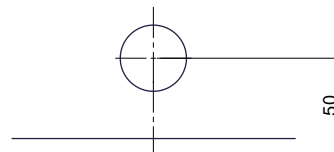

A-A (1 : 2)

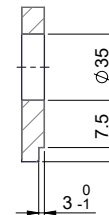

Für 13 - 30mm Arbeitsplatte.
 Pour plan de travail de 13 - 30mm.
 Per piano di lavoro da 13 - 30mm.

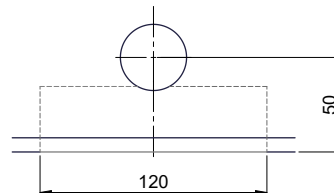

A-A (1 : 2)

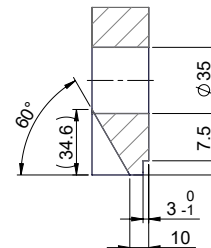

Für 13 - 50mm Arbeitsplatte.
 Pour plan de travail de 13 - 50mm.
 Per piano di lavoro da 13 - 50mm.

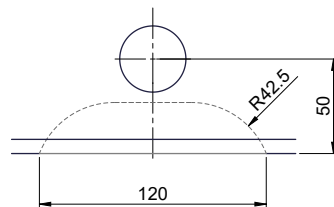

A-A (1 : 2)

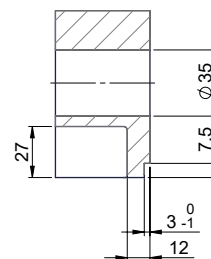

Bohrung für Zug- und Druckknöpfe ø14
 Bohrung für Drehknopf ø25

Trou pour boutons et Pousoirs de commande ø14
 Trou pour bouton rotatif ø25

Foro per Pomelli tiranti e Pomelli pulsanti ø14
 Foro per Pomolo girevoli ø25

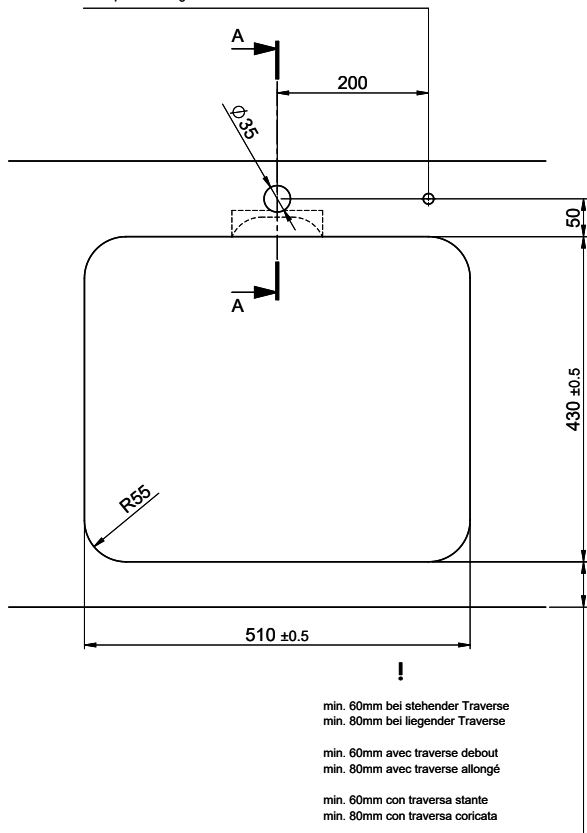

Für 12mm Arbeitsplatte.
 Pour plan de travail de 12 mm.
 Per piano di lavoro da 12 mm.

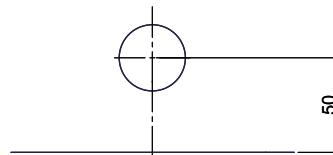

A-A (1 : 2)

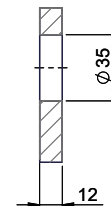

Für 13 - 30mm Arbeitsplatte.
 Pour plan de travail de 13 - 30mm.
 Per piano di lavoro da 13 - 30mm.

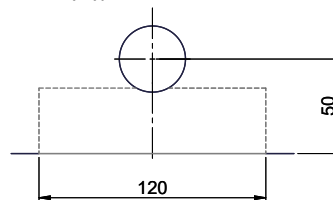

A-A (1 : 2)

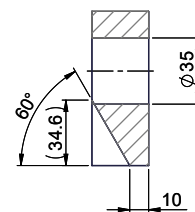

Für 13 - 50mm Arbeitsplatte.
 Pour plan de travail de 13 - 50mm.
 Per piano di lavoro da 13 - 50mm.

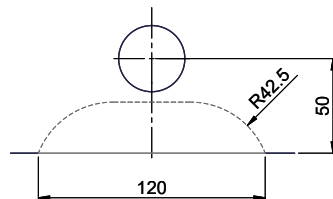

A-A (1 : 2)

