

Vantis VG 50-42IF/12 Green

[> Web link](#)



Cabinet size 55 cm

Fitting style
Flushmount sinks / Flat-mount inset

Model
VG 50-42IF/12 Green

Material
Stainless steel 18/10

Article no.
10.105.782.00

Cabinet size
55 cm

Basket
3½" Space-saving

Surface
Matt

Price CHF
1'098.- excl. VAT

Dimensions
500x420x160mm

Corner radius
35 mm

Overflow and drain technology



Sieve - type S



Swivelling overflow cap

Basket pre-assembly
Assembly of the valve at the factory

Dispenser - mounting option
Free choice of positioning

Green Line



Green Line is an independent product version geared towards sustainability.

Standard



Advant

Prices (as of 22.06.26/excl. VAT)

Model	Material	Basket	Article no.	Price CHF	
Vantis VG 50-42IF/12 Green	Stainless steel 18/10, Matt	3½" Tipo	10.105.783.00	1'049.-	> Weblink
		3½" TouchFlow	10.105.781.00	1'296.-	> Weblink
		3½" Space-saving	10.105.782.00	1'098.-	> Weblink

Accessory

Optional accessories



[> Weblink](#)
40.000.914.00 / CHF
106.-
Colander, perforated



[> Weblink](#)
40.001.290.00 / CHF
106.-
Colander, unperforated

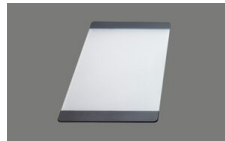

[> Weblink](#)
40.000.915.00 / CHF
151.-
Chopping board, made of glass, white



[> Weblink](#)
40.001.147.00 / CHF
151.-
Chopping board, made of wood

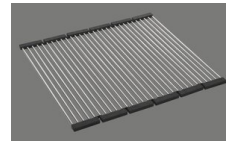

[> Weblink](#)
40.001.138.00 / CHF
125.-
Inox Pad

Spares

You can find the compatible range of spares here [> Weblink](#)

Vantis VG 50-42IF/12 Green

Randbreite 12mm
Bord de 12mm de largeur
Larghezza bordo 12mm

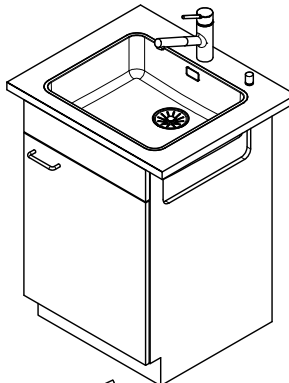
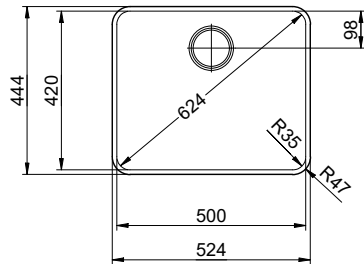

Für 12mm Arbeitsplatte.
 Pour plan de travail de 12mm.
 Per piano di lavoro da 12mm.

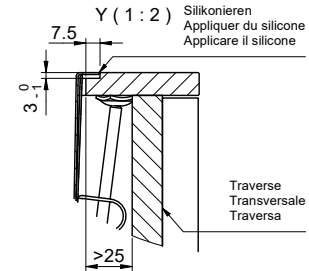
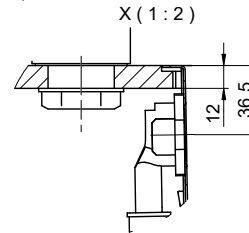

Für 13 - 30mm Arbeitsplatte.
 Pour plan de travail de 13 - 30mm.
 Per piano di lavoro da 13 - 30mm.

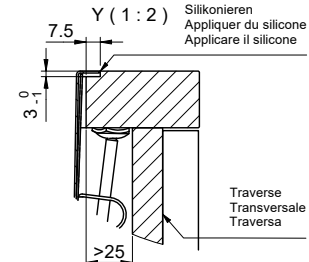
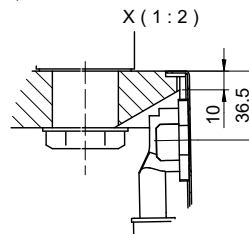

Für 13 - 50mm Arbeitsplatte.
 Pour plan de travail de 13 - 50mm.
 Per piano di lavoro da 13 - 50mm.

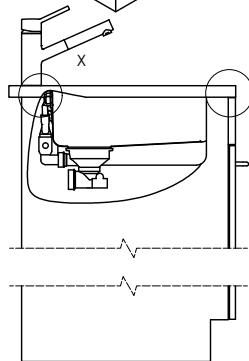
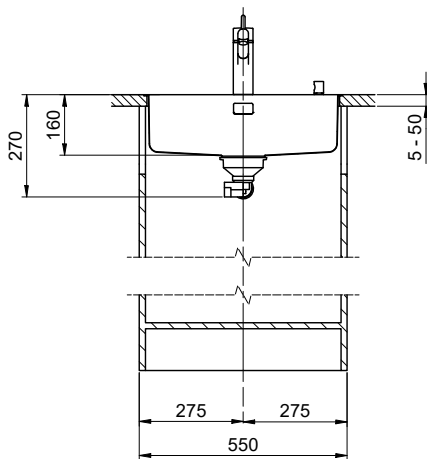
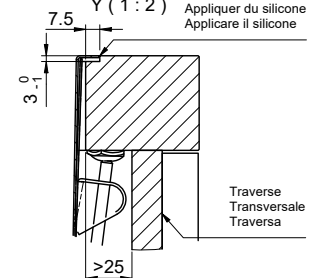
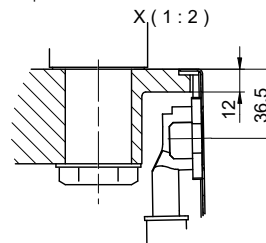

Bei der Planung die Traverse im Möbel beachten!

Faites attention à la barre transversale dans les meubles lors de la planification!

Presta attenzione alla traversa nei mobili durante la pianificazione!

Vom flächenbündigen Einbau in beschichtete Spanplatten raten wir ab.

Nous vous déconseillons le montage à fleur sur des panneaux de particules enduits.

Sconsigliamo il montaggio a filo top in pannelli di truciolato laminato.

Vantis VG 50-42IF/12 Green

Ausschnitt für flächenbündigen Einbau - Randbreite 12mm:
Mesure de coupure pour montage à fleur - Bord de 12mm de largeur:
Intaglio per montaggio a filo top - Larghezza bordo 12mm:

Bohrung für Zug- und Druckknöpfe Ø14
 Bohrung für Drehknopf Ø25

Trou pour boutons et Poussoirs de commande Ø14
 Trou pour bouton rotatif Ø25

Foro per Pomelli tiranti e Pomelli pulsanti Ø14
 Foro per Pomolo girevoli Ø25

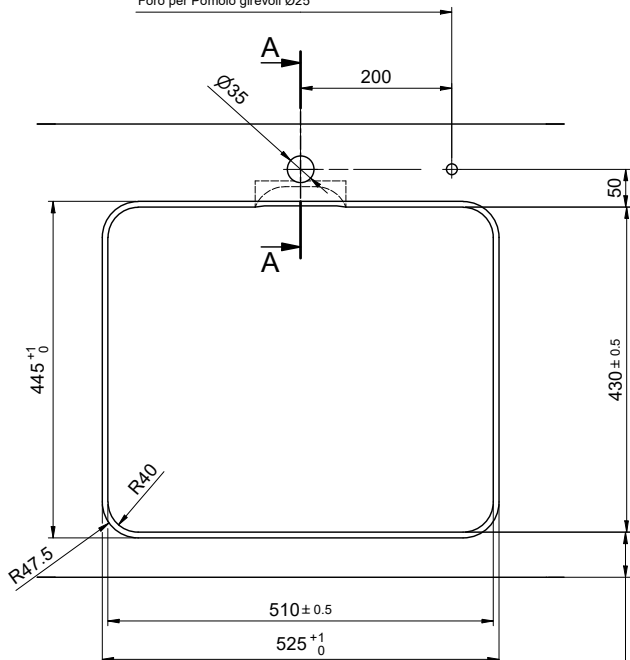

min. 60mm bei stehender Traverse.
 min. 80mm bei liegender Traverse.

min. 60mm avec traverse debout.
 min. 80mm avec traverse allongé.

min. 60mm con traversa stante.
 min. 80mm con traversa coricata.

Für 12mm Arbeitsplatte.
 Pour plan de travail de 12mm.
 Per piano di lavoro da 12mm.

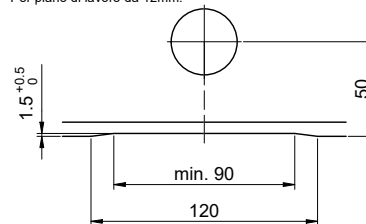

A-A (1 : 2)

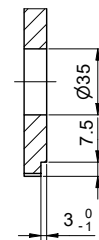

Für 13 - 30mm Arbeitsplatte.
 Pour plan de travail de 13 - 30mm.
 Per piano di lavoro da 13 - 30mm.

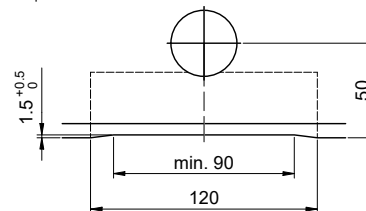

A-A (1 : 2)

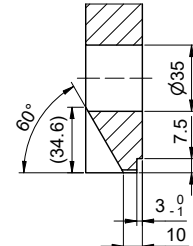

Für 13 - 50mm Arbeitsplatte.
 Pour plan de travail de 13 - 50mm.
 Per piano di lavoro da 13 - 50mm.

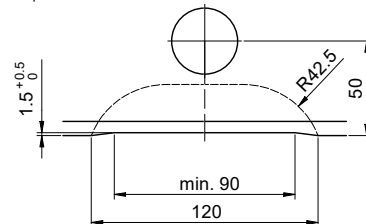

A-A (1 : 2)

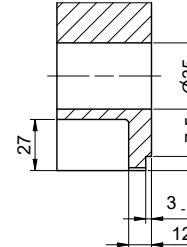

Vantis VG 50-42IF/12 Green

Ausschnitt für flach aufliegenden Einbau - Randbreite 12mm:
Mesure de coupure pour montage en appui - Bord de 12mm de largeur:
Intaglio per montaggio soprapiano - Larghezza bordo 12mm:

Bohrung für Zug- und Druckknöpfe Ø14
 Bohrung für Drehknopf Ø25

Trou pour boutons et Poussoirs de commande Ø14
 Trou pour bouton rotatif Ø25

Foro per Pomelli tiranti e Pomelli pulsanti Ø14
 Foro per Pomolo girevoli Ø25

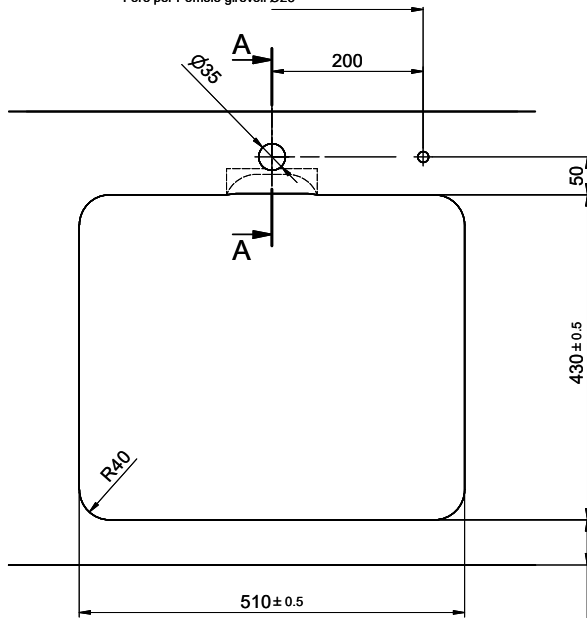

min. 60mm bei stehender Traverse.
 min. 80mm bei liegender Traverse.

min. 60mm avec traverse debout.
 min. 80mm avec traverse allongé.

min. 60mm con traversa stante.
 min. 80mm con traversa coricata.

Für 12mm Arbeitsplatte.
 Pour plan de travail de 12mm.
 Per piano di lavoro da 12mm.



A-A (1 : 2)

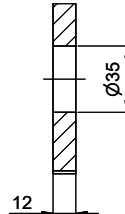

Für 13 - 30mm Arbeitsplatte.
 Pour plan de travail de 13 - 30mm.
 Per piano di lavoro da 13 - 30mm.

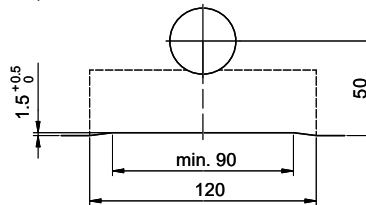

A-A (1 : 2)

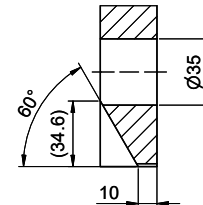

Für 13 - 50mm Arbeitsplatte.
 Pour plan de travail de 13 - 50mm.
 Per piano di lavoro da 13 - 50mm.

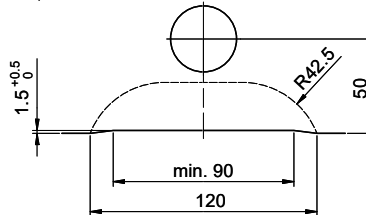

A-A (1 : 2)

