

Linero LIO 45F/7
[> Lien web](#)

Type de montage

Éviers affleuré

Modèle

LIO 45F/7

Matériel

Acier inox 18/10

No. d'article

10.105.665.00

Élément inférieur

50 cm

Soupape

3½" Extra plate

Finition

Brossé

Prix en CHF

1'465.- hors TVA

Dimensions d'évier

450x400x175mm

Rayons d'angle

15 mm

Technologie de vidage et de trop-plein

Grille - type M



Plaque de trop-plein basculante

Pré-montage du soupape

Pré-montage du soupape en usine

Distributeur - option de montage

Libre choix de positionnement

Technologie de vidage et de trop-plein
Bouton de commande y

Advant

Prix (au 21.06.26 / TVA non incl.)

Modèle	Matériel	Soupape	No. d'article	Prix en CHF
Linero LIO 45F/7	Acier inox 18/10, Brossé	3½" Tipo	10.105.666.00	1'424.- > Weblink
		3½" Extra plate	10.105.665.00	1'465.- > Weblink
		3½" Extra plate	10.106.243.00	1'510.- > Weblink
		3½" TouchFlow	10.105.664.00	1'663.- > Weblink

Accessoire
Accessoires en option

 > Weblink
 40.000.912.00 / CHF 106.-
 Panier amovible, percé

 > Weblink
 40.001.289.00 / CHF 106.-
 Panier amovible, non percé

 > Weblink
 40.000.909.00 / CHF 151.-
 Planche à découper, en verre, blanc

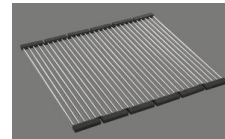
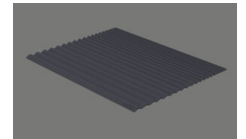
 > Weblink
 40.001.277.00 / CHF 151.-
 Planche à découper, synthétique

 > Weblink
 40.001.138.00 / CHF 125.-
 Inox Pad

 > Weblink
 40.002.008.00 / CHF 51.-
 Maro tapis d'égouttage, Dark Grey

Pièces détachées

 Retrouvez les références accessoires ici > [Weblink](#)

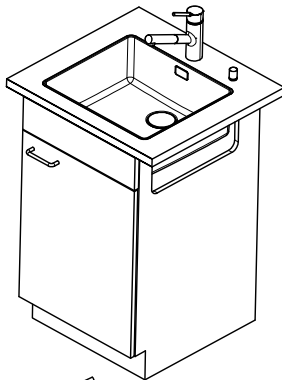
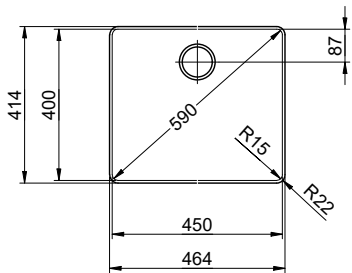
Linero LIO 45F/7 Desino

Randbreite 7mm
 Bord de 7mm de largeur
 Larghezza bordo 7mm



Für 12mm Arbeitsplatte.
 Pour plan de travail de 12mm.
 Per piano di lavoro da 12mm.

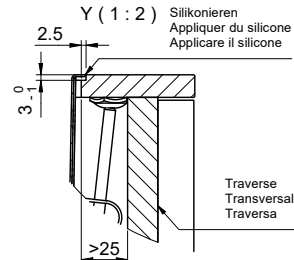
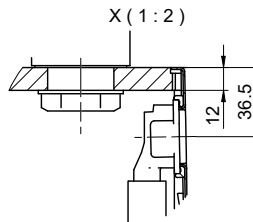

Für 13 - 30mm Arbeitsplatte.
 Pour plan de travail de 13 - 30mm.
 Per piano di lavoro da 13 - 30mm.

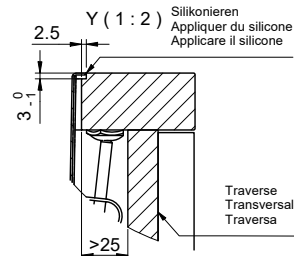
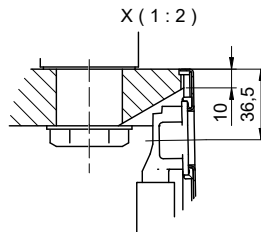

Für 13 - 50mm Arbeitsplatte.
 Pour plan de travail de 13 - 50mm.
 Per piano di lavoro da 13 - 50mm.

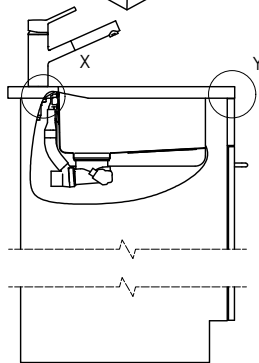
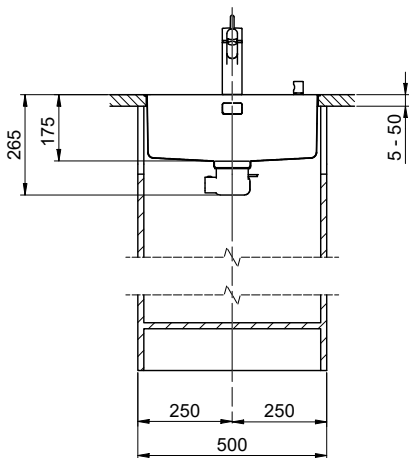
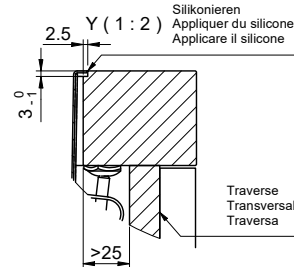
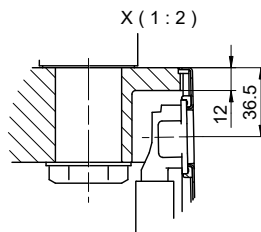

Bei der Planung die Traverse im Möbel beachten!

Faites attention à la barre transversale dans les meubles lors de la planification!

Presta attenzione alla traversa nei mobili durante la pianificazione!

Vom flächenbündigen Einbau in beschichtete Spanplatten raten wir ab.

Nous vous déconseillons le montage à fleur sur des panneaux de particules enduits.

Sconsigliamo il montaggio a filo top in pannelli di truciolato laminato.

Linero LIO 45F/7 Desino

Ausschnitt für flächenbündigen Einbau - Randbreite 7mm:
Mesure de coupure pour montage à fleur - Bord de 7mm de largeur:
Intaglio per montaggio a filo top - Larghezza bordo 7mm:

Bohrung für Zug- und Druckknöpfe Ø14
 Bohrung für Drehknopf Ø25

Trou pour boutons et Pousoirs de commande Ø14
 Trou pour bouton rotatif Ø25

Foro per Pomelli tiranti e Pomelli pulsanti Ø14
 Foro per Pomolo girevoli Ø25



Für 12mm Arbeitsplatte.
 Pour plan de travail de 12mm.
 Per piano di lavoro da 12mm.



A-A (1 : 2)

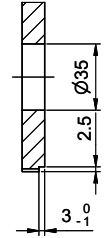

Für 13 - 30mm Arbeitsplatte.
 Pour plan de travail de 13 - 30mm.
 Per piano di lavoro da 13 - 30mm.

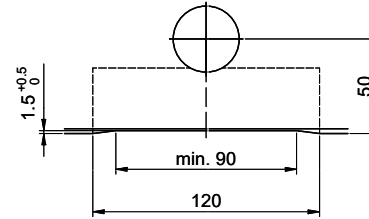

A-A (1 : 2)

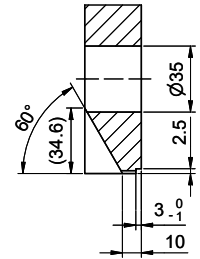

Für 13 - 50mm Arbeitsplatte.
 Pour plan de travail de 13 - 50mm.
 Per piano di lavoro da 13 - 50mm.

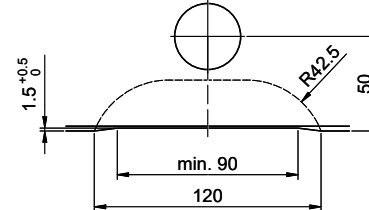

A-A (1 : 2)

