

X50 M35 Basic

Art. n. 80.50.203

Sistema raccolta rifiuti estraibile esistente

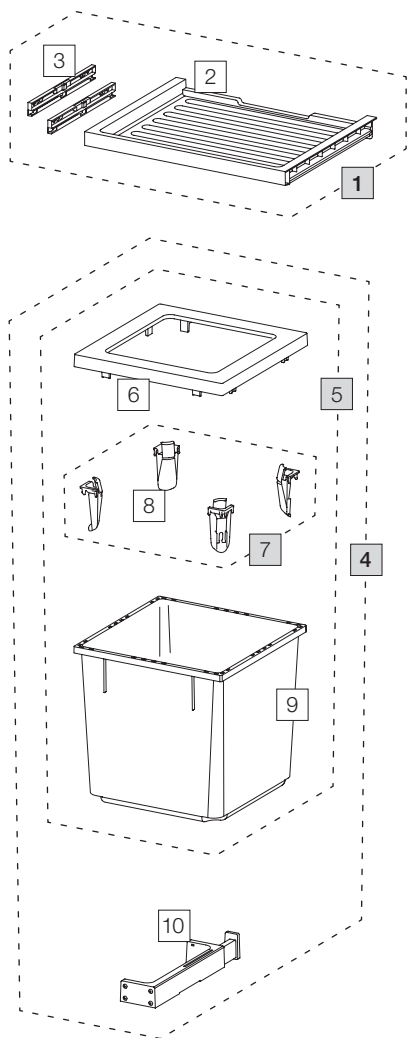

	Art. n.	Denominazione	CHF escl. IVA
1	80.41.201	Cassetto 50 Basic	29.00
2	12287	Cassetto 50 Basic	24.70
3	13011	Adattatore cassetto (coppia)	8.80
4	80.51.102	Contenitori raccolta rifiuti X45 M35	122.00
5	12683	Contenitore 35 litri, completo	83.90
6	12247	Telai o di copertura	17.40
7	12252	Tendisacco piccolo (4 pz.)	16.40
8	12721	Tendisacco	4.10
9	12245	Contenitore 35 litri	52.40
10	12625	Cricchetto C, completo	39.20

 Set

 Componenti singoli