

Accento A 40IF/12

> Weblink



Montaggio
Lavelli a filo top / Lavelli sopraiano

Modello
A 40IF/12

Materiale
Acciaio inox 18/10

N. di articolo
10.104.536.00

Dimensioni base
45 cm

Piletta
3½" Tipo

Finitura
Lucido

Prezzo in CHF
1'318.- IVA esclusa

Dimensioni lavello
400x400x175mm

Raggi d'angolo
12 mm

Tecnologia di scarico e troppopieno

Tecnologia di scarico e troppopieno



Griglietta - tipo S



Placchetta di troppopieno a ribalta

Prezzi (aggiornati al 29.06.26 / IVA esclusa)

Modello	Materiale	Piletta	N. di articolo	Prezzo in CHF
Accento A 40IF/12	Acciaio inox 18/10, Lucido	3½" Tipo	10.104.536.00	1'318.- > Weblink

Accessorio

Accessori opzionali



> Weblink
40.000.912.00 / CHF 106.-
Vaschetta, forato



> Weblink
40.001.289.00 / CHF 106.-
Vaschetta, non forato



> Weblink
40.000.909.00 / CHF 151.-
Tagliere, in vetro, bianco



> Weblink
40.001.277.00 / CHF 151.-
Tagliere, sintetico

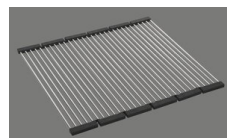

> Weblink
40.001.138.00 / CHF 125.-
Inox Pad

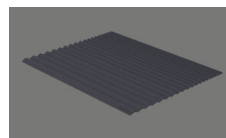

> Weblink
40.002.008.00 / CHF 51.-
Maro tappetino scolapiatti, Dark Grey

Accento A 40IF/12 sFlow Typ S

Randbreite 12mm
Bord de 12mm de largeur
Larghezza bordo 12mm

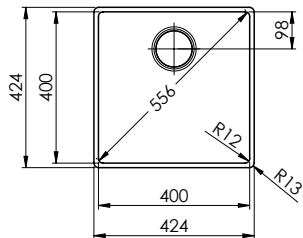

Für 12mm Arbeitsplatte.
 Pour plan de travail de 12mm.
 Per piano di lavoro da 12mm.

X (1:2)

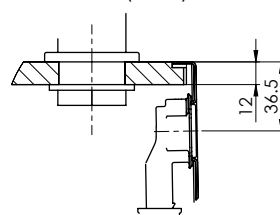

Y (1:2)

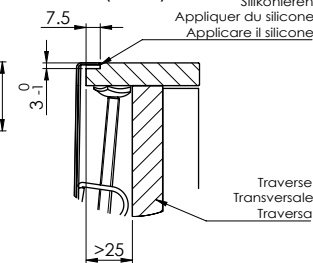

Für 13 - 30mm Arbeitsplatte.
 Pour plan de travail de 13 - 30mm.
 Per piano di lavoro da 13 - 30mm.

X (1:2)

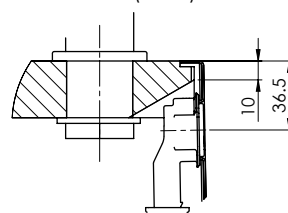

Y (1:2)

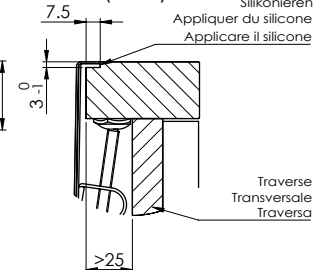

Für 13 - 50mm Arbeitsplatte.
 Pour plan de travail de 13 - 50mm.
 Per piano di lavoro da 13 - 50mm.

X (1:2)

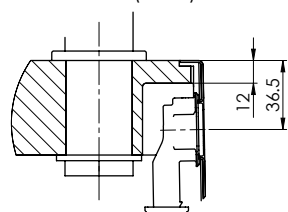

Y (1:2)

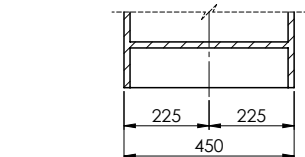
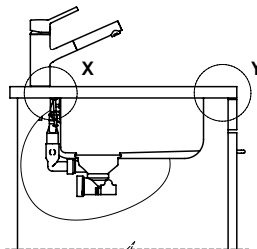
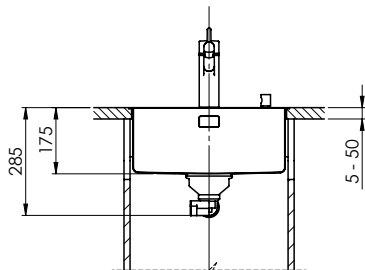
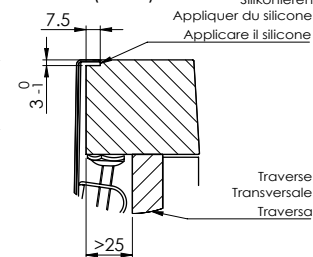

Bei der Planung die Traverse im Möbel beachten!

Faites attention à la barre transversale dans les meubles lors de la planification!

Presta attenzione alla traversa nei mobili durante la pianificazione!

Vom flächenbündigen Einbau in beschichteten Spanplatten raten wir ab.
 Nous vous déconseillons le montage à fleur sur des panneaux de particules enduits.
 Sconsigliamo il montaggio a filo top in pannelli di truciolato laminato.

Accento A 40IF/12 sFlow Typ S

Ausschnitt für flach aufliegender Einbau - Randbreite 12mm:
Mesure de coupeure pour montage en appui - Bord de 12mm de largeur:
Intaglio per montaggio soprapiano - Larghezza bordo 12mm:

Bohrung für Zug- und Druckknöpfe ø14
 Bohrung für Drehknopf ø25

Trou pour boutons et Pouvoirs de commande ø14
 Trou pour bouton rotatif ø25

Foro per Pomelli tiranti e Pomelli pulsanti ø14
 Foro per Pomolo girevoli ø25

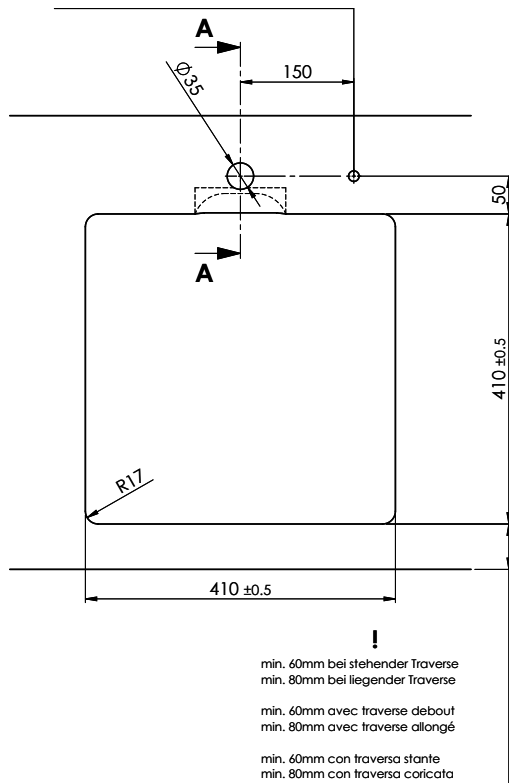

Für 12mm Arbeitsplatte.
 Pour plan de travail de 12 mm.
 Per piano di lavoro da 12 mm.

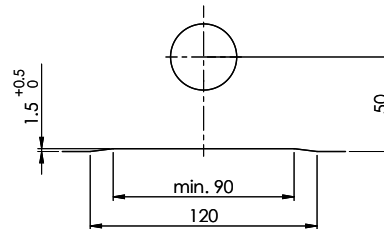

A-A (1 : 2)

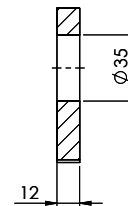

Für 13 - 30mm Arbeitsplatte.
 Pour plan de travail de 13 - 30mm.
 Per piano di lavoro da 13 - 30mm.

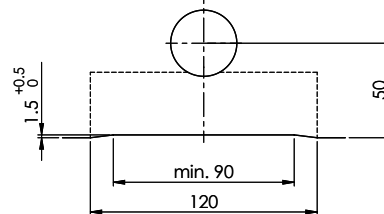

A-A (1 : 2)

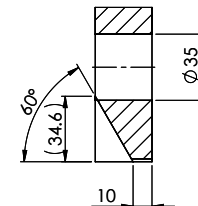

Für 13 - 50mm Arbeitsplatte.
 Pour plan de travail de 13 - 50mm.
 Per piano di lavoro da 13 - 50mm.

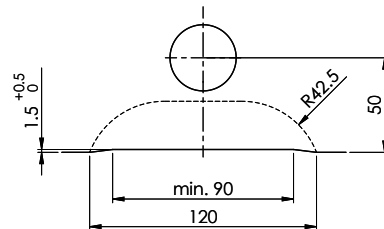

A-A (1 : 2)

