

## Comfort COM 34

[> Weblink](#)

**Montaggio**  
Lavelli da incasso

**Modello**  
COM 34

**Materiale**  
Acciaio inox 18/10

**N. di articolo**  
10.103.102.00

**Dimensioni base**  
40 cm

**Piletta**  
3½" Tipo

**Finitura**  
Lucido

**Prezzo in CHF**  
830.- IVA esclusa

**Dimensioni lavello**  
340x420x175mm

**Raggi d'angolo**  
50 mm

## Tecnologia di scarico e troppopieno



Griglietta - tipo S



Troppopieno coperto

## Premontaggio della piletta

Montaggio della piletta in fabbrica

## Distributore - opzioni di montaggio

Posizione a scelta

## Tecnologia di scarico e troppopieno

Pomolo inclusi

## Prezzi (aggiornati al 21.06.26 / IVA esclusa)

Modello	Materiale	Piletta	N. di articolo	Prezzo in CHF	
Comfort COM 34	Acciaio inox 18/10, Lucido	3½" Tipo	10.103.102.00	830.-	> Weblink
		3½" Salvaspazio	10.102.726.00	871.-	> Weblink

## Accessorio

Accessori opzionali



> Weblink  
40.001.004.00 / CHF 42.-  
Vaschetta, forato



> Weblink  
40.000.971.00 / CHF 106.-  
Vaschetta, forato



> Weblink  
40.000.915.00 / CHF 151.-  
Tagliere, in vetro, bianco

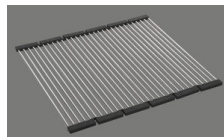

> Weblink  
40.001.138.00 / CHF 125.-  
Inox Pad

## Prodotti compatibili



> Weblink  
40.001.314.00 / CHF 155.-  
Distributore Nano



> Weblink  
40.001.023.00 / CHF 347.-  
Müllex Boxx 40-R

## Ricambi

Qui trovate tutti gli accessori compatibili &gt; Weblink

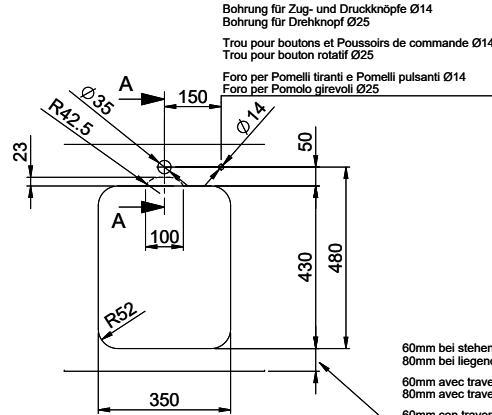
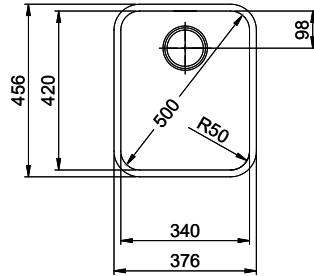

**A-A**  
**MAßSTAB 1 : 2**

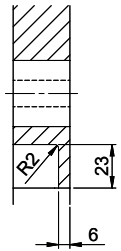

60mm bei stehender Traverse  
 80mm bei liegender Traverse  
 60mm avec traverse allongé  
 80mm avec traverse debout  
 60mm con traversa coricata  
 80mm con traversa stante

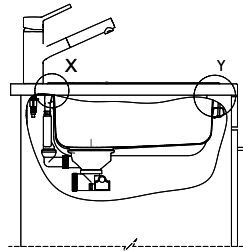
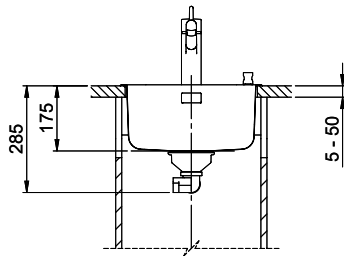

**DETAIL X**  
**MAßSTAB 1 : 2**

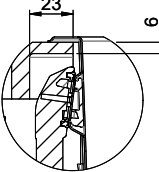

**DETAIL Y**  
**MAßSTAB 1 : 2**

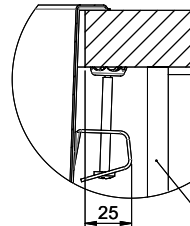

**Achtung: Traverse vorne beachten!**  
**Attention: respecter la traverse avant!**  
**Attenzione: rispettare la traversa avanti!**

