

Daneo DAN 18U

[> Weblink](#)

Montaggio
Lavelli sottopiano

Modello
DAN 18U

Materiale
Acciaio inox 18/10

N. di articolo
10.104.663.00

Dimensioni base
35 cm

Piletta
3½" eFlow Desino

Finitura
Opaco

TRA
0.19

Prezzo in CHF
1'248.- IVA esclusa

Dimensioni lavello
180x400x140mm

Raggi d'angolo
22 mm

Tecnologia di scarico e troppopieno



Desino: Scarico coperto con griglietta inferiore - tipo M



Troppopieno coperto eFlow

Premontaggio della piletta

Premontaggio della piletta in fabbrica

Tecnologia di scarico e troppopieno

Pomolo inclusi

Prezzi (aggiornati al 29.06.26 / IVA esclusa)

Modello	Materiale	Piletta	N. di articolo	Prezzo in CHF	
Daneo DAN 18U	Acciaio inox 18/10, Opaco	3½" Tipo Desino	10.105.593.00	923.-	> Weblink
		3½" TouchFlow Desino	10.104.631.00	1'133.-	> Weblink
		3½" eFlow Desino	10.104.663.00	1'248.-	> Weblink

Descrizione del prodotto

La griglietta per lo scarico Desino è lavabile in lavastoviglie e può essere pulita completamente o separatamente fino a una temperatura massima di 65 °C.

Accessorio

Accessori opzionali



> Weblink
40.000.912.00 / CHF 106.-
Vaschetta, forato



> Weblink
40.001.289.00 / CHF 106.-
Vaschetta, non forato

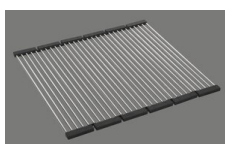

> Weblink
40.001.138.00 / CHF 125.-
Inox Pad

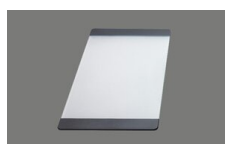

> Weblink
40.000.909.00 / CHF 151.-
Tagliere, in vetro, bianco

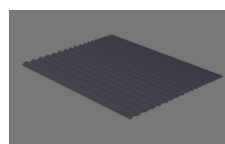

> Weblink
40.002.008.00 / CHF 51.-
Maro tappetino scolapiatti, Dark Grey



> Weblink
40.001.277.00 / CHF 151.-
Tagliere, sintetico

Ricambi

Qui trovate tutti gli accessori compatibili [> Weblink](#)

Daneo DAN 18U Desino

Masse / Ausschnittkontur
 Dimensions / contour de découpe
 Dimensioni / contorno dell'apertura

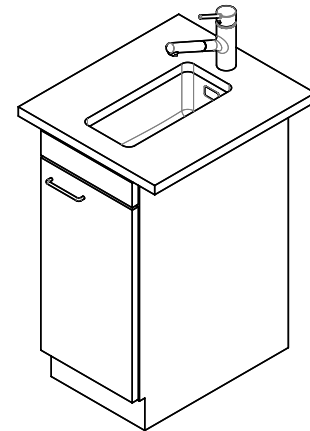
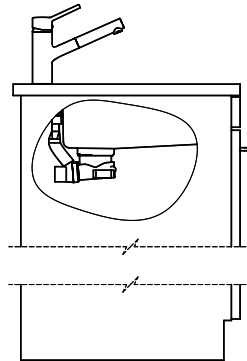
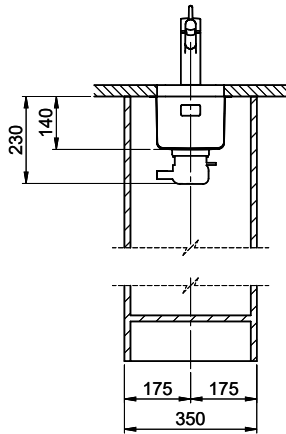
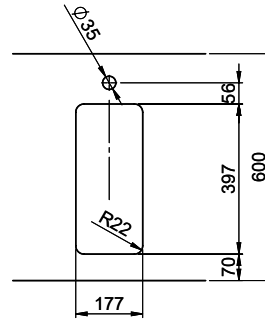
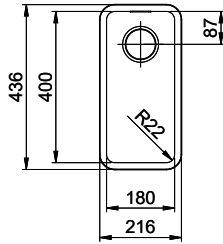

Für dieses Dokument und den darin dargestellten Gegenstand behalten wir uns alle Rechte vor. Verantwortliche Zeichnung ist die
 General Engineering AG. Dieses ist eine technische Zeichnung. © Copyright 2020 Suter Inox AG. Alle Rechte vorbehalten.