

## Daneo DAN 18U

[> Weblink](#)

**Montaggio**  
Lavelli sottopiano

**Modello**  
DAN 18U

**Materiale**  
Acciaio inox 18/10

**N. di articolo**  
10.105.593.00

**Dimensioni base**  
35 cm

**Piletta**  
3½" Tipo Desino

**Finitura**  
Opaco

**Prezzo in CHF**  
923.- IVA esclusa

**Dimensioni lavello**  
180x400x140mm

**Raggi d'angolo**  
22 mm

## Tecnologia di scarico e troppopieno



Tipo Desino: Scarico coperto con griglietta inferiore - tipo M



Placchetta di troppopieno a ribalta

## Premontaggio della piletta

Premontaggio della piletta in fabbrica

## Distributore - opzioni di montaggio

Posizione a scelta

## Tecnologia di scarico e troppopieno

## Prezzi (aggiornati al 29.06.26 / IVA esclusa)

Modello	Materiale	Piletta	N. di articolo	Prezzo in CHF	
Daneo DAN 18U	Acciaio inox 18/10, Opaco	3½" Tipo Desino	10.105.593.00	923.-	> Weblink
		3½" TouchFlow Desino	10.104.631.00	1'133.-	> Weblink
		3½" eFlow Desino	10.104.663.00	1'248.-	> Weblink

## Descrizione del prodotto

La griglietta per lo scarico Desino è lavabile in lavastoviglie e può essere pulita completamente o separatamente fino a una temperatura massima di 65 °C.

## Accessorio

## Accessori opzionali



> Weblink  
40.000.912.00 / CHF  
106.-  
Vaschetta, forato



> Weblink  
40.001.289.00 / CHF  
106.-  
Vaschetta, non forato

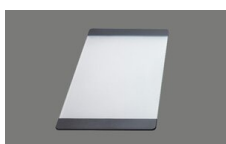

> Weblink  
40.000.909.00 / CHF  
151.-  
Tagliere, in vetro, bianco



> Weblink  
40.001.277.00 / CHF  
151.-  
Tagliere, sintetico

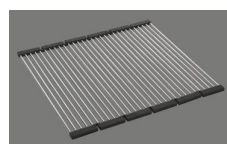

> Weblink  
40.001.138.00 / CHF  
125.-  
Inox Pad

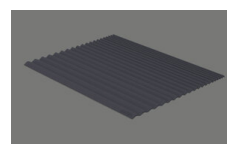

> Weblink  
40.002.008.00 / CHF 51.-  
Maro tappetino  
scolapiatti, Dark Grey

## Ricambi

Qui trovate tutti gli accessori compatibili [> Weblink](#)

# Daneo DAN 18U Desino

Masse / Ausschnittkontur  
 Dimensions / contour de découpe  
 Dimensioni / contorno dell'apertura

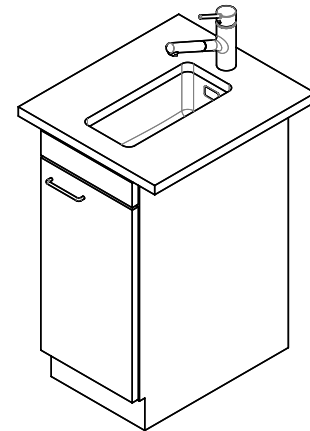
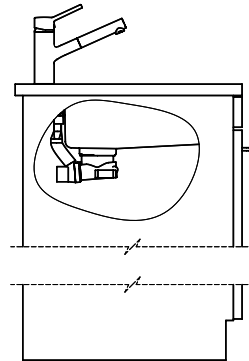
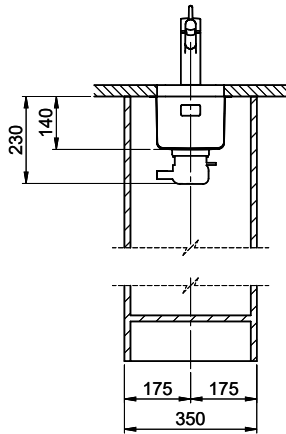
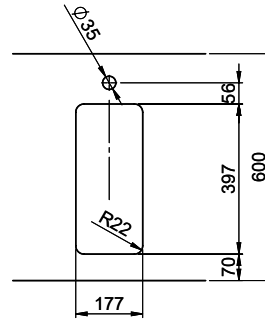
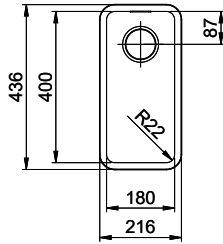

Für dieses Dokument und den darin dargestellten Gegenstand behalten wir uns alle Rechte vor. Verantwortliche Zeichnung ist die Entwurfs-Verfertigung sowie. Vorbehalten ist eine eventuelle Änderung der Konstruktion. © Copyright 2020 Suter Inox AG. Alle Rechte vorbehalten.