

## Daneo DAN 34F/7

&gt; Weblink



**Montaggio**  
Lavelli a filo top

**Modello**  
DAN 34F/7

**Materiale**  
Acciaio inox 18/10

**N. di articolo**  
10.104.643.00

**Dimensioni base**  
40 cm

**Piletta**  
3½" TouchFlow Desino

**Finitura**  
Opaco

**TRA**  
0.19

**Prezzo in CHF**  
1'542.- IVA esclusa

**Dimensioni lavello**  
340x400x175mm

**Raggi d'angolo**  
22 mm

## Tecnologia di scarico e troppopieno



Desino: Scarico coperto con griglietta inferiore - tipo M



Placchetta di troppopieno a ribalta TouchFlow

## Premontaggio della piletta

Premontaggio della piletta in fabbrica

## Distributore - opzioni di montaggio

Posizione a scelta

## Tecnologia di scarico e troppopieno

Pomolo inclusi

## Prezzi (aggiornati al 21.06.26 / IVA esclusa)

Modello	Materiale	Piletta	N. di articolo	Prezzo in CHF	
Daneo DAN 34F/7	Acciaio inox 18/10, Opaco	3½" eFlow Desino	10.104.670.00	1'657.-	> Weblink
		3½" TouchFlow Desino	10.104.643.00	1'542.-	> Weblink
		3½" Salvaspazio Desino	10.104.644.00	1'332.-	> Weblink
		3½" Tipo Desino	10.105.696.00	1'332.-	> Weblink

## Descrizione del prodotto

Disponibile solo per montaggio a filo top.

## Montaggio a filo top: Consiglio per la scelta del piano di lavoro

Consigliamo il montaggio nei piani di lavoro in ceramica, granito, pietra artificiale (per es. Corian o Varicor) oppure in legno massiccio. Sconsigliamo la posa in pannelli di truciolato rivestiti.

## Pulizia

La griglietta per lo scarico Desino è lavabile in lavastoviglie e può essere pulita completamente o separatamente fino a una temperatura massima di 65 °C.

## Accessorio

Accessori opzionali



> Weblink  
40.000.912.00 / CHF 106.-  
Vaschetta, forato



> Weblink  
40.001.289.00 / CHF 106.-  
Vaschetta, non forato



> Weblink  
40.000.909.00 / CHF 151.-  
Tagliere, in vetro, bianco



> Weblink  
40.001.277.00 / CHF 151.-  
Tagliere, sintetico

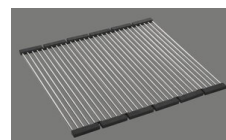

> Weblink  
40.001.138.00 / CHF 125.-  
Inox Pad

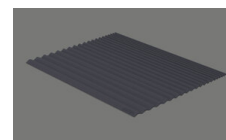

> Weblink  
40.002.008.00 / CHF 51.-  
Maro tappetino scolapiatti, Dark Grey

**Daneo DAN 34F7** [> Weblink](#)

**Ricambi**

Qui trovate tutti gli accessori compatibili [> Weblink](#)

# Daneo DAN 34F/7 Desino

**Randbreite 7mm**  
**Bord de 7mm de largeur**  
**Larghezza bordo 7mm**

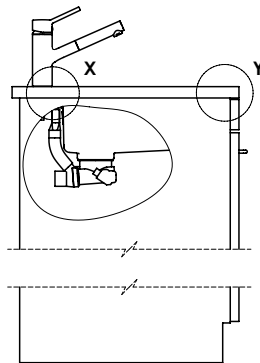
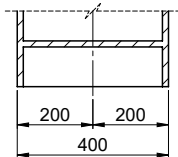
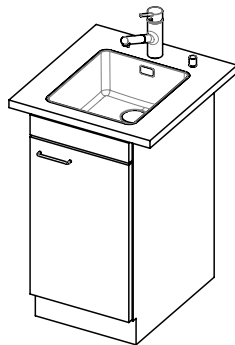

Bei der Planung die Traverse im Möbel beachten!

Faites attention à la barre transversale dans les meubles lors de la planification!

Presta attenzione alla traversa nei mobili durante la pianificazione!

Vom flächenbündigen Einbau in beschichteten Spanplatten raten wir ab.

Nous vous déconseillons le montage à fleur sur des panneaux de particules enduits.

Sconsigliamo il montaggio a filo top in pannelli di truciolato laminato.

Für 12mm Arbeitsplatte.  
 Pour plan de travail de 12mm.  
 Per piano di lavoro da 12mm.

X (1 : 2)

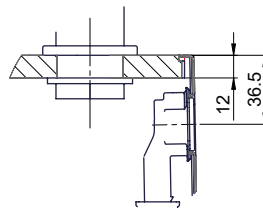

Y (1 : 2)

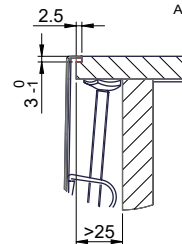

Silikonieren  
 Appliquer du silicone  
 Applicare il silicone

Traverse  
 Transversale  
 Traversa

Für 13 - 30mm Arbeitsplatte.  
 Pour plan de travail de 13 - 30mm.  
 Per piano di lavoro da 13 - 30mm.

X (1 : 2)

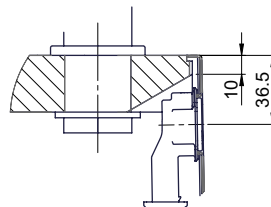

Y (1 : 2)

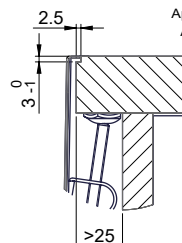

Silikonieren  
 Appliquer du silicone  
 Applicare il silicone

Traverse  
 Transversale  
 Traversa

Für 13 - 50mm Arbeitsplatte.  
 Pour plan de travail de 13 - 50mm.  
 Per piano di lavoro da 13 - 50mm.

X (1 : 2)

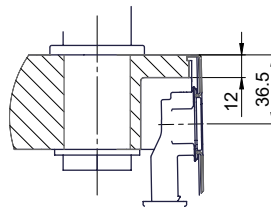

Y (1 : 2)

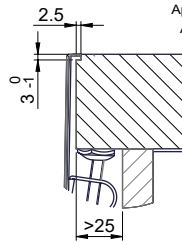

Silikonieren  
 Appliquer du silicone  
 Applicare il silicone

Traverse  
 Transversale  
 Traversa

# Daneo DAN 34F/7 Desino

Ausschnitt für flächenbündigen Einbau - Randbreite 7mm:  
 Mesure de coupe pour montage à fleur - Bord de 7mm de largeur:  
 Intaglio per montaggio a filo top - Larghezza bordo 7mm:

Bohrung für Zug- und Druckknöpfe ø14  
 Bohrung für Drehknopf ø25

Trou pour boutons et Pousoirs de commande ø14  
 Trou pour bouton rotatif ø25

Foro per Pomelli tiranti e Pomelli pulsanti ø14  
 Foro per Pomolo girevoli ø25

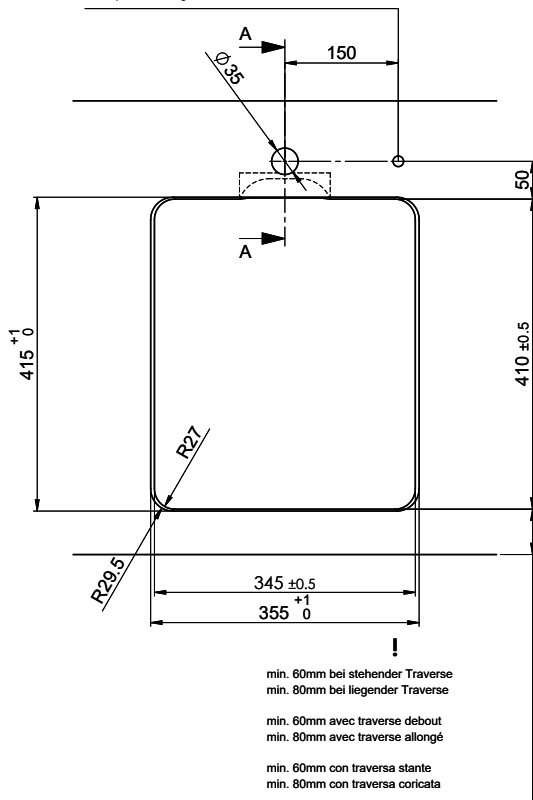

Für 12mm Arbeitsplatte.  
 Pour plan de travail de 12 mm.  
 Per piano di lavoro da 12 mm.

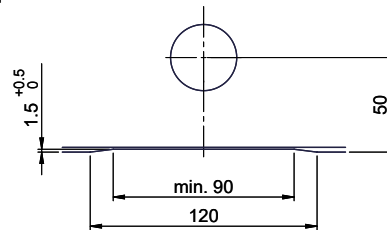

A-A (1 : 2)

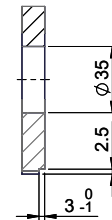

Für 13 - 30mm Arbeitsplatte.  
 Pour plan de travail de 13 - 30mm.  
 Per piano di lavoro da 13 - 30mm.

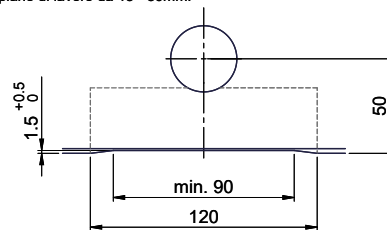

A-A (1 : 2)

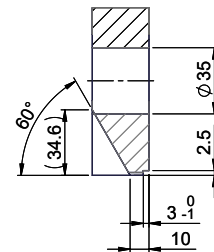

Für 13 - 50mm Arbeitsplatte.  
 Pour plan de travail de 13 - 50mm.  
 Per piano di lavoro da 13 - 50mm.

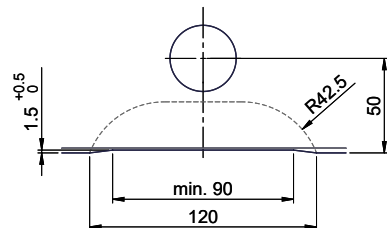

A-A (1 : 2)

