

Daneo DAN 40F/7

[> Weblink](#)**Montaggio**

Lavelli a filo top

Modello

DAN 40F/7

Materiale

Acciaio inox 18/10

N. di articolo

10.104.672.00

Dimensioni base

45 cm

Piletta

3½" eFlow Desino

Finitura

Opaco

TRA

0.19

Prezzo in CHF

1'724.- IVA esclusa

Dimensioni lavello

400x400x175mm

Raggi d'angolo

22 mm

Tecnologia di scarico e troppopieno

Desino: Scarico
coperto con griglietta
inferiore - tipo M



Troppopieno coperto
eFlow

Premontaggio della piletta

Premontaggio della piletta in fabbrica

Distributore - opzioni di montaggio

Posizione a scelta

Tecnologia di scarico e troppopieno**Pomolo inclusi****Prezzi (aggiornati al 06.05.26 / IVA esclusa)**

Modello	Materiale	Piletta	N. di articolo	Prezzo in CHF	
Daneo DAN 40F/7	Acciaio inox 18/10, Opaco	3½" Tipo Desino	10.105.704.00	1'399.-	> Weblink
		3½" Salvaspazio Desino	10.104.648.00	1'399.-	> Weblink
		3½" TouchFlow Desino	10.104.647.00	1'609.-	> Weblink
		3½" eFlow Desino	10.104.672.00	1'724.-	> Weblink

Descrizione del prodotto

Disponibile solo per montaggio a filo top.

Montaggio a filo top: Consiglio per la scelta del piano di lavoro

Consigliamo il montaggio nei piani di lavoro in ceramica, granito, pietra artificiale (per es. Corian o Varicor) oppure in legno massiccio. Sconsigliamo la posa in pannelli di truciolato rivestiti.

Pulizia

La griglietta per lo scarico Desino è lavabile in lavastoviglie e può essere pulita completamente o separatamente fino a una temperatura massima di 65 °C.

Accessorio

Accessori opzionali



> Weblink
40.000.912.00 / CHF
106.-
Vaschetta, forato



> Weblink
40.001.289.00 / CHF
106.-
Vaschetta, non forato



> Weblink
40.000.909.00 / CHF
151.-
Tagliere, in vetro, bianco



> Weblink
40.001.277.00 / CHF
151.-
Tagliere, sintetico

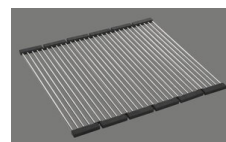

> Weblink
40.001.138.00 / CHF
125.-
Inox Pad

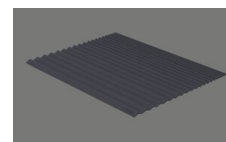

> Weblink
40.002.008.00 / CHF 51.-
Maro tappetino
scolapiatti, Dark Grey

Daneo DAN 40F7 [> Weblink](#)

Ricambi

Qui trovate tutti gli accessori compatibili [> Weblink](#)

