

Daneo DAN 40IF/12

> Weblink



Montaggio
Lavelli a filo top / Lavelli sopraiano

Modello
DAN 40IF/12

Materiale
Acciaio inox 18/10

N. di articolo
10.104.673.00

Dimensioni base
45 cm

Piletta
3½" eFlow Desino

Finitura
Opaco

TRA
0.19

Prezzo in CHF
1'407.- IVA esclusa

Dimensioni lavello
400x400x175mm

Raggi d'angolo
22 mm

Tecnologia di scarico e troppopieno



Desino: Scarico coperto con griglietta inferiore - tipo M



Troppopieno coperto eFlow

Premontaggio della piletta

Premontaggio della piletta in fabbrica

Distributore - opzioni di montaggio

Posizione a scelta

Tecnologia di scarico e troppopieno

Pomolo inclusi

Prezzi (aggiornati al 21.06.26 / IVA esclusa)

Modello	Materiale	Piletta	N. di articolo	Prezzo in CHF	
Daneo DAN 40IF/12	Acciaio inox 18/10, Opaco	3½" Tipo Desino	10.105.708.00	1'082.-	> Weblink
		3½" Salvaspazio Desino	10.104.650.00	1'082.-	> Weblink
		3½" TouchFlow Desino	10.104.649.00	1'292.-	> Weblink
		3½" eFlow Desino	10.104.673.00	1'407.-	> Weblink

Descrizione del prodotto

1 versione di prodotto, 2 metodi di montaggio

I modelli IF presentano un grande vantaggio: possono essere posati sia a filo top che sopraiano.

Montaggio a filo top: Consiglio per la scelta del piano di lavoro

Consigliamo il montaggio nei piani di lavoro in ceramica, granito, pietra artificiale (per es. Corian o Varicor) oppure in legno massiccio. Sconsigliamo la posa in pannelli di truciolato rivestiti.

Pulizia

La griglietta per lo scarico Desino è lavabile in lavastoviglie e può essere pulita completamente o separatamente fino a una temperatura massima di 65 °C.

Accessorio

Accessori opzionali



> Weblink
40.000.912.00 / CHF 106.-
Vaschetta, forato



> Weblink
40.001.289.00 / CHF 106.-
Vaschetta, non forato

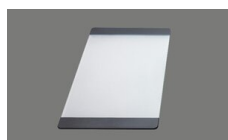

> Weblink
40.000.909.00 / CHF 151.-
Tagliere, in vetro, bianco



> Weblink
40.001.277.00 / CHF 151.-
Tagliere, sintetico

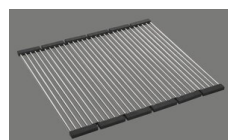

> Weblink
40.001.138.00 / CHF 125.-
Inox Pad

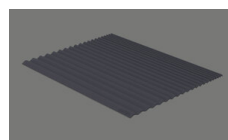

> Weblink
40.002.008.00 / CHF 51.-
Maro tappetino scolapiatti, Dark Grey

Daneo DAN 40IF/12 [> Weblink](#)

Ricambi

Qui trovate tutti gli accessori compatibili [> Weblink](#)

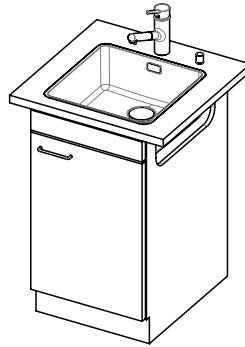
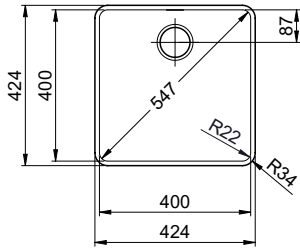

Für 12mm Arbeitsplatte.
 Pour plan de travail de 12mm.
 Per piano di lavoro da 12mm.

X (1 : 2)



Y (1 : 2)

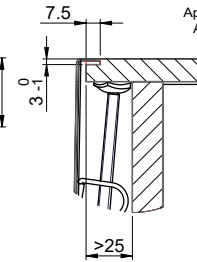

Silikonieren
 Appliquer du silicone
 Applicare il silicone

Traverse
 Transversale
 Traversa

Für 13 - 30mm Arbeitsplatte.
 Pour plan de travail de 13 - 30mm.
 Per piano di lavoro da 13 - 30mm.

X (1 : 2)

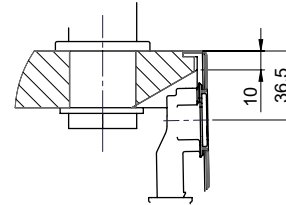

Y (1 : 2)

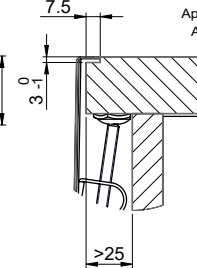

Silikonieren
 Appliquer du silicone
 Applicare il silicone

Traverse
 Transversale
 Traversa

Für 13 - 50mm Arbeitsplatte.
 Pour plan de travail de 13 - 50mm.
 Per piano di lavoro da 13 - 50mm.

X (1 : 2)

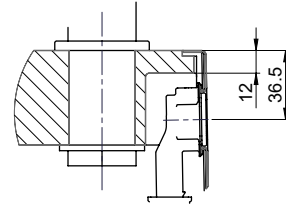

Y (1 : 2)

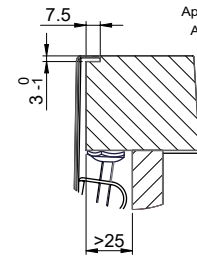

Silikonieren
 Appliquer du silicone
 Applicare il silicone

Traverse
 Transversale
 Traversa

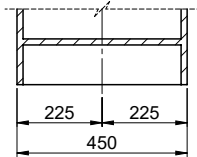
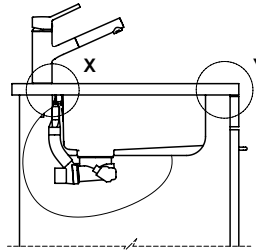
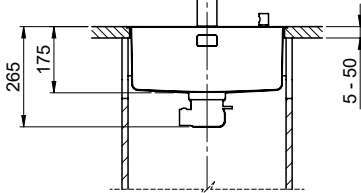

Bei der Planung die Traverse im Möbel beachten!

Faites attention à la barre transversale dans les meubles lors de la planification!

Presta attenzione alla traversa nei mobili durante la pianificazione!

Vom flächenbündigen Einbau in beschichteten Spanplatten raten wir ab.

Nous vous déconseillons le montage à fleur sur des panneaux de particules enduits.

Sconsigliamo il montaggio a filo top in pannelli di truciolato laminato.

Daneo DAN 40IF/12 Desino

Ausschnitt für flächenbündigen Einbau - Randbreite 12mm:
Mesure de coupe pour montage à fleur - Bord de 12mm de largeur:
Intaglio per montaggio a filo top - Larghezza bordo 12mm:

Bohrung für Zug- und Druckknöpfe ø14
 Bohrung für Drehknopf ø25

Trou pour boutons et Pousoirs de commande ø14
 Trou pour bouton rotatif ø25

Foro per Pomelli tiranti e Pomelli pulsanti ø14
 Foro per Pomolo girevoli ø25

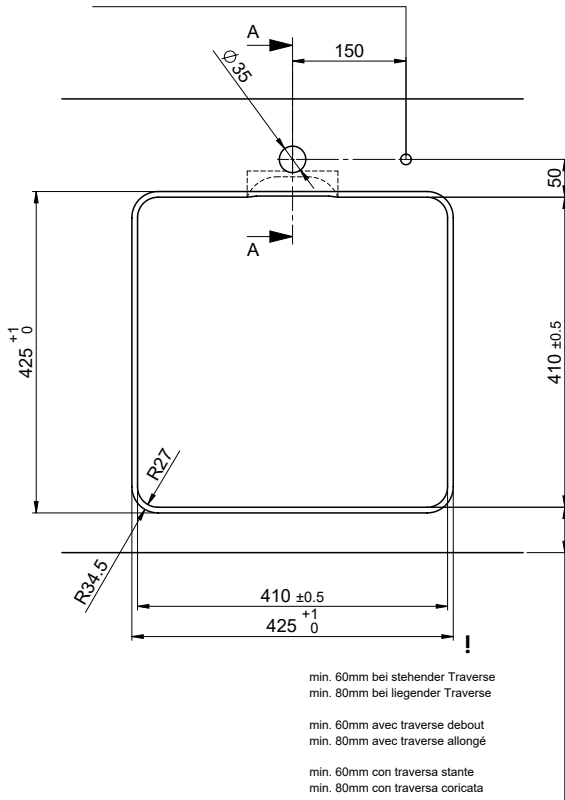

Für 12mm Arbeitsplatte.
 Pour plan de travail de 12 mm.
 Per piano di lavoro da 12 mm.

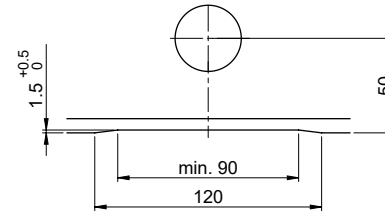

A-A (1 : 2)

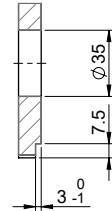

Für 13 - 30mm Arbeitsplatte.
 Pour plan de travail de 13 - 30mm.
 Per piano di lavoro da 13 - 30mm.

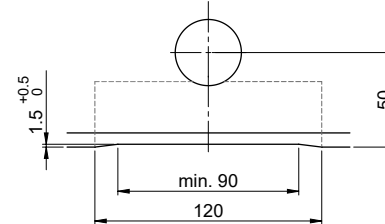

A-A (1 : 2)

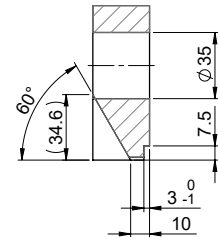

Für 13 - 50mm Arbeitsplatte.
 Pour plan de travail de 13 - 50mm.
 Per piano di lavoro da 13 - 50mm.

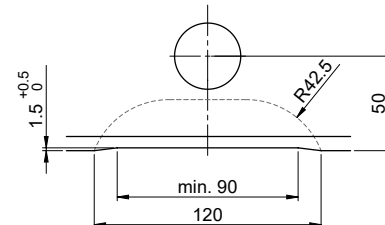

A-A (1 : 2)

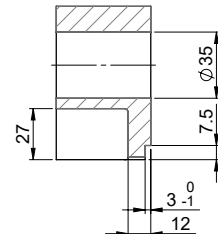

Daneo DAN 40IF/12 Desino

Suter Inox AG
 Schärerstrasse 25
 CH-1116 Schönenbuch
 T +41 78 822 64 00
 info@suter.ch
 suter.ch

Ausschnitt für flach aufliegender Einbau - Randbreite 12mm:
 Mesure de coupure pour montage en appui - Bord de 12mm de largeur:
 Intaglio per montaggio sopra piano - Larghezza bordo 12mm:

SUTER

Bohrung für Zug- und Druckknöpfe ø14
 Bohrung für Drehknopf ø25

Trou pour boutons et Pousoirs de commande ø14
 Trou pour bouton rotatif ø25

Foro per Pomelli tiranti e Pomelli pulsanti ø14
 Foro per Pomolo girevoli ø25



Für 12mm Arbeitsplatte.
 Pour plan de travail de 12 mm.
 Per piano di lavoro da 12 mm.

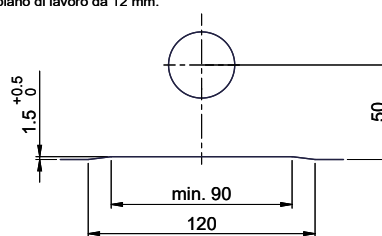

A-A (1 : 2)



Für 13 - 30mm Arbeitsplatte.
 Pour plan de travail de 13 - 30mm.
 Per piano di lavoro da 13 - 30mm.



A-A (1 : 2)



Für 13 - 50mm Arbeitsplatte.
 Pour plan de travail de 13 - 50mm.
 Per piano di lavoro da 13 - 50mm.

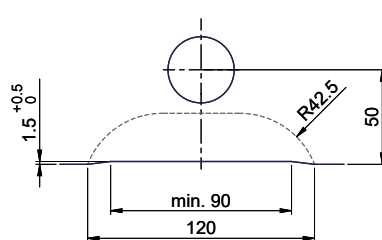

A-A (1 : 2)

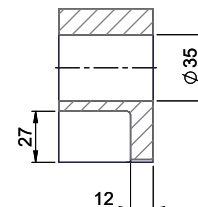

Für diese Dokument sind den abgesetzten Gegenstand behalten wir uns alle Rechte vor. Verewaltigung, Behauptung an
 Dritte, Verbreitung sowie Verleihung ohne unsere schriftliche Zustimmung ist verboten. © Copyright 2020 Suter Inox AG. Alle Rechte vorbehalten.