

Daneo DAN CP 50F/17

> Weblink



Dimensioni base 55 cm

Montaggio
Lavelli a filo top
Modello
DAN CP 50F/17
Materiale
Cristalite Plus
N. di articolo
10.104.710.00

Dimensioni base
55 cm
Piletta
3½" TouchFlow
Colore
Everest
TRA
0.19
Prezzo in CHF
1'349.- IVA esclusa

Dimensioni lavello
500x400x165mm
Raggi d'angolo
22 mm

Tecnologia di scarico e troppopieno



Griglietta - tipo S, per lavelli in granito

Placchetta di troppopieno a ribalta TouchFlow per lavelli in granito

Premontaggio della piletta

Montaggio della piletta in fabbrica

Distributore - opzioni di montaggio

Posizione a scelta

Tecnologia di scarico e troppopieno

Pomolo inclusi

Prezzi (aggiornati al 25.06.26 / IVA esclusa)

Modello	Materiale	Piletta	N. di articolo	Prezzo in CHF	
Daneo DAN CP 50F/17 - Everest	Cristalite Plus, Everest	3½" Tipo	10.104.712.00	1'110.-	> Weblink
		3½" Salvaspazio	10.104.711.00	1'151.-	> Weblink
		3½" TouchFlow	10.104.710.00	1'349.-	> Weblink

Descrizione del prodotto

Materiale

Lavelli in granito Cristalite Plus: I lavelli si compongono all'80% di quarzo, la parte più dura del granito. Il granito viene legato con acrilico di altissima qualità. La composizione di acrilico e granito rende i lavelli resistenti ai graffi e alla sporcizia garantendo una lunga durata.

Disponibile solo per montaggio a filo top.

Montaggio a filo top: Consiglio per la scelta del piano di lavoro

Consigliamo il montaggio nei piani di lavoro in ceramica, granito, pietra artificiale (per es. Corian o Varicor) oppure in legno massiccio. Sconsigliamo la posa in pannelli di truciolato rivestiti.

Accessorio

Qui trovate tutti gli accessori > Weblink

Accessori opzionali



> Weblink
40.000.912.00 / CHF 106.-
Vaschetta, forato



> Weblink
40.001.289.00 / CHF 106.-
Vaschetta, non forato

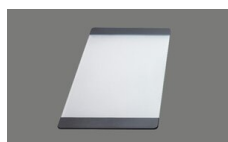

> Weblink
40.000.909.00 / CHF 151.-
Tagliere, in vetro, bianco



> Weblink
40.001.277.00 / CHF 151.-
Tagliere, sintetico

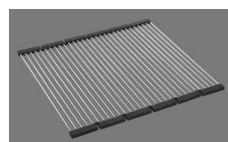

> Weblink
40.001.138.00 / CHF 125.-
Innox Pad



> Weblink
40.001.509.00 / CHF 29.-
Kit di pulizia Easy Care per lavelli in granito

Daneo DAN CP 50F/17 [> Weblink](#)

Ricambi

Qui trovate tutti gli accessori compatibili [> Weblink](#)

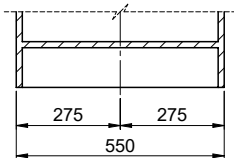
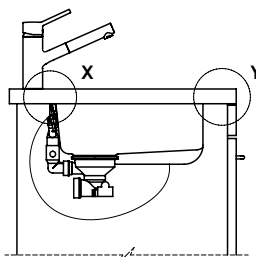

Vom flächenbündigen Einbau in beschichteten Spanplatten raten wir ab.
 Nous vous déconseillons le montage à fleur sur des panneaux de particules enduits.
 Sconsigliamo il montaggio a filo top in pannelli di truciolato laminato.

Bei der Planung die Traverse im Möbel beachten!
 Faites attention à la barre transversale dans les meubles lors de la planification!
 Presta attenzione alla traversa nei mobili durante la pianificazione!

Für 12mm Arbeitsplatte.
 Pour plan de travail de 12mm.
 Per piano di lavoro da 12mm.



Für 13 - 30mm Arbeitsplatte.
 Pour plan de travail de 13 - 30mm.
 Per piano di lavoro da 13 - 30mm.

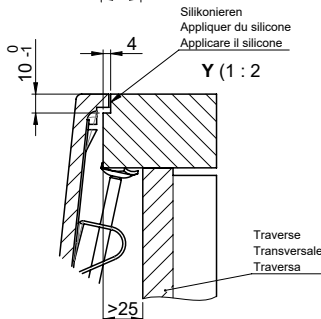

Für 13 - 50mm Arbeitsplatte.
 Pour plan de travail de 13 - 50mm.
 Per piano di lavoro da 13 - 50mm.

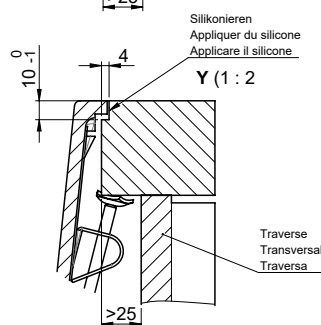

Bohrung für Zug- und Druckknöpfe ø14
 Bohrung für Drehknopf ø25

Trou pour boutons et Poussoirs de commande ø14
 Trou pour bouton rotatif ø25

Foro per Pomelli tiranti e Pomelli pulsanti ø14
 Foro per Pomolo girevoli ø25

Für 12mm Arbeitsplatte.
 Pour plan de travail de 12 mm.
 Per piano di lavoro da 12 mm.

A-A (1 : 2)

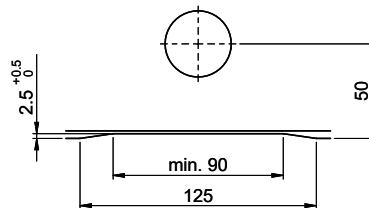

Für 13 - 30mm Arbeitsplatte.
 Pour plan de travail de 13 - 30mm.
 Per piano di lavoro da 13 - 30mm.

A-A (1 : 2)

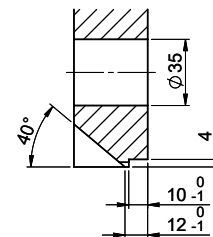
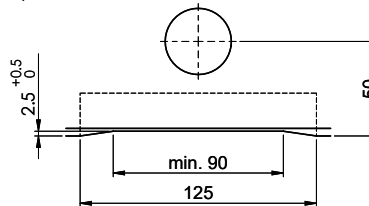

Für 13 - 50mm Arbeitsplatte.
 Pour plan de travail de 13 - 50mm.
 Per piano di lavoro da 13 - 50mm.

A-A (1 : 2)

