

Daneo DAN CP 50U/2

> Weblink

Dimensioni base 55 cm

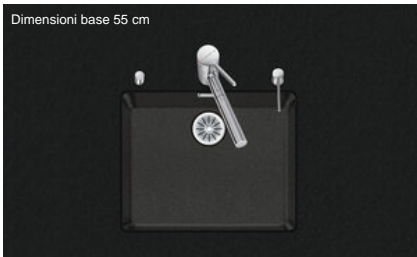

Montaggio
Lavelli sottopiano
Modello
DAN CP 50U/2
Materiale
Cristalite Plus
N. di articolo
10.104.771.00

Dimensioni base
55 cm
Piletta
3 1/2" Salvaspazio
Colore
Nero
Prezzo in CHF
1'151.- IVA esclusa

Dimensioni lavello
500x400x165mm
Raggi d'angolo
22 mm

Tecnologia di scarico e troppopieno



Griglietta - tipo S, per lavelli in granito



Placchetta di troppopieno a ribalta per lavelli in granito

Premontaggio della piletta

Montaggio della piletta in fabbrica

Distributore - opzioni di montaggio

Posizione a scelta

Tecnologia di scarico e troppopieno

Pomolo inclusi



Advant

Prezzi (aggiornati al 21.06.26 / IVA esclusa)

Modello	Materiale	Piletta	N. di articolo	Prezzo in CHF	
Daneo DAN CP 50U/2 - Nero	Cristalite Plus, Nero	3 1/2" Tipo	10.104.772.00	1'110.-	> Weblink
		3 1/2" Salvaspazio	10.104.771.00	1'151.-	> Weblink
		3 1/2" TouchFlow	10.104.770.00	1'349.-	> Weblink

Descrizione del prodotto

Materiale

Lavelli in granito Cristalite Plus: I lavelli si compongono all'80% di quarzo, la parte più dura del granito. Il granito viene legato con acrilico di altissima qualità. La composizione di acrilico e granito rende i lavelli resistenti ai graffi e alla sporcizia garantendo una lunga durata.

Accessorio

Qui trovate tutti gli accessori > Weblink

Accessori opzionali



> Weblink
40.002.560.00 / CHF
319.-
3 1/2" Salvaspazio, tipo S
| Nero opaco



> Weblink
40.000.912.00 / CHF
106.-
Vaschetta, forato



> Weblink
40.001.289.00 / CHF
106.-
Vaschetta, non forato

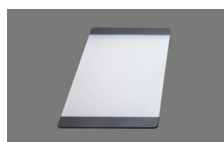

> Weblink
40.000.909.00 / CHF
151.-
Tagliere, in vetro, bianco



> Weblink
40.001.277.00 / CHF
151.-
Tagliere, sintetico

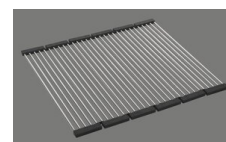

> Weblink
40.001.138.00 / CHF
125.-
Inox Pad

Ricambi

Qui trovate tutti gli accessori compatibili > Weblink

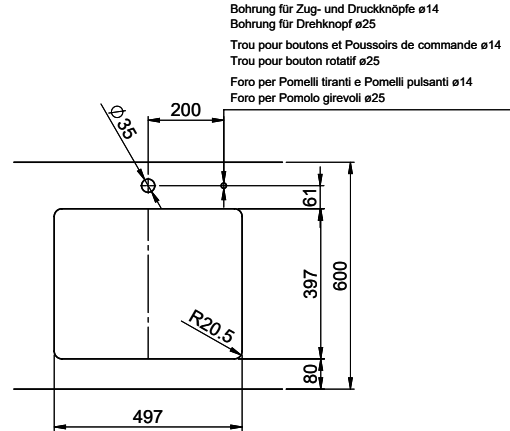
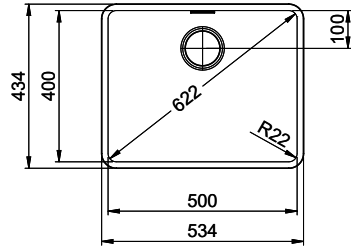

Bohrung für Zug- und Druckknöpfe ø14
 Bohrung für Drehknopf ø25
 Trou pour boutons et Pousoirs de commande ø14
 Trou pour bouton rotatif ø25
 Foro per Pomelli tiranti e Pomelli pulsanti ø14
 Foro per Pomolo girevoli ø25

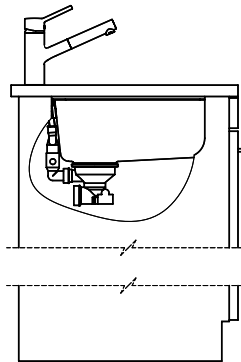
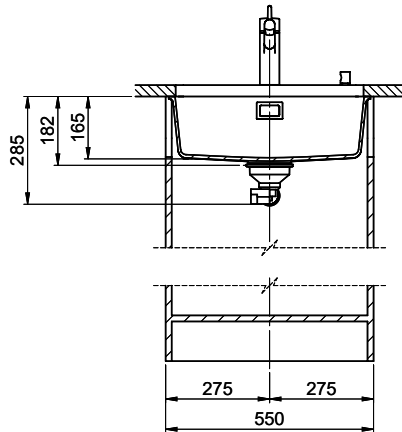

Für dieses Dokument und den darin dargestellten Gegenstand bestehen wir uns als Rechte vor: Verwirklichung, Beherrschung an
 Gattung, Verwertung sowie Vorzug einer materiellen Zustimmung der Parteien. © Copyright 2020 Suter Inox AG. All rights reserved.