

Linero LIO 45F/7

> Weblink

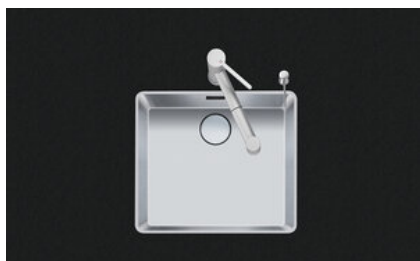

Montaggio
Lavelli a filo top
Modello
LIO 45F/7
Materiale
Acciaio inox 18/10
N. di articolo
10.105.241.00

Dimensioni base
50 cm
Piletta
3½" eFlow Desino
Finitura
Opaco
TRA
0.19
Prezzo in CHF
1'930.- IVA esclusa

Dimensioni lavello
450x400x175mm
Raggi d'angolo
15 mm

Tecnologia di scarico e troppopieno



Desino: Scarico coperto con griglietta inferiore - tipo M



Troppopieno coperto eFlow

Premontaggio della piletta

Premontaggio della piletta in fabbrica

Distributore - opzioni di montaggio

Posizione a scelta

Tecnologia di scarico e troppopieno

Pomolo inclusi

Prezzi (aggiornati al 21.06.26 / IVA esclusa)

Modello	Materiale	Piletta	N. di articolo	Prezzo in CHF	
Linero LIO 45F/7	Acciaio inox 18/10, Opaco	3½" TouchFlow	10.105.663.00	1'605.-	> Weblink
		3½" Salvaspazio Desino	10.105.243.00	1'605.-	> Weblink
		3½" TouchFlow Desino	10.105.242.00	1'815.-	> Weblink
		3½" eFlow Desino	10.105.241.00	1'930.-	> Weblink

Descrizione del prodotto

La griglietta per lo scarico Desino è lavabile in lavastoviglie e può essere pulita completamente o separatamente fino a una temperatura massima di 65 °C.

Accessorio

Accessori opzionali



> Weblink
40.000.912.00 / CHF 106.-
Vaschetta, forato



> Weblink
40.001.289.00 / CHF 106.-
Vaschetta, non forato

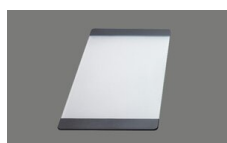

> Weblink
40.000.909.00 / CHF 151.-
Tagliere, in vetro, bianco



> Weblink
40.001.277.00 / CHF 151.-
Tagliere, sintetico

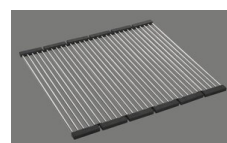

> Weblink
40.001.138.00 / CHF 125.-
Inox Pad

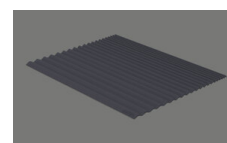

> Weblink
40.002.008.00 / CHF 51.-
Maro tappetino scolapiatti, Dark Grey

Ricambi

Qui trovate tutti gli accessori compatibili > Weblink

Linero LIO 45F/7 Desino

Randbreite 7mm
 Bord de 7mm de largeur
 Larghezza bordo 7mm

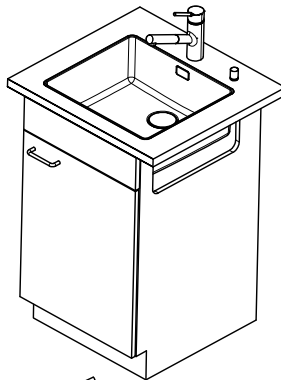
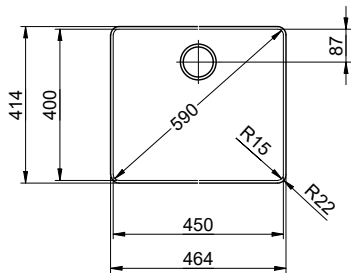

Für 12mm Arbeitsplatte.
 Pour plan de travail de 12mm.
 Per piano di lavoro da 12mm.

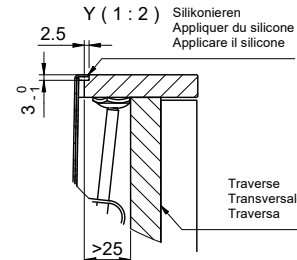
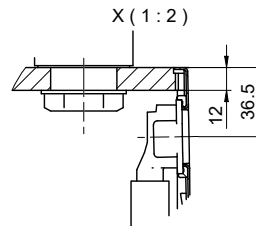

Für 13 - 30mm Arbeitsplatte.
 Pour plan de travail de 13 - 30mm.
 Per piano di lavoro da 13 - 30mm.

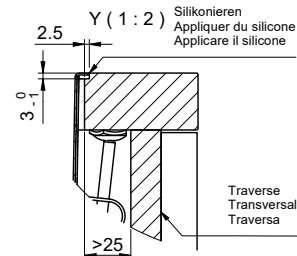
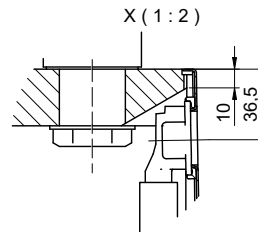

Für 13 - 50mm Arbeitsplatte.
 Pour plan de travail de 13 - 50mm.
 Per piano di lavoro da 13 - 50mm.

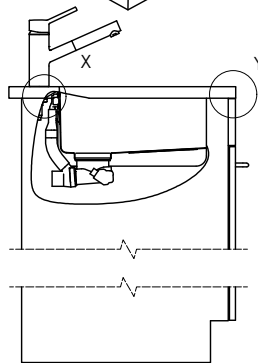
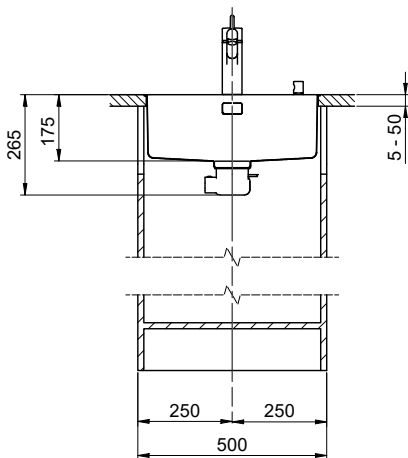
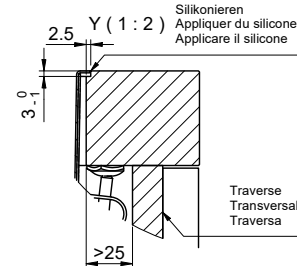
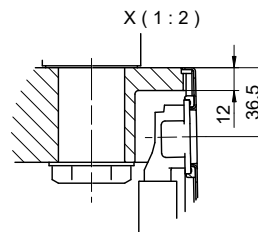

Bei der Planung die Traverse im Möbel beachten!

Faites attention à la barre transversale dans les meubles lors de la planification!

Presta attenzione alla traversa nei mobili durante la pianificazione!

Vom flächenbündigen Einbau in beschichtete Spanplatten raten wir ab.

Nous vous déconseillons le montage à fleur sur des panneaux de particules enduits.

Sconsigliamo il montaggio a filo top in pannelli di truciolato laminato.

Für dieses Dokument sind die darin abgezeichneten Gegenstände behalten wir uns alle Rechte vor. Verwendföhrig. Bekenntnisse an Dritte sind. Verwendung dieses Zeichens ohne unsere Zustimmung ist verboten. © Copyright 2007 Suter Inox AG. All rights reserved.

Linero LIO 45F/7 Desino

Ausschnitt für flächenbündigen Einbau - Randbreite 7mm:
Mesure de coupure pour montage à fleur - Bord de 7mm de largeur:
Intaglio per montaggio a filo top - Larghezza bordo 7mm:

Bohrung für Zug- und Druckknöpfe Ø14
 Bohrung für Drehknopf Ø25

Trou pour boutons et Pousoirs de commande Ø14
 Trou pour bouton rotatif Ø25

Foro per Pomelli tiranti e Pomelli pulsanti Ø14
 Foro per Pomolo girevoli Ø25



Für 12mm Arbeitsplatte.
 Pour plan de travail de 12mm.
 Per piano di lavoro da 12mm.



Für 13 - 30mm Arbeitsplatte.
 Pour plan de travail de 13 - 30mm.
 Per piano di lavoro da 13 - 30mm.

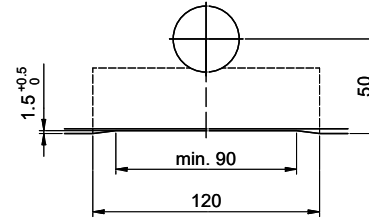

Für 13 - 50mm Arbeitsplatte.
 Pour plan de travail de 13 - 50mm.
 Per piano di lavoro da 13 - 50mm.

