

**Linero LIO 45F/7**
[> Weblink](#)

**Montaggio**  
Lavelli a filo top

**Modello**  
LIO 45F/7

**Materiale**  
Acciaio inox 18/10

**N. di articolo**  
10.105.665.00

**Dimensioni base**  
50 cm

**Piletta**  
3½" Salvaspazio

**Finitura**  
Opaco

**Prezzo in CHF**  
1'465.- IVA esclusa

**Dimensioni lavello**  
450x400x175mm

**Raggi d'angolo**  
15 mm

**Tecnologia di scarico e troppopieno**

Griglietta - tipo M



Placchetta di troppopieno a ribalta

**Premontaggio della piletta**

Premontaggio della piletta in fabbrica

**Distributore - opzioni di montaggio**

Posizione a scelta

**Tecnologia di scarico e troppopieno**
**Pomolo inclusi**

Advant

**Prezzi (aggiornati al 21.06.26 / IVA esclusa)**

Modello	Materiale	Piletta	N. di articolo	Prezzo in CHF	
Linero LIO 45F/7	Acciaio inox 18/10, Opaco	3½" Tipo	10.105.666.00	1'424.-	> Weblink
		3½" Salvaspazio	10.105.665.00	1'465.-	> Weblink
		3½" Salvaspazio	10.106.243.00	1'510.-	> Weblink
		3½" TouchFlow	10.105.664.00	1'663.-	> Weblink

**Accessorio**
**Accessori opzionali**

> Weblink  
40.000.912.00 / CHF  
106.-  
Vaschetta, forato



> Weblink  
40.001.289.00 / CHF  
106.-  
Vaschetta, non forato



> Weblink  
40.000.909.00 / CHF  
151.-  
Tagliere, in vetro, bianco



> Weblink  
40.001.277.00 / CHF  
151.-  
Tagliere, sintetico

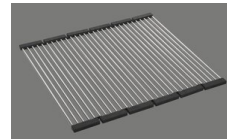

> Weblink  
40.001.138.00 / CHF  
125.-  
Innox Pad

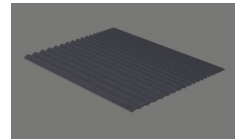

> Weblink  
40.002.008.00 / CHF 51.-  
Maro tappetino  
scolapiatti, Dark Grey

**Ricambi**

Qui trovate tutti gli accessori compatibili &gt; Weblink

# Linero LIO 45F/7 Desino

**Randbreite 7mm**  
**Bord de 7mm de largeur**  
**Larghezza bordo 7mm**

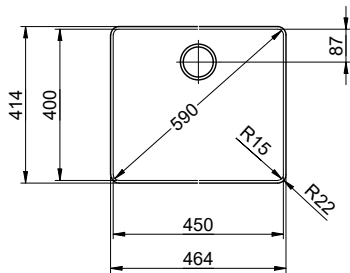

Für 12mm Arbeitsplatte.  
 Pour plan de travail de 12mm.  
 Per piano di lavoro da 12mm.

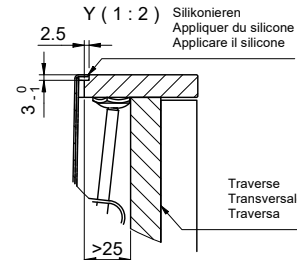
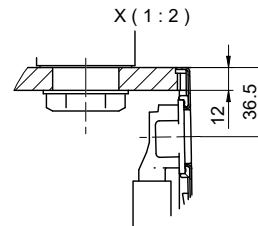

Für 13 - 30mm Arbeitsplatte.  
 Pour plan de travail de 13 - 30mm.  
 Per piano di lavoro da 13 - 30mm.

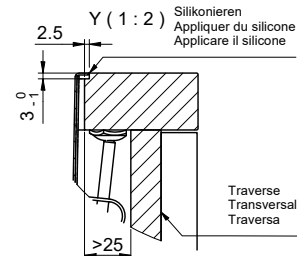
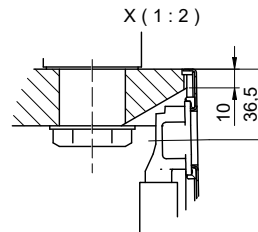

Für 13 - 50mm Arbeitsplatte.  
 Pour plan de travail de 13 - 50mm.  
 Per piano di lavoro da 13 - 50mm.

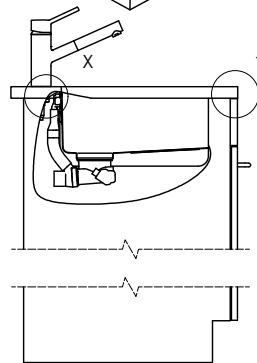
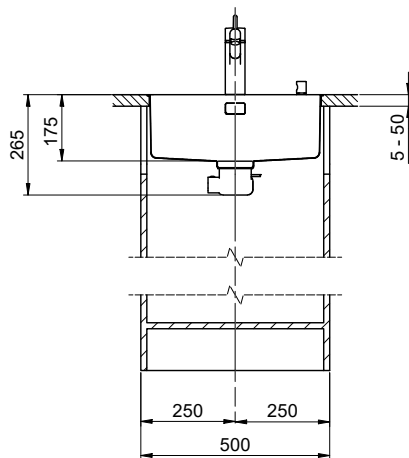
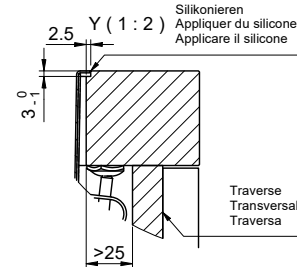
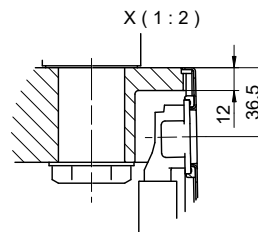

Bei der Planung die Traverse im Möbel beachten!

Faites attention à la barre transversale dans les meubles lors de la planification!

Presta attenzione alla traversa nei mobili durante la pianificazione!

Vom flächenbündigen Einbau in beschichtete Spanplatten raten wir ab.

Nous vous déconseillons le montage à fleur sur des panneaux de particules enduits.

Sconsigliamo il montaggio a filo top in pannelli di truciolato laminato.

Für dieses Dokument und die darin abgezeichneten Gegenstände behalten wir uns alle Rechte vor. Verwendföhrig. Bekenntnisse an Dritte ohne Verantwortung. Dieses Produkt ist ein Produkt der Suterwerkstrasse 40, CH-1214 St. Sulpice (VD) Schweiz. © Copyright 2020 Suterwerkstrasse 40, CH-1214 St. Sulpice (VD) Schweiz.

# Linero LIO 45F/7 Desino

**Ausschnitt für flächenbündigen Einbau - Randbreite 7mm:**  
**Mesure de coupure pour montage à fleur - Bord de 7mm de largeur:**  
**Intaglio per montaggio a filo top - Larghezza bordo 7mm:**

Bohrung für Zug- und Druckknöpfe Ø14  
 Bohrung für Drehknopf Ø25

Trou pour boutons et Pousoirs de commande Ø14  
 Trou pour bouton rotatif Ø25

Foro per Pomelli tiranti e Pomelli pulsanti Ø14  
 Foro per Pomolo girevoli Ø25



Für 12mm Arbeitsplatte.  
 Pour plan de travail de 12mm.  
 Per piano di lavoro da 12mm.



A-A (1 : 2)

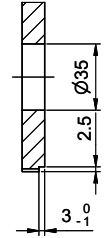

Für 13 - 30mm Arbeitsplatte.  
 Pour plan de travail de 13 - 30mm.  
 Per piano di lavoro da 13 - 30mm.

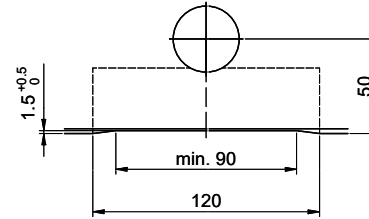

A-A (1 : 2)

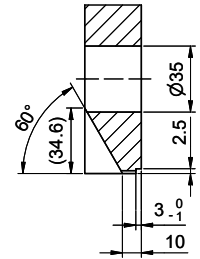

Für 13 - 50mm Arbeitsplatte.  
 Pour plan de travail de 13 - 50mm.  
 Per piano di lavoro da 13 - 50mm.

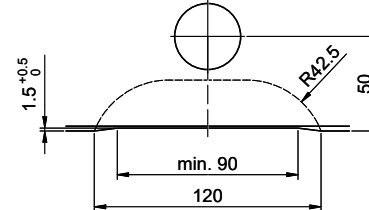

A-A (1 : 2)

