

Linero LIO CD 50F/17

> Weblink

Dimensioni base 55 cm



Montaggio
Lavelli a filo top
Modello
LIO CD 50F/17
Materiale
Cristadur
N. di articolo
10.105.690.00

Dimensioni base
55 cm
Piletta
3½" Salvaspazio
Colore
Polaris
Prezzo in CHF
1'297.- IVA esclusa

Dimensioni lavello
500x400x165mm
Raggi d'angolo
15 mm

Tecnologia di scarico e troppopieno



Griglietta - tipo M, per lavelli in granito



Placchetta di troppopieno a ribalta per lavelli in granito

Premontaggio della piletta

Premontaggio della piletta in fabbrica

Distributore - opzioni di montaggio

Posizione a scelta

Tecnologia di scarico e troppopieno

Pomolo inclusi



Advant

Prezzi (aggiornati al 21.06.26 / IVA esclusa)

Modello	Materiale	Piletta	N. di articolo	Prezzo in CHF	
Linero LIO CD 50F/17 Polaris	Cristadur, Polaris	3½" Tipo	10.105.691.00	1'256.-	> Weblink
		3½" Salvaspazio	10.105.690.00	1'297.-	> Weblink
		3½" Salvaspazio	10.106.254.00	1'342.-	> Weblink
		3½" TouchFlow	10.105.689.00	1'495.-	> Weblink

Accessorio

Accessori opzionali



> Weblink
40.000.912.00 / CHF 106.-
Vaschetta, forato



> Weblink
40.001.289.00 / CHF 106.-
Vaschetta, non forato

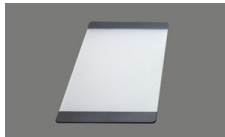

> Weblink
40.000.909.00 / CHF 151.-
Tagliere, in vetro, bianco



> Weblink
40.001.277.00 / CHF 151.-
Tagliere, sintetico

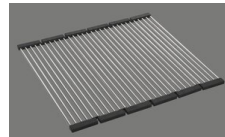

> Weblink
40.001.138.00 / CHF 125.-
Inox Pad



> Weblink
40.001.509.00 / CHF 29.-
Kit di pulizia Easy Care per lavelli in granito

Ricambi

Qui trovate tutti gli accessori compatibili > Weblink

Linero LIO CD 50F/ 17 Desino

Randbreite 17mm
Bord de 17mm de largeur
Larghezza bordo 17mm



Für 12mm Arbeitsplatte.
 Pour plan de travail de 12mm.
 Per piano di lavoro da 12mm.



Für 13 - 30mm Arbeitsplatte.
 Pour plan de travail de 13 - 30mm.
 Per piano di lavoro da 13 - 30mm.

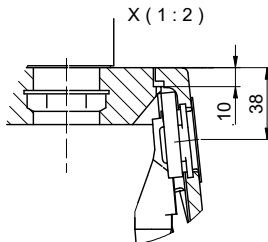

Für 13 - 50mm Arbeitsplatte.
 Pour plan de travail de 13 - 50mm.
 Per piano di lavoro da 13 - 50mm.

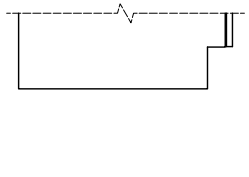
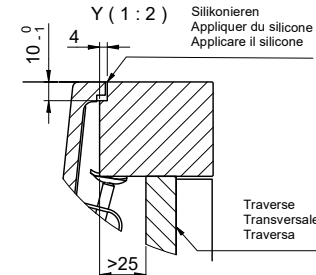
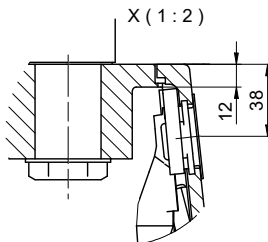

Bei der Planung die Traverse im Möbel beachten!

Faites attention à la barre transversale dans les meubles lors de la planification!

Presta attenzione alla traversa nei mobili durante la pianificazione!

Vom flächenbündigen Einbau in beschichtete Spanplatten raten wir ab.

Nous vous déconseillons le montage à fleur sur des panneaux de particules enduits.

Sconsigliamo il montaggio a filo top in pannelli di truciolato laminato.

Linero LIO CD 50F/ 17 Desino

Ausschnitt für flächenbündigen Einbau - Randbreite 17mm:
Mesure de coupure pour montage à fleur - Bord de 17mm de largeur:
Intaglio per montaggio a filo top - Larghezza bordo 17mm:

Bohrung für Zug- und Druckknöpfe Ø14
 Bohrung für Drehknopf Ø25

Trou pour boutons et Poussoirs de commande Ø14
 Trou pour bouton rotatif Ø25

Foro per Pomelli tiranti e Pomelli pulsanti Ø14
 Foro per Pomolo girevoli Ø25

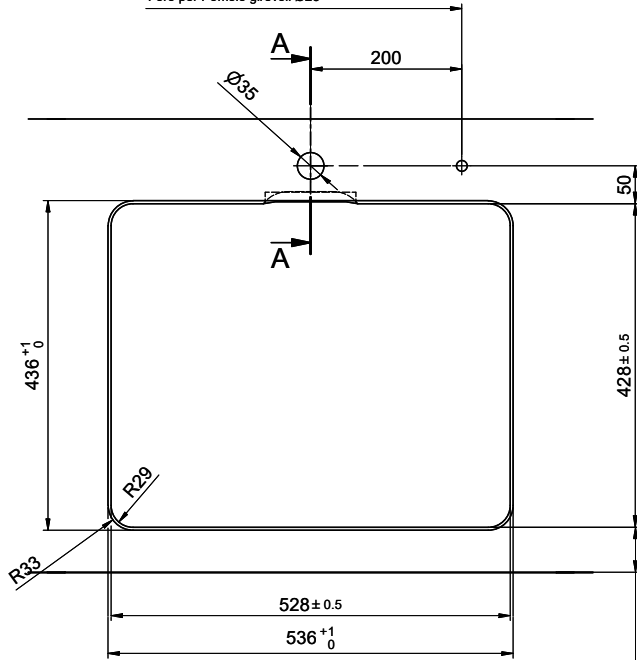

min. 60mm bei stehender Traverse.
 min. 80mm bei liegender Traverse.

min. 60mm avec traverse debout.
 min. 80mm avec traverse allongé.

min. 60mm con traversa stante.
 min. 80mm con traversa coricata.

Für 12mm Arbeitsplatte.
 Pour plan de travail de 12mm.
 Per piano di lavoro da 12mm

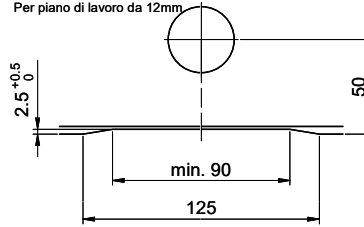

A-A (1 : 2)

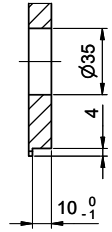

Für 13 - 30mm Arbeitsplatte.
 Pour plan de travail de 13 - 30mm.
 Per piano di lavoro da 13 - 30mm.

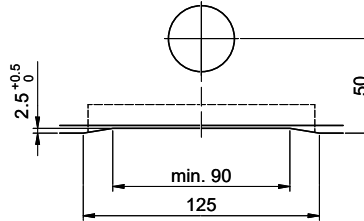

A-A (1 : 2)

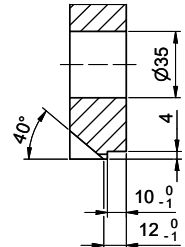

Für 13 - 50mm Arbeitsplatte.
 Pour plan de travail de 13 - 50mm.
 Per piano di lavoro da 13 - 50mm.

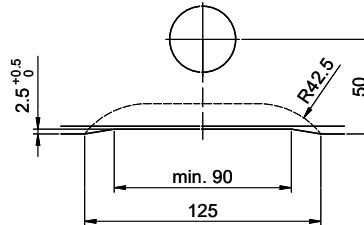

A-A (1 : 2)

