

Silver Star SIL 34/18U

> Weblink



**Montaggio**  
Lavelli sottopiano

**Modello**  
SIL 34/18U

**Materiale**  
Acciaio inox 18/10

**N. di articolo**  
10.103.621.00

**Dimensioni base**  
60 cm

**Piletta**  
3½" Salvaspazio

**Finitura**  
Lucido

**Prezzo in CHF**  
1'318.- IVA esclusa

**Dimensioni lavello**  
340x420x175mm

**Raggi d'angolo**  
50 mm

Tecnologia di scarico e troppopieno



Griglietta - tipo S



Troppopieno coperto

Premontaggio della piletta

Montaggio della piletta in fabbrica

Distributore - opzioni di montaggio

Posizione a scelta

Tecnologia di scarico e troppopieno

Pomolo inclusi



Prime

Prezzi (aggiornati al 05.05.26 / IVA esclusa)

Modello	Materiale	Piletta	Vasca per ra...	N. di articolo	Prezzo in CHF	
Silver Star SIL 18/34U	Acciaio inox 18/10, Opaco	3½" Tipo	Sinistra	10.103.092.00	1'277.-	> Weblink
	Acciaio inox 18/10, Lucido	3½" Tipo	Sinistra	10.103.619.00	1'277.-	> Weblink
	Acciaio inox 18/10, Opaco	3½" Tipo	Destra	10.103.093.00	1'277.-	> Weblink
	Acciaio inox 18/10, Lucido	3½" Tipo	Destra	10.103.622.00	1'277.-	> Weblink
	Acciaio inox 18/10, Opaco	3½" Salvaspazio	Sinistra	10.102.667.00	1'318.-	> Weblink
	Acciaio inox 18/10, Lucido	3½" Salvaspazio	Destra	10.103.621.00	1'318.-	> Weblink
	Acciaio inox 18/10, Opaco	3½" Salvaspazio	Destra	10.102.668.00	1'318.-	> Weblink
	Acciaio inox 18/10, Lucido	3½" Salvaspazio	Sinistra	10.103.618.00	1'318.-	> Weblink

Accessorio

Accessori opzionali



> Weblink  
40.000.914.00 / CHF  
106.-  
Vaschetta, forato



> Weblink  
40.001.290.00 / CHF  
106.-  
Vaschetta, non forato

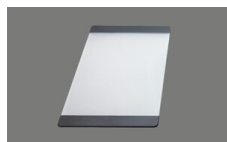

> Weblink  
40.000.915.00 / CHF  
151.-  
Tagliere, in vetro, bianco



> Weblink  
40.001.147.00 / CHF  
151.-  
Tagliere, in legno

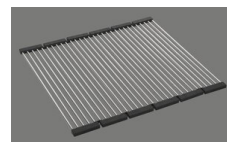

> Weblink  
40.001.138.00 / CHF  
125.-  
Inox Pad

Prodotti compatibili



> Weblink  
40.001.314.00 / CHF  
155.-  
Distributore Nano



> Weblink  
40.001.024.00 / CHF  
427.-  
Müllex Boxx 55/60-R Bio

Ricambi

Qui trovate tutti gli accessori compatibili > Weblink

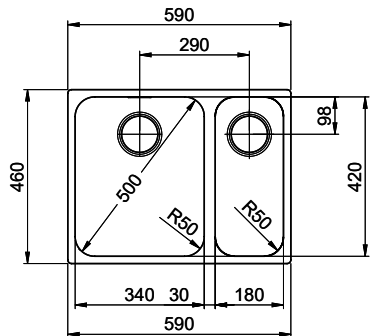

Bohrung für Zug- und Druckknöpfe ø14  
 Bohrung für Drehknopf ø25  
 Trou pour boutons et Pousoirs de commande ø14  
 Trou pour bouton rotatif ø25  
 Foro per Pomelli tiranti e Pomelli pulsanti ø14  
 Foro per Pomolo girevoli ø25

