

Silver Star SIS 50IF/12

> Weblink

Dimensioni base 55 cm

**Montaggio**

Lavelli a filo top / Lavelli sopra piano

Modello
SIS 50IF/12**Materiale**
Acciaio inox 18/10**N. di articolo**
10.104.264.00**Dimensioni base**
55 cm**Piletta**
3½" Tipo**Finitura**
Opaco**Prezzo in CHF**
1'009.- IVA esclusa**Dimensioni lavello**
500x420x175mm**Raggi d'angolo**
50 mm**Tecnologia di scarico e troppopieno**

Griglietta - tipo S



Troppopieno coperto

Premontaggio della piletta

Montaggio della piletta in fabbrica

Distributore - opzioni di montaggio

Posizione a scelta

Tecnologia di scarico e troppopieno**Pomolo inclusi****Prezzi (aggiornati al 06.05.26 / IVA esclusa)**

Modello	Materiale	Piletta	N. di articolo	Prezzo in CHF	
Silver Star SIS 50IF/12	Acciaio inox 18/10, Opaco	3½" Tipo	10.104.264.00	1'009.-	> Weblink
		3½" Salvaspazio	10.104.263.00	1'050.-	> Weblink

Descrizione del prodotto**Consegna dal 1.3.22 con larghezza del bordo 12 mm**

Con consegna dal 1.3.2022, questo modello ha una larghezza di bordo di 12mm. Si prega di notare le dimensioni di taglio modificate.

1 versione di prodotto, 2 metodi di montaggio

I modelli IF presentano un grande vantaggio: possono essere posati sia a filo top che sopra piano.

Montaggio a filo top: Consiglio per la scelta del piano di lavoro

Noi raccomandiamo il montaggio nei piani di lavoro in granito, pietra artificiale (per es. Corian o Varicor) oppure in legno massiccio. Sconsigliamo la posa nei piani di lavoro in resina sintetica.

Accessorio

Accessori opzionali

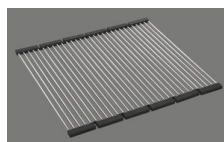
> Weblink
40.000.914.00 / CHF
106.-
Vaschetta, forato> Weblink
40.001.290.00 / CHF
106.-
Vaschetta, non forato> Weblink
40.000.915.00 / CHF
151.-
Tagliere, in vetro, bianco> Weblink
40.001.138.00 / CHF
125.-
Inox Pad> Weblink
40.001.147.00 / CHF
151.-
Tagliere, in legno

Silver Star SIS 50IF/12

[> Weblink](#)

Prodotti compatibili



[> Weblink](#)
40.001.314.00 / CHF
155.-
Distributore Nano



[> Weblink](#)
40.001.024.00 / CHF
427.-
Müllex Boxx 55/60-R Bio

Ricambi

Qui trovate tutti gli accessori compatibili [> Weblink](#)

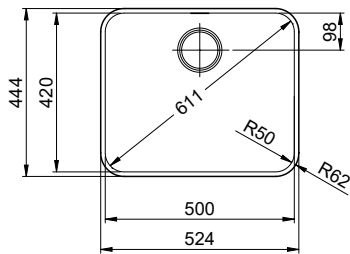

Für 12mm Arbeitsplatte.
 Pour plan de travail de 12mm.
 Per piano di lavoro da 12mm.

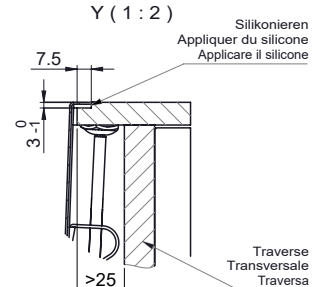
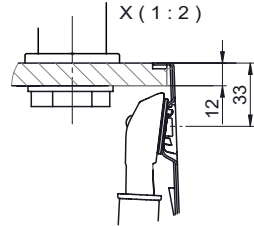

Für 13 - 30mm Arbeitsplatte.
 Pour plan de travail de 13 - 30mm.
 Per piano di lavoro da 13 - 30mm.

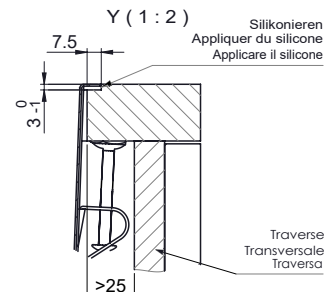
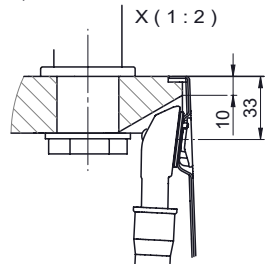

Für 13 - 50mm Arbeitsplatte.
 Pour plan de travail de 13 - 50mm.
 Per piano di lavoro da 13 - 50mm.

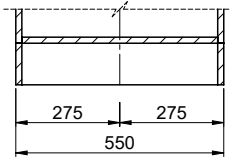
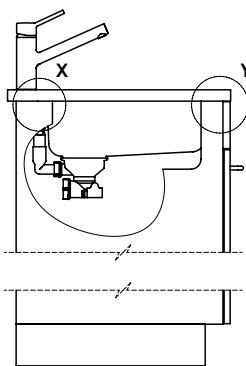
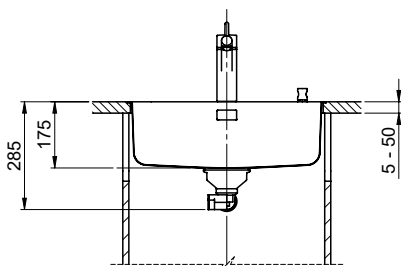
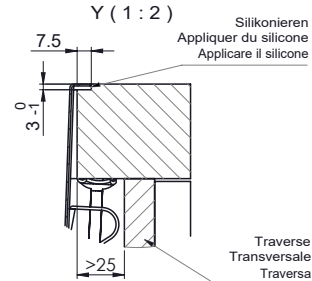
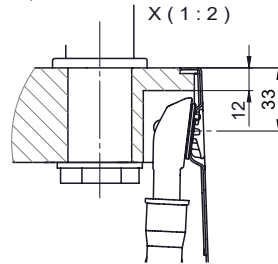

Bei der Planung die Traverse im Möbel beachten!
 Faites attention à la barre transversale dans les meubles lors de la planification!
 Presta attenzione alla traversa nei mobili durante la pianificazione!

Vom flächenbündigen Einbau in beschichteten Spanplatten raten wir ab.
 Nous vous déconseillons le montage à fleur sur des panneaux de particules enduits.
 Sconsigliamo il montaggio a filo top in pannelli di truciolato laminato.

Für dieses Dokument sind den eingetragenen Copyrights beizuhalten wie eine alle Rechte vorbehalten. Verwendungs, Belangung und
 andere Verwendung ohne schriftliche Zustimmung ist verboten. © Copyright 2020 Suter Inox AG. All rights reserved.

Bohrung für Zug- und Druckknöpfe ø14
 Bohrung für Drehknopf ø25

Trou pour boutons et Pouissoirs de commande ø14
 Trou pour bouton rotatif ø25

Foro per Pomelli tiranti e Pomelli pulsanti ø14
 Foro per Pomolo girevoli ø25

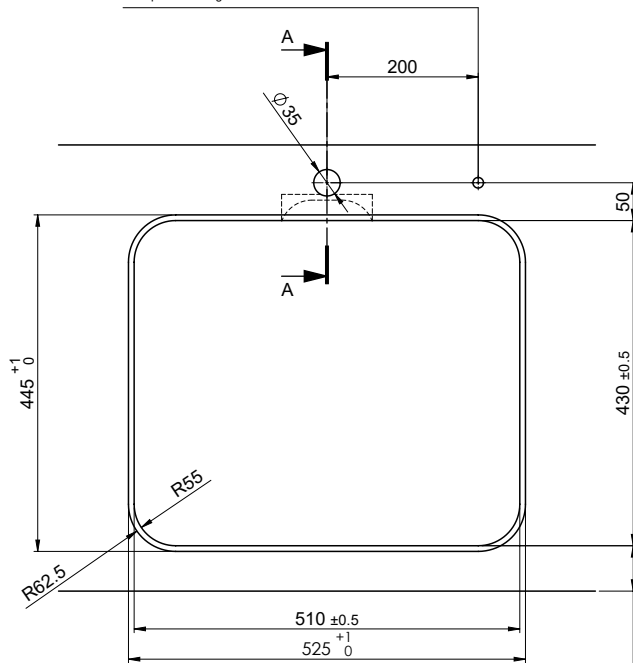

min. 60mm bei stehender Traverse
 min. 80mm bei liegender Traverse

min. 60mm avec traverse debout
 min. 80mm avec traverse allongé

min. 60mm con traversa stante
 min. 80mm con traversa coricata

Für 12mm Arbeitsplatte.
 Pour plan de travail de 12 mm.
 Per piano di lavoro da 12 mm.

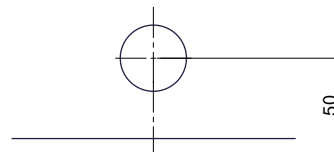

A-A (1 : 2)

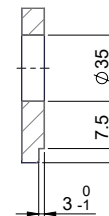

Für 13 - 30mm Arbeitsplatte.
 Pour plan de travail de 13 - 30mm.
 Per piano di lavoro da 13 - 30mm.

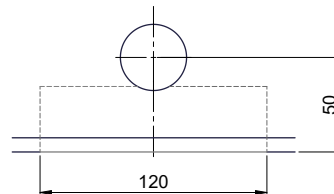

A-A (1 : 2)

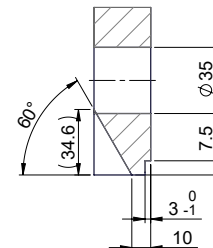

Für 13 - 50mm Arbeitsplatte.
 Pour plan de travail de 13 - 50mm.
 Per piano di lavoro da 13 - 50mm.

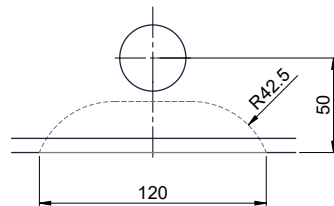

A-A (1 : 2)

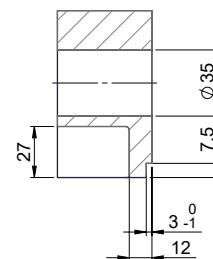

Bohrung für Zug- und Druckknöpfe ø14
 Bohrung für Drehknopf ø25

Trou pour boutons et Pousoirs de commande ø14
 Trou pour bouton rotatif ø25

Foro per Pomelli tiranti e Pomelli pulsanti ø14
 Foro per Pomolo girevoli ø25

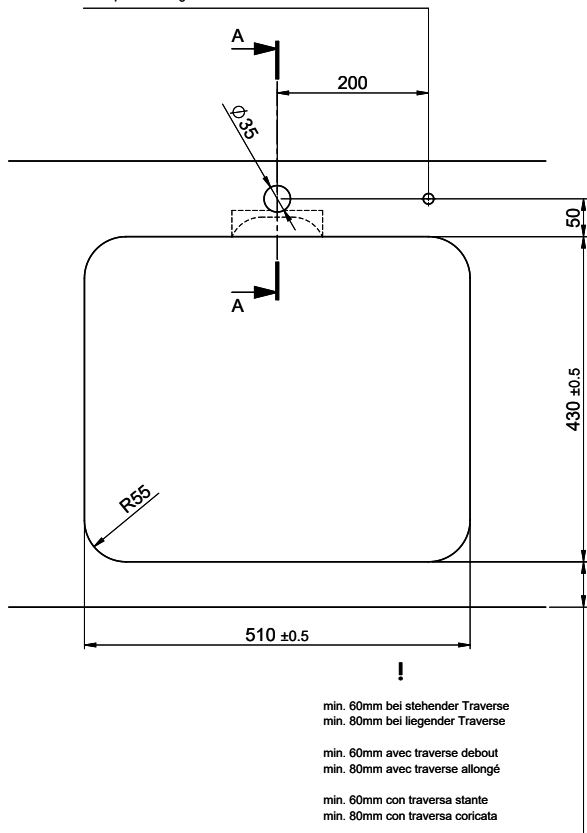

Für 12mm Arbeitsplatte.
 Pour plan de travail de 12 mm.
 Per piano di lavoro da 12 mm.

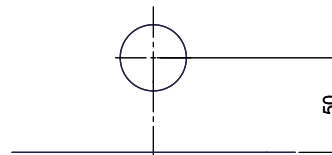

A-A (1 : 2)

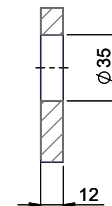

Für 13 - 30mm Arbeitsplatte.
 Pour plan de travail de 13 - 30mm.
 Per piano di lavoro da 13 - 30mm.

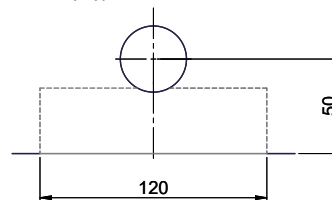

A-A (1 : 2)

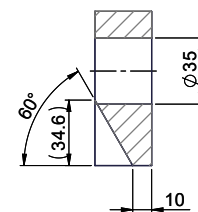

Für 13 - 50mm Arbeitsplatte.
 Pour plan de travail de 13 - 50mm.
 Per piano di lavoro da 13 - 50mm.

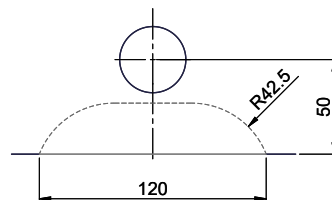

A-A (1 : 2)

