

Vantis V 50-42IF

> Weblink



Dimensioni base 55 cm

**Montaggio**  
Lavelli a filo top / Lavelli sopraiano

**Modello**  
V 50-42IF

**Materiale**  
Acciaio inox 18/10

**N. di articolo**  
10.105.212.00

**Dimensioni base**  
55 cm

**Piletta**  
3½" TouchFlow Desino

**Finitura**  
Opaco

**TRA**  
0.19

**Prezzo in CHF**  
1'387.- IVA esclusa

**Dimensioni lavello**  
500x420x175mm

**Raggi d'angolo**  
35 mm

Tecnologia di scarico e troppopieno



Desino: Scarico coperto con griglietta inferiore - tipo M



Placchetta di troppopieno a ribalta TouchFlow

Premontaggio della piletta

Premontaggio della piletta in fabbrica

Distributore - opzioni di montaggio

Posizione a scelta

Tecnologia di scarico e troppopieno

Pomolo inclusi

Prezzi (aggiornati al 06.05.26 / IVA esclusa)

Modello	Materiale	Piletta	N. di articolo	Prezzo in CHF	
Vantis V 50-42IF/12	Acciaio inox 18/10, Opaco	3½" Tipo Desino	10.105.749.00	1'177.-	> Weblink
		3½" Salvaspazio Desino	10.105.213.00	1'177.-	> Weblink
		3½" TouchFlow Desino	10.105.212.00	1'387.-	> Weblink
		3½" eFlow Desino	10.105.280.00	1'502.-	> Weblink

Descrizione del prodotto

1 versione di prodotto, 2 metodi di montaggio

I modelli IF presentano un grande vantaggio: possono essere posati sia a filo top che sopraiano.

Montaggio a filo top: Consiglio per la scelta del piano di lavoro

Consigliamo il montaggio nei piani di lavoro in ceramica, granito, pietra artificiale (per es. Corian o Varicor) oppure in legno massiccio. Sconsigliamo la posa in pannelli di truciolato rivestiti.

Pulizia

La griglietta per lo scarico Desino è lavabile in lavastoviglie e può essere pulita completamente o separatamente fino a una temperatura massima di 65 °C.

Accessorio

Accessori opzionali



> Weblink  
40.000.914.00 / CHF 106.-  
Vaschetta, forato



> Weblink  
40.001.147.00 / CHF 151.-  
Tagliere, in legno



> Weblink  
40.001.290.00 / CHF 106.-  
Vaschetta, non forato

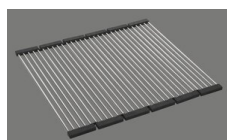

> Weblink  
40.001.138.00 / CHF 125.-  
Inox Pad



> Weblink  
40.000.915.00 / CHF 151.-  
Tagliere, in vetro, bianco

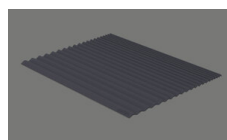

> Weblink  
40.002.008.00 / CHF 51.-  
Maro tappetino scolapiatti, Dark Grey

**Vantis V 50-42IF** [> Weblink](#)

**Ricambi**

Qui trovate tutti gli accessori compatibili [> Weblink](#)

# Vantis V 50-42IF/12 Desino

**Randbreite 12mm**  
**Bord de 12mm de largeur**  
**Larghezza bordo 12mm**



Für 12mm Arbeitsplatte.  
 Pour plan de travail de 12mm.  
 Per piano di lavoro da 12mm.



Für 13 - 30mm Arbeitsplatte.  
 Pour plan de travail de 13 - 30mm.  
 Per piano di lavoro da 13 - 30mm.

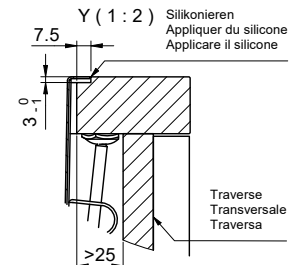
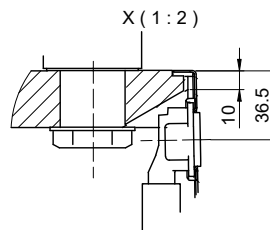

Für 13 - 50mm Arbeitsplatte.  
 Pour plan de travail de 13 - 50mm.  
 Per piano di lavoro da 13 - 50mm.

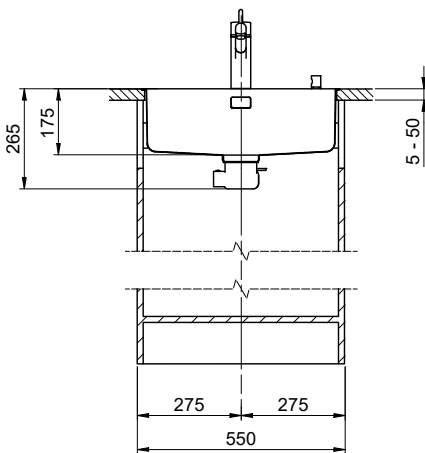
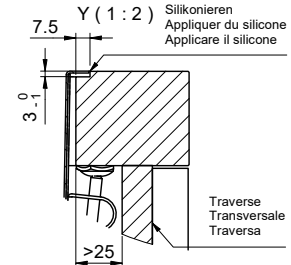

Bei der Planung die Traverse im Möbel beachten!

Faites attention à la barre transversale dans les meubles lors de la planification!

Presta attenzione alla traversa nei mobili durante la pianificazione!

Vom flächenbündigen Einbau in beschichtete Spanplatten raten wir ab.

Nous vous déconseillons le montage à fleur sur des panneaux de particules enduits.

Sconsigliamo il montaggio a filo top in pannelli di truciolato laminato.

# Vantis V 50-42IF/12 Desino

Ausschnitt für flächenbündigen Einbau - Randbreite 12mm:  
 Mesure de coupe pour montage à fleur - Bord de 12mm de largeur:  
 Intaglio per montaggio a filo top - Larghezza bordo 12mm:

Bohrung für Zug- und Druckknöpfe Ø14  
 Bohrung für Drehknopf Ø25  
 Trou pour boutons et Pousoirs de commande Ø14  
 Trou pour bouton rotatif Ø25  
 Foro per Pomelli tiranti e Pomelli pulsanti Ø14  
 Foro per Pomolo girevoli Ø25

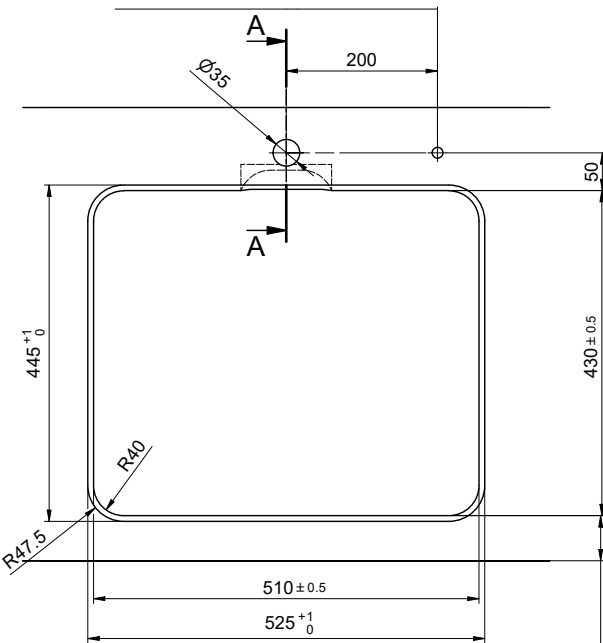

!  
 min. 60mm bei stehender Traverse.  
 min. 80mm bei liegender Traverse.  
 min. 60mm avec traverse debout.  
 min. 80mm avec traverse allongé.  
 min. 60mm con traversa stante.  
 min. 80mm con traversa coricata.

Für 12mm Arbeitsplatte.  
 Pour plan de travail de 12mm.  
 Per piano di lavoro da 12mm.

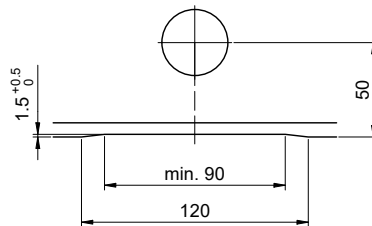

A-A (1 : 2)

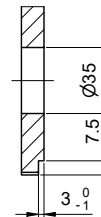

Für 13 - 30mm Arbeitsplatte.  
 Pour plan de travail de 13 - 30mm.  
 Per piano di lavoro da 13 - 30mm.

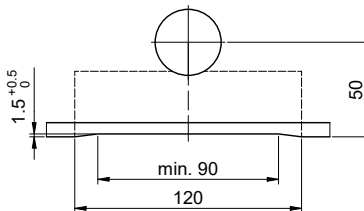

A-A (1 : 2)

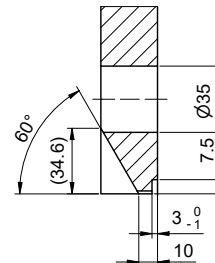

Für 13 - 50mm Arbeitsplatte.  
 Pour plan de travail de 13 - 50mm.  
 Per piano di lavoro da 13 - 50mm.

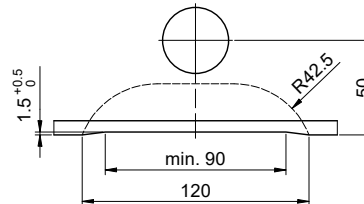

A-A (1 : 2)

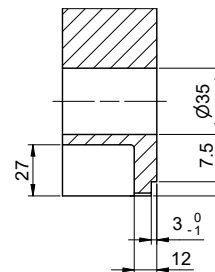

# Vantis V 50-42IF/12 Desino

**Ausschnitt für aufliegenden Einbau - Randbreite 12mm:**  
**Mesure de coupe pour montage en appui - Bord de 12mm de largeur:**  
**Intaglio per montaggio soprapiano - Larghezza bordo 12mm:**

Bohrung für Zug- und Druckknöpfe Ø14  
 Bohrung für Drehknopf Ø25

Trou pour boutons et Poussoirs de commande Ø14  
 Trou pour bouton rotatif Ø25

Foro per Pomelli tiranti e Pomelli pulsanti Ø14  
 Foro per Pomolo girevoli Ø25

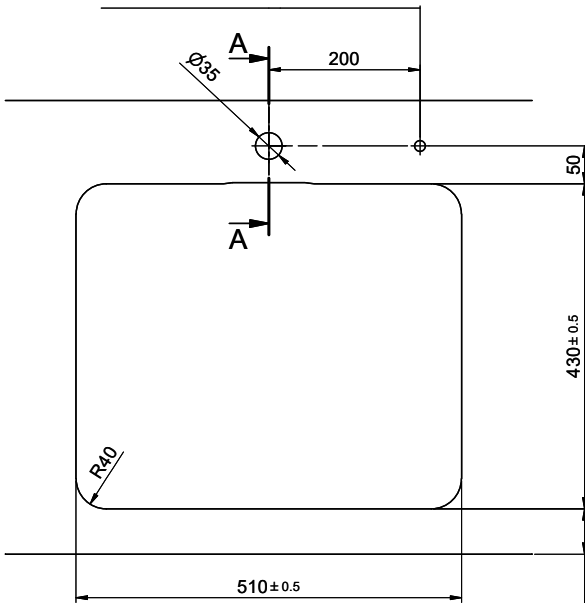

!  
 min. 60mm bei stehender Traverse.  
 min. 80mm bei liegender Traverse.  
 min. 60mm avec traverse debout.  
 min. 80mm avec traverse allongé.  
 min. 60mm con traversa stante.  
 min. 80mm con traversa coricata.

Für 12mm Arbeitsplatte.  
 Pour plan de travail de 12mm.  
 Per piano di lavoro da 12mm.

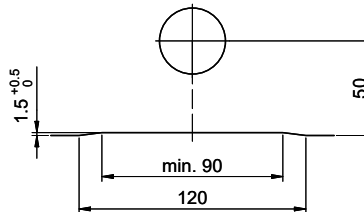

A-A (1 : 2)

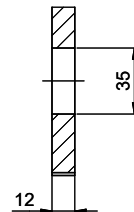

Für 13 - 30mm Arbeitsplatte.  
 Pour plan de travail de 13 - 30mm.  
 Per piano di lavoro da 13 - 30mm.

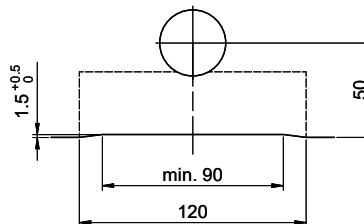

A-A (1 : 2)

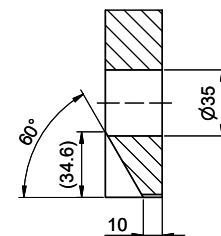

Für 13 - 50mm Arbeitsplatte.  
 Pour plan de travail de 13 - 50mm.  
 Per piano di lavoro da 13 - 50mm.

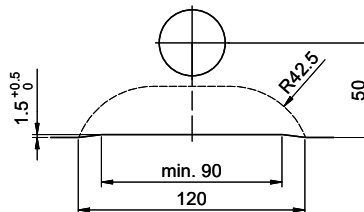

A-A (1 : 2)

