

Vantis V 50-42IF/12

> Weblink



**Montaggio**  
Lavelli a filo top / Lavelli sopraiano

**Modello**  
V 50-42IF/12

**Materiale**  
Acciaio inox 18/10

**N. di articolo**  
10.104.237.00

**Dimensioni base**  
55 cm

**Piletta**  
3½" Salvaspazio

**Finitura**  
Opaco

**Prezzo in CHF**  
1'037.- IVA esclusa

**Dimensioni lavello**  
500x420x175mm

**Raggi d'angolo**  
35 mm

Tecnologia di scarico e troppopieno



Griglietta - tipo S



Placchetta di troppopieno a ribalta

Premontaggio della piletta

Montaggio della piletta in fabbrica

Distributore - opzioni di montaggio

Posizione a scelta

Tecnologia di scarico e troppopieno

Pomolo inclusi



Prime

Prezzi (aggiornati al 14.05.26 / IVA esclusa)

Modello	Materiale	Piletta	N. di articolo	Prezzo in CHF	
Vantis V 50-42IF/12	Acciaio inox 18/10, Opaco	3½" Tipo	10.104.238.00	988.-	> Weblink
		3½" Salvaspazio	10.104.237.00	1'037.-	> Weblink
		3½" TouchFlow	10.104.236.00	1'235.-	> Weblink

Descrizione del prodotto

1 versione di prodotto, 2 metodi di montaggio

I modelli IF presentano un grande vantaggio: possono essere posati sia a filo top che sopraiano.

Montaggio a filo top: Consiglio per la scelta del piano di lavoro

Consigliamo il montaggio nei piani di lavoro in ceramica, granito, pietra artificiale (per es. Corian o Varicor) oppure in legno massiccio. Sconsigliamo la posa in pannelli di truciolato rivestiti.

Accessorio

Accessori opzionali



> Weblink  
40.001.147.00 / CHF  
151.-  
Tagliere, in legno

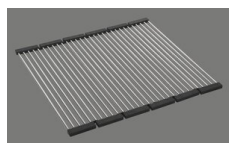

> Weblink  
40.001.138.00 / CHF  
125.-  
Inox Pad



> Weblink  
40.000.914.00 / CHF  
106.-  
Vaschetta, forato



> Weblink  
40.001.290.00 / CHF  
106.-  
Vaschetta, non forato

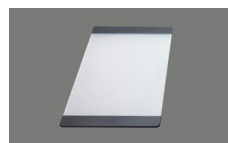

> Weblink  
40.000.915.00 / CHF  
151.-  
Tagliere, in vetro, bianco

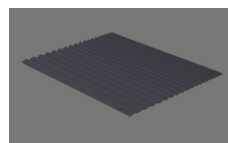

> Weblink  
40.002.008.00 / CHF 51.-  
Maro tappetino scolapiatti, Dark Grey

Ricambi

Qui trovate tutti gli accessori compatibili > Weblink

# Vantis V 50-421F/12

**Randbreite 12mm**  
**Bord de 12mm de largeur**  
**Larghezza bordo 12mm**

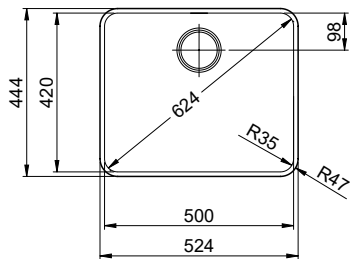

Für 12mm Arbeitsplatte.  
 Pour plan de travail de 12mm.  
 Per piano di lavoro da 12mm.

X (1 : 2)

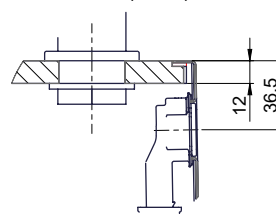

Y (1 : 2)

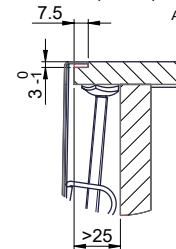

Silikonieren  
 Appliquer du silicone  
 Applicare il silicone

Traverse  
 Transversale  
 Traversa

Für 13 - 30mm Arbeitsplatte.  
 Pour plan de travail de 13 - 30mm.  
 Per piano di lavoro da 13 - 30mm.

X (1 : 2)

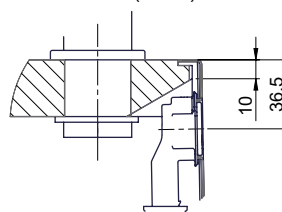

Y (1 : 2)

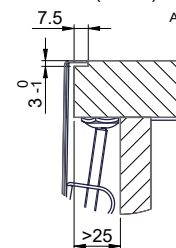

Silikonieren  
 Appliquer du silicone  
 Applicare il silicone

Traverse  
 Transversale  
 Traversa

Für 13 - 50mm Arbeitsplatte.  
 Pour plan de travail de 13 - 50mm.  
 Per piano di lavoro da 13 - 50mm.

X (1 : 2)

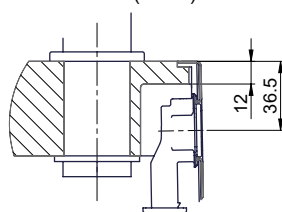

Y (1 : 2)

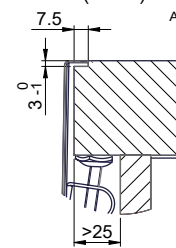

Silikonieren  
 Appliquer du silicone  
 Applicare il silicone

Traverse  
 Transversale  
 Traversa

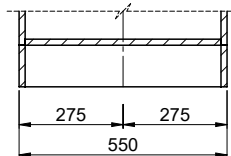
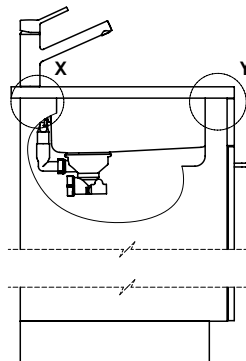
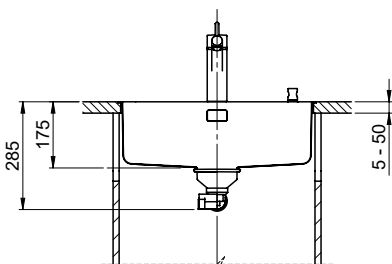

Bei der Planung die Traverse im Möbel beachten!

Faites attention à la barre transversale dans les meubles lors de la planification!

Presta attenzione alla traversa nei mobili durante la pianificazione!

Vom flächenbündigen Einbau in beschichteten Spanplatten raten wir ab.

Nous vous déconseillons le montage à fleur sur des panneaux de particules enduits.

Sconsigliamo il montaggio a filo top in pannelli di truciolato laminato.

# Vantis V 50-42IF/12

Ausschnitt für flächenbündigen Einbau - Randbreite 12mm:  
 Mesure de coupe pour montage à fleur - Bord de 12mm de largeur:  
 Intaglio per montaggio a filo top - Larghezza bordo 12mm:

Bohrung für Zug- und Druckknöpfe ø14  
 Bohrung für Drehknopf ø25

Trou pour boutons et Poussoirs de commande ø14  
 Trou pour bouton rotatif ø25

Foro per Pomelli tiranti e Pomelli pulsanti ø14  
 Foro per Pomolo girevoli ø25

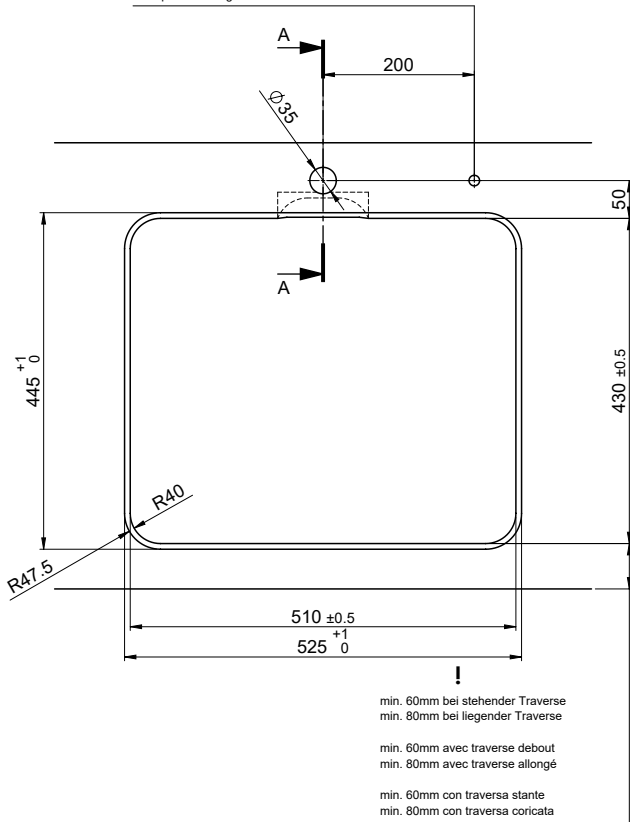

min. 60mm bei stehender Traverse  
 min. 80mm bei liegender Traverse

min. 60mm avec traverse debout  
 min. 80mm avec traverse allongé

min. 60mm con traversa stante  
 min. 80mm con traversa coricata

Für 12mm Arbeitsplatte.  
 Pour plan de travail de 12 mm.  
 Per piano di lavoro da 12 mm.

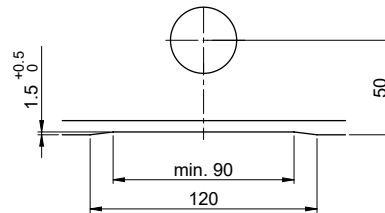

A-A ( 1 : 2 )

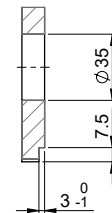

Für 13 - 30mm Arbeitsplatte.  
 Pour plan de travail de 13 - 30mm.  
 Per piano di lavoro da 13 - 30mm.

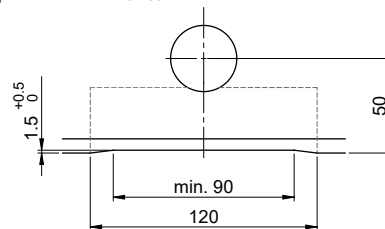

A-A ( 1 : 2 )

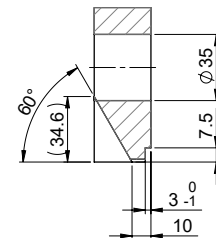

Für 13 - 50mm Arbeitsplatte.  
 Pour plan de travail de 13 - 50mm.  
 Per piano di lavoro da 13 - 50mm.

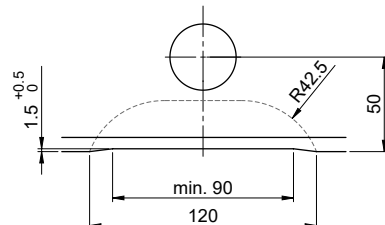

A-A ( 1 : 2 )

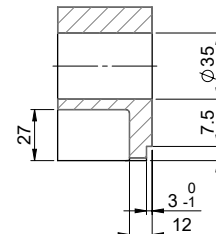

Bohrung für Zug- und Druckknöpfe ø14  
 Bohrung für Drehknopf ø25

Trou pour boutons et Poussoirs de commande ø14  
 Trou pour bouton rotatif ø25

Foro per Pomelli tiranti e Pomelli pulsanti ø14  
 Foro per Pomolo girevoli ø25

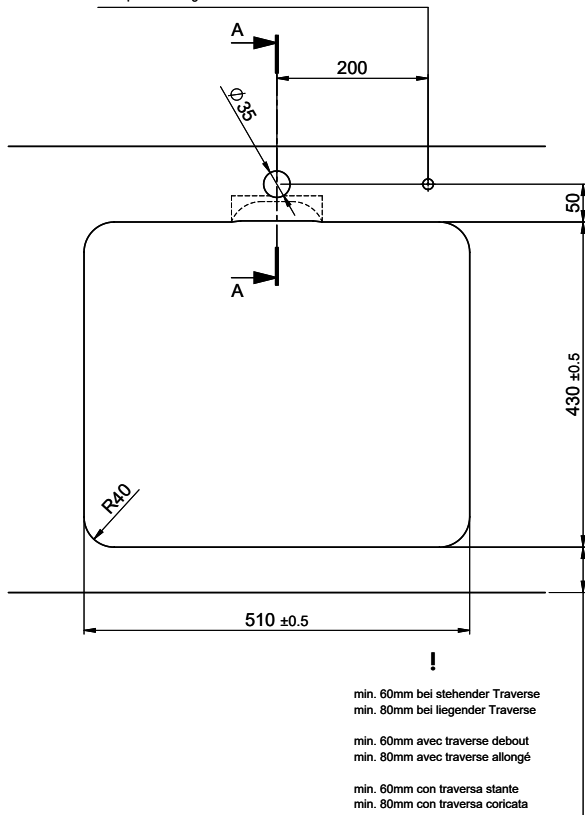

Für 12mm Arbeitsplatte.  
 Pour plan de travail de 12 mm.  
 Per piano di lavoro da 12 mm.

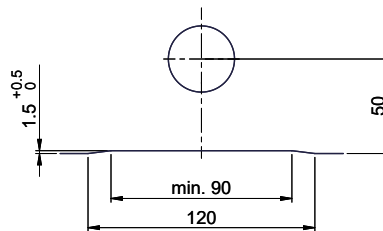

A-A (1 : 2)

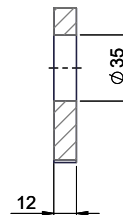

Für 13 - 30mm Arbeitsplatte.  
 Pour plan de travail de 13 - 30mm.  
 Per piano di lavoro da 13 - 30mm.

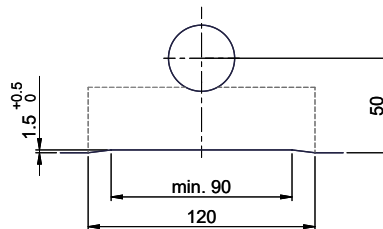

A-A (1 : 2)

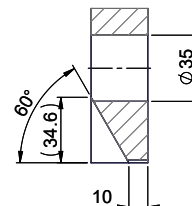

Für 13 - 50mm Arbeitsplatte.  
 Pour plan de travail de 13 - 50mm.  
 Per piano di lavoro da 13 - 50mm.

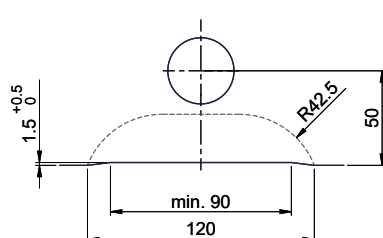

A-A (1 : 2)

