

Vantis VX 50-42IF/15 Varix

[> Weblink](#)

Dimensioni base 55 cm

**Montaggio**

Lavelli a filo top / Lavelli sopra piano

Modello

VX 50-42IF/15 Varix

Materiale

Acciaio inox 18/10

N. di articolo

10.104.160.00

Dimensioni base

55 cm

Piletta

3½" A tappo c.griglietta

Finitura

Mid-matt

Prezzo in CHF

745.- IVA esclusa

Dimensioni lavello

500x420x160mm

Raggi d'angolo

35 mm

Tecnologia di scarico e troppopieno

Troppopieno coperto

Premontaggio della piletta

Montaggio della piletta in fabbrica

Distributore - opzioni di montaggio

Posizione a scelta

Tecnologia di scarico e troppopieno**Pomolo inclusi****Prezzi (aggiornati al 21.06.26 / IVA esclusa)**

Modello	Materiale	Piletta	N. di articolo	Prezzo in CHF	
Vantis VX 50-42IF/15 Varix	Acciaio inox 18/10, Mid-matt	3½" A tappo c.griglietta	10.104.160.00	745.-	> Weblink
		3½" Salvaspazio	10.104.159.00	794.-	> Weblink

Descrizione del prodotto**1 versione di prodotto, 2 metodi di montaggio**

I modelli IF presentano un grande vantaggio: possono essere posati sia a filo top che sopra piano.

Montaggio a filo top: Consiglio per la scelta del piano di lavoro

Consigliamo il montaggio nei piani di lavoro in ceramica, granito, pietra artificiale (per es. Corian o Varicor) oppure in legno massiccio. Sconsigliamo la posa in pannelli di truciolato rivestiti.

Accessorio

Accessori opzionali



[> Weblink](#)
40.000.914.00 / CHF
106.-
Vaschetta, forato



[> Weblink](#)
40.001.290.00 / CHF
106.-
Vaschetta, non forato



[> Weblink](#)
40.000.915.00 / CHF
151.-
Tagliere, in vetro, bianco



[> Weblink](#)
40.001.147.00 / CHF
151.-
Tagliere, in legno

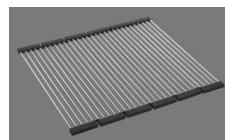

[> Weblink](#)
40.001.138.00 / CHF
125.-
Inox Pad

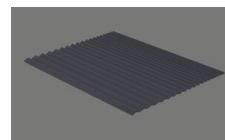

[> Weblink](#)
40.002.008.00 / CHF 51.-
Maro tappetino
scolapiatti, Dark Grey

RicambiQui trovate tutti gli accessori compatibili [> Weblink](#)

Vantis VX 50-42IF/15 Varix

Ausschnitt für flächenbündigen Einbau - Randbreite 15mm:
 Mesure de coupe pour montage à fleur - Bord de 15mm de largeur:
 Intaglio per montaggio a filo top - Larghezza bordo 15mm:

Bohrung für Zug- und Druckknöpfe ø14
 Bohrung für Drehknopf ø25

Trou pour boutons et Pousoirs de commande ø14
 Trou pour bouton rotatif ø25

Foro per Pomelli tiranti e Pomelli pulsanti ø14
 Foro per Pomolo girevoli ø25

Für 12mm Arbeitsplatte.
 Pour plan de travail de 12 mm.
 Per piano di lavoro da 12 mm.

A-A (1 : 2)

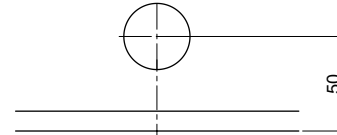
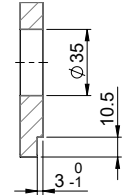

Für 13 - 30mm Arbeitsplatte.
 Pour plan de travail de 13 - 30mm.
 Per piano di lavoro da 13 - 30mm.

A-A (1 : 2)

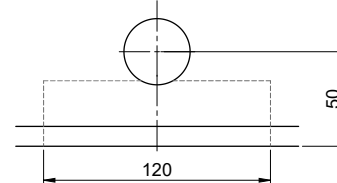
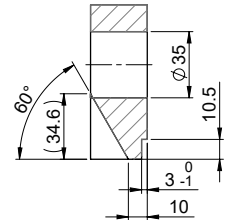

Für 13 - 50mm Arbeitsplatte.
 Pour plan de travail de 13 - 50mm.
 Per piano di lavoro da 13 - 50mm.

A-A (1 : 2)

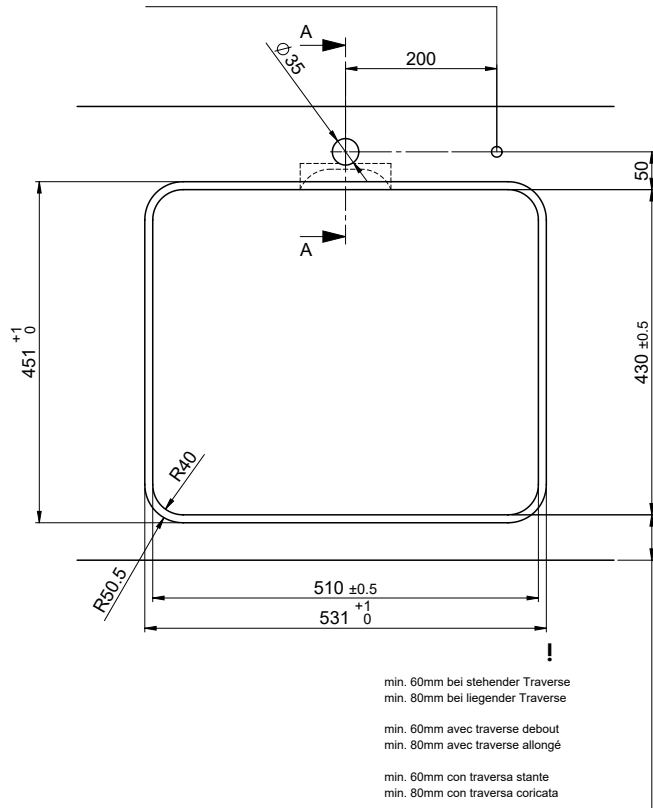
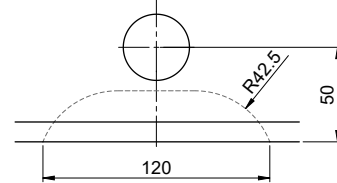
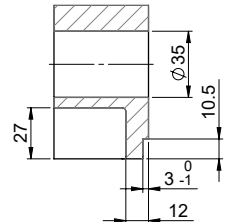

min. 60mm bei stehender Traverse
 min. 80mm bei liegender Traverse

min. 60mm avec traverse debout
 min. 80mm avec traverse allongé

min. 60mm con traversa stante
 min. 80mm con traversa coricata

Vantis VX 50-42IF/15 Varix

Ausschnitt für flach aufliegender Einbau - Randbreite 15mm:
 Mesure de coupure pour montage en appui - Bord de 15mm de largeur:
 Intaglio per montaggio soprapiano - Larghezza bordo 15mm:

Bohrung für Zug- und Druckknöpfe ø14
 Bohrung für Drehknopf ø25

Trou pour boutons et Pousoirs de commande ø14
 Trou pour bouton rotatif ø25

Foro per Pomelli tiranti e Pomelli pulsanti ø14
 Foro per Pomolo girevoli ø25

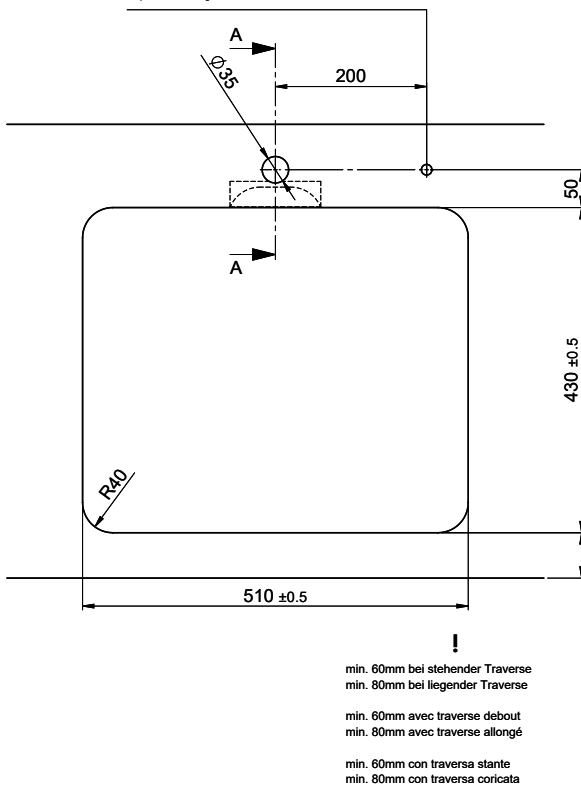

Für 12mm Arbeitsplatte.
 Pour plan de travail de 12 mm.
 Per piano di lavoro da 12 mm.

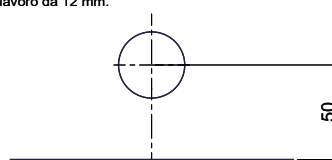

A-A (1 : 2)

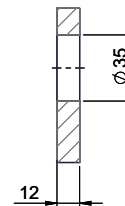

Für 13 - 30mm Arbeitsplatte.
 Pour plan de travail de 13 - 30mm.
 Per piano di lavoro da 13 - 30mm.

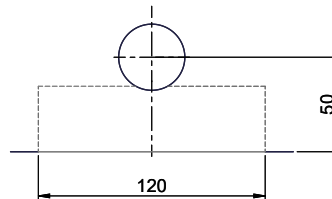

A-A (1 : 2)

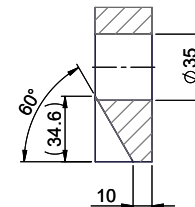

Für 13 - 50mm Arbeitsplatte.
 Pour plan de travail de 13 - 50mm.
 Per piano di lavoro da 13 - 50mm.

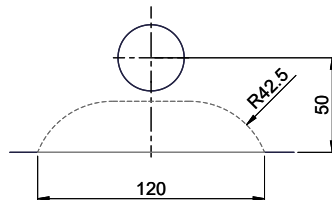

A-A (1 : 2)

