

**Comfort COM 34**

[> Weblink](#)



**Einbauart**  
Einlege-Spülen  
**Modell**  
COM 34  
**Material**  
Edelstahl 18/10  
**Artikel Nr.**  
10.103.102.00

**Unterschrank**  
40 cm  
**Ventil**  
3½" Tipo  
**Oberfläche**  
Glanz  
**Preis CHF**  
830.- exkl. MwSt

**Beckendimensionen**  
340x420x175mm  
**Beckenradius**  
50 mm

**Ab- und Überlauftechnik**



Sieb - Typ S



Verdeckter Überlauf

**Ventilvormontage**  
Ventilmontage ab Werk

**Dispenser-Einbauoption**  
Frei positionierbar

**Ab- und Überlauftechnik**  
Standard-Zugknopf

**Preise (Stand 21.06.26 / exkl. MwSt)**

Modell	Material	Ventil	Artikel Nr.	Preis CHF
Comfort COM 34	Edelstahl 18/10, Glanz	3½" Tipo	10.103.102.00	830.- > Weblink
		3½" Raumspar	10.102.726.00	871.- > Weblink

**Zubehör**

Optionales Zubehör



> Weblink  
40.001.004.00 / CHF 42.-  
Resteschale, gelocht



> Weblink  
40.000.971.00 / CHF 106.-  
Resteschale, gelocht

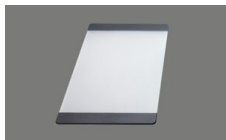

> Weblink  
40.000.915.00 / CHF 151.-  
Schneidebrett, aus Glas, weiss

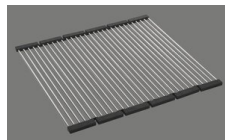

> Weblink  
40.001.138.00 / CHF 125.-  
Inox Pad

**Passende Artikel**



> Weblink  
40.001.314.00 / CHF 155.-  
Dispenser Nano



> Weblink  
40.001.023.00 / CHF 347.-  
Müllex Boxx 40-R

**Ersatzteile**

Passende Ersatzteile finden Sie hier [> Weblink](#)

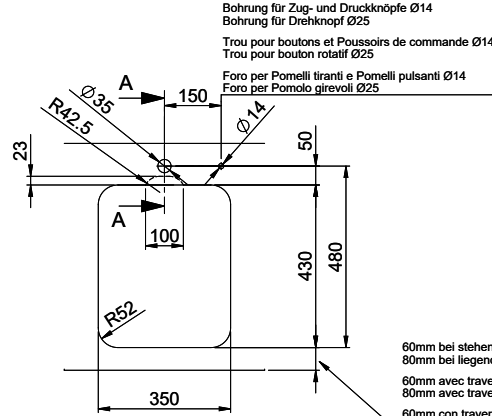
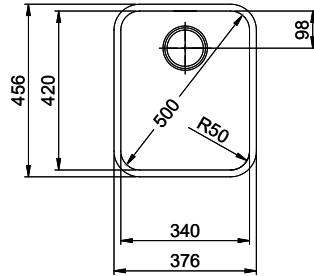

**A-A**  
**MAßSTAB 1 : 2**

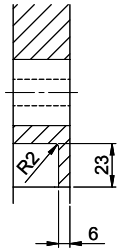

- 60mm bei stehender Traverse
- 80mm bei liegender Traverse
- 60mm avec traverse allongé
- 80mm avec traverse debout
- 60mm con traversa coricata
- 80mm con traversa stante

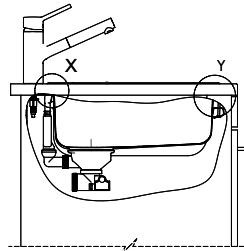
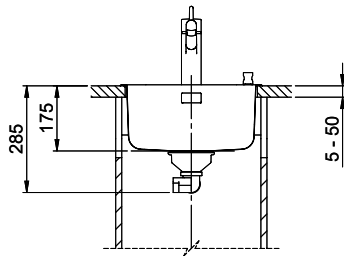

**DETAIL X**  
**MAßSTAB 1 : 2**

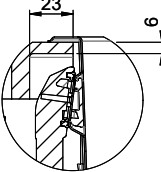

**DETAIL Y**  
**MAßSTAB 1 : 2**

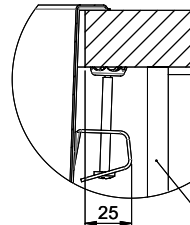

**Achtung: Traverse vorne beachten!**  
**Attention: respecter la traverse avant!**  
**Attenzione: rispettare la traversa avanti!**

