

**Linero LIO 40F/7**
[> Weblink](#)

**Einbauart**  
Flächenbündige-Spüle

**Modell**  
LIO 40F/7

**Material**  
Edelstahl 18/10

**Artikel Nr.**  
10.105.660.00

**Unterschrank**  
45 cm

**Ventil**  
3½" TouchFlow

**Oberfläche**  
Matt

**VRG**  
0.19

**Preis CHF**  
1'632.- exkl. MwSt

**Beckendimensionen**  
400x400x175mm

**Beckenradius**  
15 mm

**Ab- und Überlauftechnik**

Sieb - Typ M

 Schwenkbare  
Überlaufkappe  
TouchFlow

**Ventilvormontage**

Ventilvormontage ab Werk

**Dispenser-Einbauoption**

Frei positionierbar

**Ab- und Überlauftechnik**
**Preise (Stand 06.05.26 / exkl. MwSt)**

Modell	Material	Ventil	Artikel Nr.	Preis CHF
Linero LIO 40F/7	Edelstahl 18/10, Matt	3½" Tipo	10.105.662.00	1'393.- > Weblink
		3½" Raumspar	10.105.661.00	1'434.- > Weblink
		3½" Raumspar	10.106.242.00	1'479.- > Weblink
		3½" TouchFlow	10.105.660.00	1'632.- > Weblink

**Zubehör**

## Optionales Zubehör

 > Weblink  
40.000.912.00 / CHF  
106.-  
Resteschale, gelocht

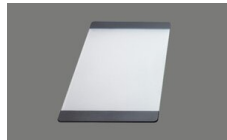
 > Weblink  
40.001.289.00 / CHF  
106.-  
Resteschale, ungelocht

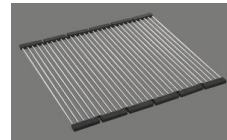
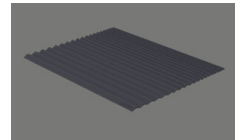
 > Weblink  
40.000.909.00 / CHF  
151.-  
Schneidebrett, aus Glas,  
weiss

 > Weblink  
40.001.277.00 / CHF  
151.-  
Schneidebrett, aus  
Kunststoff

 > Weblink  
40.001.138.00 / CHF  
125.-  
Inox Pad

 > Weblink  
40.002.008.00 / CHF 51.-  
Maro Abtropfmatte, Dark  
Grey

**Ersatzteile**

 Passende Ersatzteile finden Sie hier [> Weblink](#)

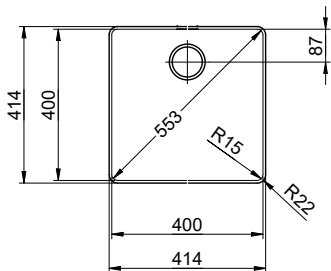
# Linero LIO 40F/7 Desino

Randbreite 7mm  
 Bord de 7mm de largeur  
 Larghezza bordo 7mm



Für 12mm Arbeitsplatte.  
 Pour plan de travail de 12mm.  
 Per piano di lavoro da 12mm.



Für 13 - 30mm Arbeitsplatte.  
 Pour plan de travail de 13 - 30mm.  
 Per piano di lavoro da 13 - 30mm.

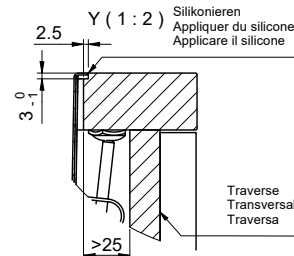
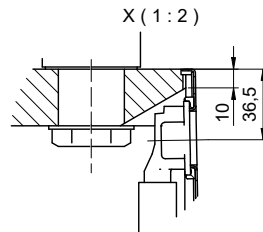

Für 13 - 50mm Arbeitsplatte.  
 Pour plan de travail de 13 - 50mm.  
 Per piano di lavoro da 13 - 50mm.

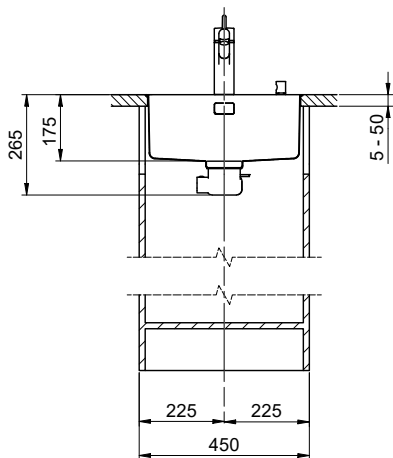
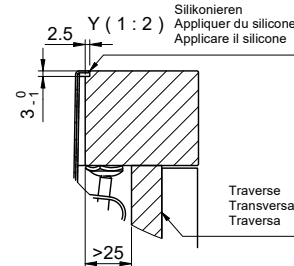
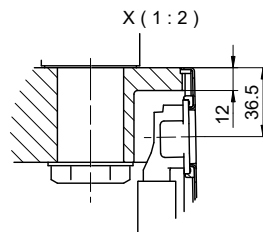

Bei der Planung die Traverse im Möbel beachten!

Faites attention à la barre transversale dans les meubles lors de la planification!

Presta attenzione alla traversa nei mobili durante la pianificazione!

Vom flächenbündigen Einbau in beschichtete Spanplatten raten wir ab.

Nous vous déconseillons le montage à fleur sur des panneaux de particules enduits.

Sconsigliamo il montaggio a filo top in pannelli di truciolato laminato.

# Linero LIO 40F/7 Desino

**Ausschnitt für flächenbündigen Einbau - Randbreite 7mm:**  
**Mesure de coupure pour montage à fleur - Bord de 7mm de largeur:**  
**Intaglio per montaggio a filo top - Larghezza bordo 7mm:**

Bohrung für Zug- und Druckknöpfe Ø14  
 Bohrung für Drehknopf Ø25

Trou pour boutons et Pousoirs de commande Ø14  
 Trou pour bouton rotatif Ø25

Foro per Pomelli tiranti e Pomelli pulsanti Ø14  
 Foro per Pomolo girevoli Ø25



min. 60mm bei stehender Traverse.  
 min. 80mm bei liegender Traverse.

min. 60mm avec traverse debout.  
 min. 80mm avec traverse allongé.

min. 60mm con traversa slante.  
 min. 80mm con traversa coricata.

Für 12mm Arbeitsplatte.  
 Pour plan de travail de 12mm.  
 Per piano di lavoro da 12mm.

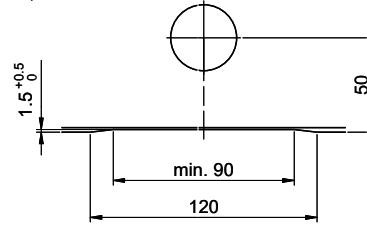

A-A (1 : 2)

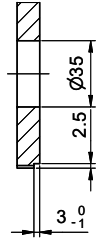

Für 13 - 30mm Arbeitsplatte.  
 Pour plan de travail de 13 - 30mm.  
 Per piano di lavoro da 13 - 30mm.

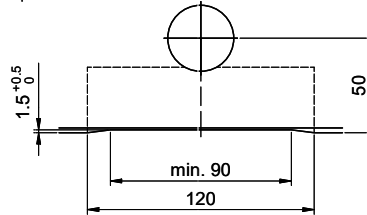

A-A (1 : 2)

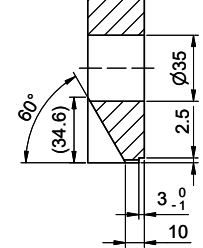

Für 13 - 50mm Arbeitsplatte.  
 Pour plan de travail de 13 - 50mm.  
 Per piano di lavoro da 13 - 50mm.

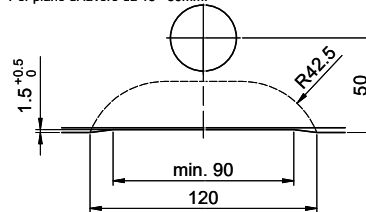

A-A (1 : 2)

