

Linero LIO 45F/7

[> Weblink](#)



Einbauart
Flächenbündige-Spüle

Modell
LIO 45F/7

Material
Edelstahl 18/10

Artikel Nr.
10.105.666.00

Unterschrank
50 cm

Ventil
3½" Tipo

Oberfläche
Matt

Preis CHF
1'424.- exkl. MwSt

Beckendimensionen
450x400x175mm

Beckenradius
15 mm

Ab- und Überlauftechnik



Sieb - Typ M



Schwenkbare
Überlaufkappe

Ventilvormontage
Ventilvormontage ab Werk

Dispenser-Einbauoption
Frei positionierbar

Ab- und Überlauftechnik

Preise (Stand 06.05.26 / exkl. MwSt)

Modell	Material	Ventil	Artikel Nr.	Preis CHF
Linero LIO 45F/7	Edelstahl 18/10, Matt	3½" Tipo	10.105.666.00	1'424.- > Weblink
		3½" Raumspar	10.105.665.00	1'465.- > Weblink
		3½" Raumspar	10.106.243.00	1'510.- > Weblink
		3½" TouchFlow	10.105.664.00	1'663.- > Weblink

Zubehör

Optionales Zubehör



> Weblink
40.000.912.00 / CHF
106.-
Resteschale, gelocht



> Weblink
40.001.289.00 / CHF
106.-
Resteschale, ungelocht



> Weblink
40.000.909.00 / CHF
151.-
Schneidebrett, aus Glas,
weiss



> Weblink
40.001.277.00 / CHF
151.-
Schneidebrett, aus
Kunststoff



> Weblink
40.001.138.00 / CHF
125.-
Innox Pad

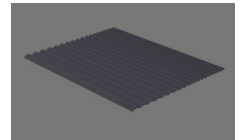

> Weblink
40.002.008.00 / CHF 51.-
Maro Abtropfmatte, Dark
Grey

Ersatzteile

Passende Ersatzteile finden Sie hier [> Weblink](#)

Linero LIO 45F/7 Desino

Randbreite 7mm
Bord de 7mm de largeur
Larghezza bordo 7mm

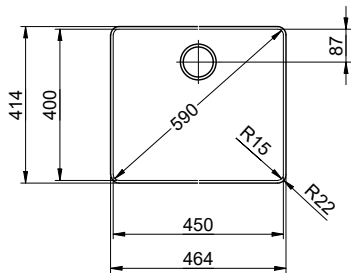

Für 12mm Arbeitsplatte.
 Pour plan de travail de 12mm.
 Per piano di lavoro da 12mm.

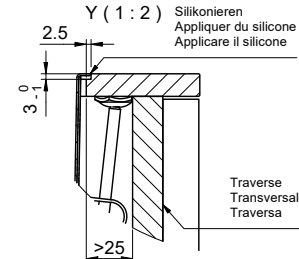
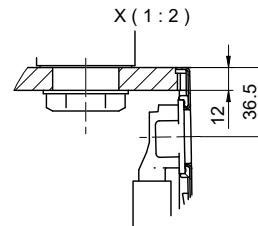

Für 13 - 30mm Arbeitsplatte.
 Pour plan de travail de 13 - 30mm.
 Per piano di lavoro da 13 - 30mm.

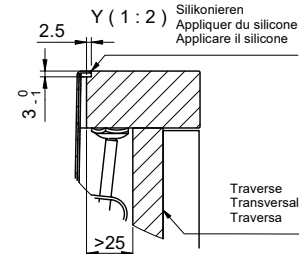
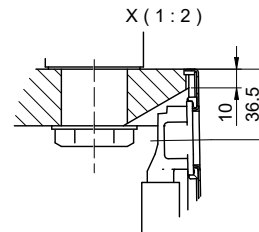

Für 13 - 50mm Arbeitsplatte.
 Pour plan de travail de 13 - 50mm.
 Per piano di lavoro da 13 - 50mm.

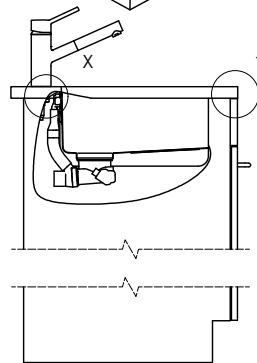
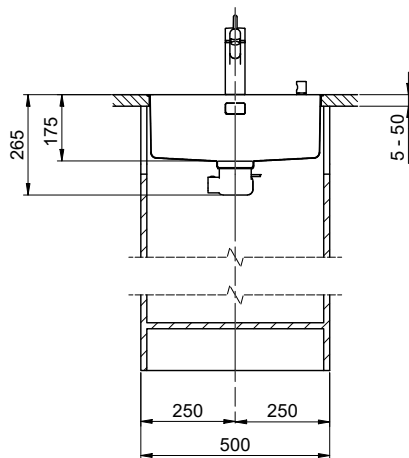
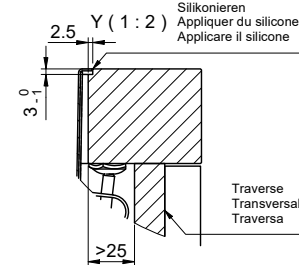
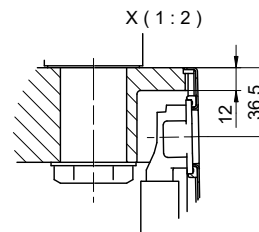

Bei der Planung die Traverse im Möbel beachten!

Faites attention à la barre transversale dans les meubles lors de la planification!

Presta attenzione alla traversa nei mobili durante la pianificazione!

Vom flächenbündigen Einbau in beschichtete Spanplatten raten wir ab.

Nous vous déconseillons le montage à fleur sur des panneaux de particules enduits.

Sconsigliamo il montaggio a filo top in pannelli di truciolato laminato.

Linero LIO 45F/7 Desino

Ausschnitt für flächenbündigen Einbau - Randbreite 7mm:
Mesure de coupure pour montage à fleur - Bord de 7mm de largeur:
Intaglio per montaggio a filo top - Larghezza bordo 7mm:

Bohrung für Zug- und Druckknöpfe Ø14
 Bohrung für Drehknopf Ø25

Trou pour boutons et Pousoirs de commande Ø14
 Trou pour bouton rotatif Ø25

Foro per Pomelli tiranti e Pomelli pulsanti Ø14
 Foro per Pomolo girevoli Ø25

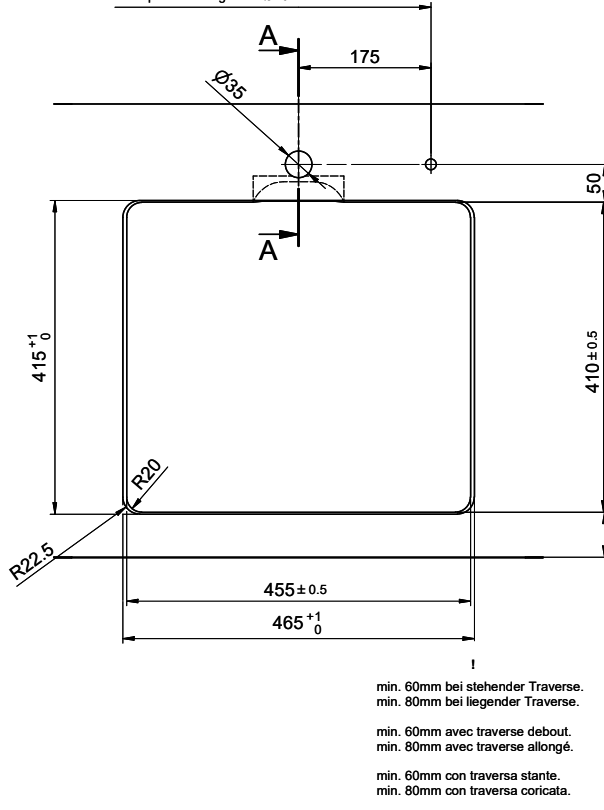

Für 12mm Arbeitsplatte.
 Pour plan de travail de 12mm.
 Per piano di lavoro da 12mm.

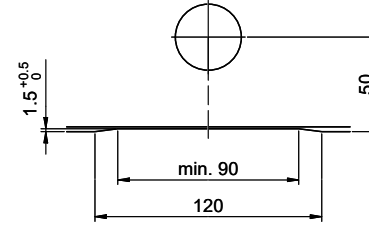

A-A (1 : 2)

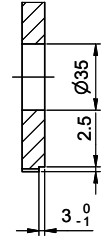

Für 13 - 30mm Arbeitsplatte.
 Pour plan de travail de 13 - 30mm.
 Per piano di lavoro da 13 - 30mm.

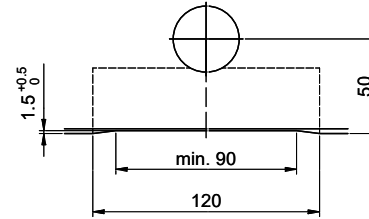

A-A (1 : 2)

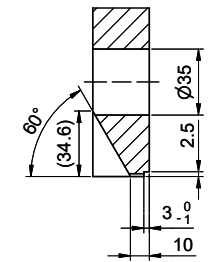

Für 13 - 50mm Arbeitsplatte.
 Pour plan de travail de 13 - 50mm.
 Per piano di lavoro da 13 - 50mm.

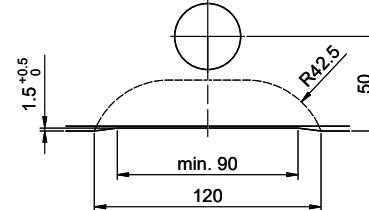

A-A (1 : 2)

